

TABLE OF CONTENTS

I. DOOR CLOSERS

GRADE 1

900 Series	1
CR441 Series	1
Parts & Accessories	1

II. LOCKSETS

GRADE 1

NM Series	2-9
SC Series	10-12
Genesys Series	13-14

GRADE 2

Pioneer Series	15
Grand Series	16
Challenger Series	17
Barrington Series	17
JHIL Series	18
CIL Series	19
IND90-G2 Series	21
T300 Series	20
SQ300 Series	20

GRADE 3

T220 & T330 Series	20
INDLEV-20 Series (Commercial Grade)	21
Chelsie Series	22
Heritage Series	23
Contemporary Series	24
Summit Series	25
Legacy Series	26
Clipper Series	27
Italia Series	28-30

III. HINGES

Commercial, Standard Weight	31
Residential, Residential Weight	31
Spring Hinges, Standard Weight	31
Electrified, Standard Weight	32
3D Invisible Hinges	32

IV. EXIT DEVICES

GRADE 1

7700 Series	33
Rose and Escutcheon Trims	33
9800 Series	34
Rose and Escutcheon Trims	34
2200 Series	35
Rose Trims	35

V. BUILDERS HARDWARE

Numbers and Letters	36
Miscellaneous Door and Window Hardware	36
Kick Plates	36
Push / Pull Plates	37
Door Pulls	37
Door Viewers	38
Door Guards	38
Sliding Door Locks	39
Security Bolts	39
Automatic Flushbolts	40
Combination Flushbolts	41
Universal Flushbolts	42
Door Coordinators	43
Handrail Brackets	43
Wall Door Stops / Bumpers	44
Floor Door Stops	44-45
Hinge Pin Door Stops	45
Closet Hardware	46
Handicap Restroom Signs (ADA) with Braille	47-48
Decals & Stickers	48
SDH Series (Sliding Door Hardware)	49
BDH Series (Sliding Door Hardware)	49-50
Sliding Door Hardware Accessories	51-53

DOOR CLOSERS

900 Series Door Closer

ILLUSTRATION	ITEM #	DESCRIPTION	PCS / MC	UNIT
	N900PBF L1	Barrier free, (Interior & Exterior) Adjustable size 1-6, door weights 30-260 lbs (Full Cover)	6	Ea.
	N900PBFDA L1	Barrier Free, Adjustable size 1-6, door weights 30-260 lbs with Delay Action (Interior & Exterior) (Full Cover)		

441 Series Door Closer

ILLUSTRATION	ITEM #	DESCRIPTION	PCS / MC	UNIT
	CR441 L1	Barrier free, Adjustable size 1-6 door weights 30-260 lbs (Full Cover) with Back Check	4	Ea.
	CR441DA L1	Barrier free, Adjustable size 1-6 door weights 30-260 lbs with Delay Action (Full Cover) No Back Check		
	CR441DABC L1	Barrier free, Adjustable size 1-6 door weights 30-260 lbs (Full Cover) with Delay Action & Back Check		

► PARTS & ACCESSORIES

STANDARD DISCOUNT ONLY				
ILLUSTRATION	ITEM #	DESCRIPTION	PCS / MC	UNIT
	901/902 L1	Hold open arm with parallel bracket, non-handed with stop in soffit shoe		Ea.
	CR3049HO L1	Non-handed hold-open arm with parallel bracket. Equivalent to LCN 3049		

NM Series *List Price*

HEAVY DUTY, GRADE 1 MORTISE LOCKSET

•• Optional Interchangeable Core Small Format (Best, Falcon and Arrow) or Large Format (Schlage)

QUANTITY DISCOUNT
 UP TO 30 UNITS MIXED - STANDARD DISCOUNT
 31-60 UNITS MIXED - LESS 5%
 61 & MORE UNITS MIXED - LESS 10%

ALL ITEMS BELOW AVAILABLE WITH FACTORY LEAD TIME AND SUBJECT TO MINIMUM ORDER QUANTITY

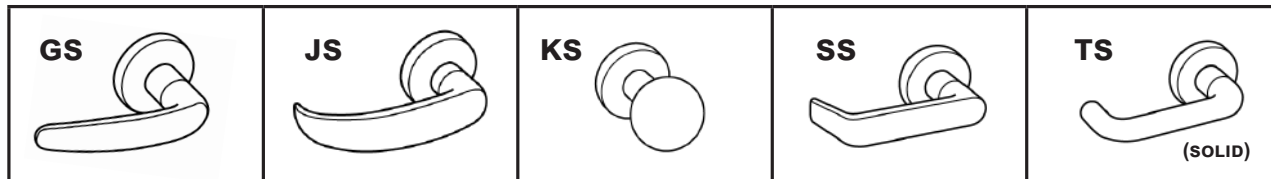

GS, JS, KS, SS, AND TS SECTIONAL TRIMS ONLY		
	FUNCTIONS	ANSI
Single cylinder without deadbolt	NM8050 - Office / Entrance	F04
	NM8056 - Office with Automatic Unlocking	----
	NM8070 - Classroom	F05
	NM8080 - Storeroom	F07
Single cylinder with deadbolt	NM8453 - Entrance	F20
	NM8456 - Corridor	F13
	NM8495 - Keyed Privacy with Indicator	----
	NM8465 - Closet / Storeroom with Deadbolt	----
	NM8473 - Dormitory / Bedroom	F21
Double cylinder without deadbolt	NM8480 - Storeroom with Deadbolt	----
	NM8071 - Classroom Security	F32
Double cylinder with deadbolt	NM8082 - Asylum / Institution	F30
	NM8457 - Classroom Security with Deadbolt	F33
	NM8458 - Classroom Security with Deadbolt and Auxiliary Latch	F34
Other Functions	NM8466 - Storeroom	F14
	NM8040 - Privacy Bedroom / Bath	F22
	NM8044 - Privacy with Coin Turn Outside	----
	NM8440 - Privacy with Deadbolt	F19
	NM8444 - Privacy with Deadbolt & Coin Turn Outside	F19A
	NM8445 - Privacy with Deadbolt, Coin Turn Outside and Indicator	F19B
	NM8010 - Passage	F01
	NM8170 - Single Fixed Dummy	----
	NM8172 - Double Fixed Dummy	----
NM8175 - Single Dummy with Lock Case	----	
NM8176 - Double Dummy with Lock Case	----	

•• All keyed lock functions are available with Best, Falcon and Arrow, Schlage, Corbin / Russwin, Sargent, and Yale Large Format Interchangeable Cores. Prices do not include cores.

NM Series *List Price*

HEAVY DUTY, GRADE 1 MORTISE LOCKSET

Optional Interchangeable Core Small Format (Best, Falcon and Arrow) or Large Format (Schlage)

QUANTITY DISCOUNT
UP TO 30 UNITS MIXED - STANDARD DISCOUNT
31-60 UNITS MIXED - LESS 5%
61 & MORE UNITS MIXED - LESS 10%

ALL ITEMS BELOW AVAILABLE WITH FACTORY LEAD TIME AND SUBJECT TO MINIMUM ORDER QUANTITY

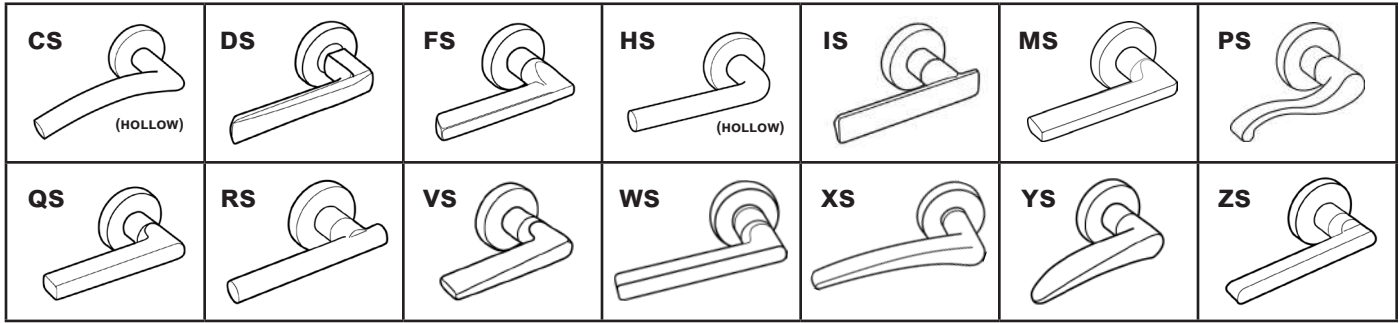

CS, DS, FS, HS, IS, MS, PS, QS, RS, VS, WS, XS, YS, AND ZS SECTIONAL TRIMS ONLY

FUNCTIONS		ANSI
Single cylinder without deadbolt	NM8050 - Office / Entrance	F04
	NM8056 - Office with Automatic Unlocking	----
	NM8070 - Classroom	F05
	NM8080 - Storeroom	F07
Single cylinder with deadbolt	NM8453 - Entrance	F20
	NM8456 - Corridor	F13
	NM8495 - Keyed Privacy with Indicator	----
	NM8465 - Closet / Storeroom with Deadbolt	----
	NM8473 - Dormitory / Bedroom	F21
Double cylinder without deadbolt	NM8480 - Storeroom with Deadbolt	----
	NM8071 - Classroom Security	F32
Double cylinder with deadbolt	NM8082 - Asylum / Institution	F30
	NM8457 - Classroom Security with Deadbolt	F33
	NM8458 - Classroom Security with Deadbolt and Auxiliary Latch	F34
Other Functions	NM8466 - Storeroom	F14
	NM8040 - Privacy Bedroom / Bath	F22
	NM8044 - Privacy with Coin Turn Outside	----
	NM8440 - Privacy with Deadbolt	F19
	NM8444 - Privacy with Deadbolt & Coin Turn Outside	F19A
	NM8445 - Privacy with Deadbolt, Coin Turn Outside and Indicator	F19B
	NM8010 - Passage	F01
	NM8170 - Single Fixed Dummy	----
	NM8172 - Double Fixed Dummy	----
	NM8175 - Single Dummy with Lock Case	----
NM8176 - Double Dummy with Lock Case	----	

Optional Interchangeable Cores. All keyed lock functions are available with Best, Falcon and Arrow, Schlage, Corbin / Russwin, Sargent, and Yale Large Format Interchangeable Cores. Prices do not include cores.

NM Series *List Price*

HEAVY DUTY, GRADE 1 MORTISE LOCKSET

88 Optional Interchangeable Core Small Format (Best, Falcon and Arrow) or Large Format (Schlage)

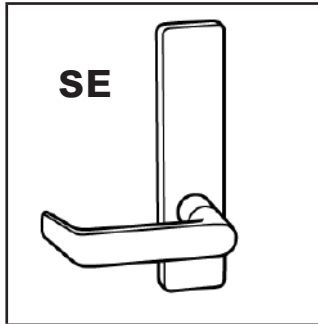

ALL ITEMS BELOW AVAILABLE WITH FACTORY LEAD TIME AND SUBJECT TO MINIMUM ORDER QUANTITY

QUANTITY DISCOUNT
 UP TO 30 UNITS MIXED - STANDARD DISCOUNT
 31-60 UNITS MIXED - LESS 5%
 61 & MORE UNITS MIXED - LESS 10%

SE ESCUTCHEON TRIM ONLY		
	FUNCTIONS	ANSI
Single cylinder without deadbolt	NM8050 - Office / Entrance	F04
	NM8056 - Office with Automatic Unlocking	----
	NM8070 - Classroom	F05
	NM8080 - Storeroom	F07
Single cylinder with deadbolt	NM8453 - Entrance	F20
	NM8456 - Corridor	F13
	NM8495 - Keyed Privacy with Indicator	----
	NM8465 - Closet / Storeroom with Deadbolt	----
	NM8473 - Dormitory / Bedroom	F21
	NM8480 - Storeroom with Deadbolt	----
Double cylinder without deadbolt	NM8071 - Classroom Security	F32
	NM8082 - Asylum / Institution	F30
Double cylinder with deadbolt	NM8457 - Classroom Security with Deadbolt	F33
	NM8458 - Classroom Security with Deadbolt and Auxiliary Latch	F34
	NM8466 - Storeroom	F14
Other Functions	NM8040 - Privacy Bedroom / Bath	F22
	NM8044 - Privacy with Coin Turn Outside	----
	NM8440 - Privacy with Deadbolt	F19
	NM8444 - Privacy with Deadbolt & Coin Turn Outside	F19A
	NM8445 - Privacy with Deadbolt, Coin Turn Outside and Indicator	F19B
	NM8010 - Passage	F01
	NM8170 - Single Fixed Dummy	----
	NM8172 - Double Fixed Dummy	----
	NM8175 - Single Dummy with Lock Case	----
NM8176 - Double Dummy with Lock Case	----	

88 All keyed lock functions are available with Best, Falcon and Arrow, Schlage, Corbin / Russwin, Sargent, and Yale Large Format Interchangeable Cores. Prices do not include cores.

NM Series *List Price*

HEAVY DUTY, GRADE 1 MORTISE LOCKSET

Optional Interchangeable Core Small Format (Best, Falcon and Arrow) or Large Format (Schlage)

QUANTITY DISCOUNT
UP TO 30 UNITS MIXED - STANDARD DISCOUNT
31-60 UNITS MIXED - LESS 5%
61 & MORE UNITS MIXED - LESS 10%

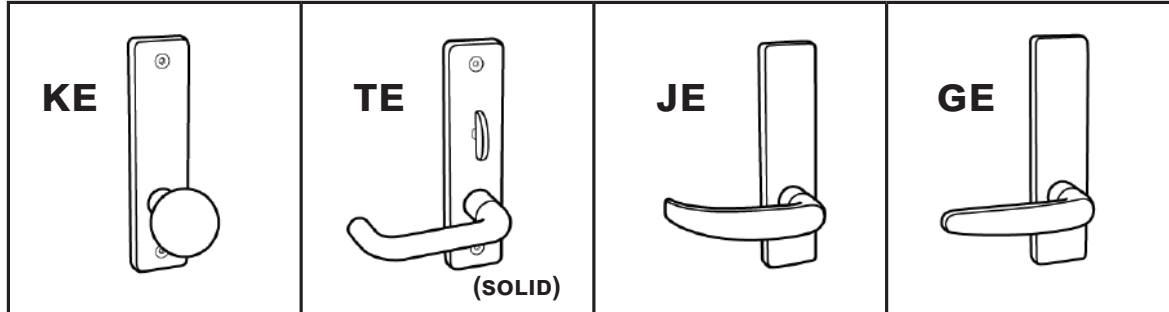

ALL ITEMS BELOW AVAILABLE WITH FACTORY LEAD TIME AND SUBJECT TO MINIMUM ORDER QUANTITY

KE, TE, JE, AND GE ESCUTCHEON TRIMS ONLY		
	FUNCTIONS	ANSI
Single cylinder without deadbolt	NM8050 - Office / Entrance	F04
	NM8056 - Office with Automatic Unlocking	----
	NM8070 - Classroom	F05
	NM8080 - Storeroom	F07
Single cylinder with deadbolt	NM8453 - Entrance	F20
	NM8456 - Corridor	F13
	NM8495 - Keyed Privacy with Indicator	----
	NM8465 - Closet / Storeroom with Deadbolt	----
	NM8473 - Dormitory / Bedroom	F21
Double cylinder without deadbolt	NM8480 - Storeroom with Deadbolt	----
	NM8071 - Classroom Security	F32
Double cylinder with deadbolt	NM8082 - Asylum / Institution	F30
	NM8457 - Classroom Security with Deadbolt	F33
	NM8458 - Classroom Security with Deadbolt and Auxiliary Latch	F34
	NM8466 - Storeroom	F14
Other Functions	NM8040 - Privacy Bedroom / Bath	F22
	NM8044 - Privacy with Coin Turn Outside	----
	NM8440 - Privacy with Deadbolt	F19
	NM8444 - Privacy with Deadbolt & Coin Turn Outside	F19A
	NM8445 - Privacy with Deadbolt, Coin Turn Outside and Indicator	F19B
	NM8010 - Passage	F01
	NM8170 - Single Fixed Dummy	----
	NM8172 - Double Fixed Dummy	----
	NM8175 - Single Dummy with Lock Case	----
NM8176 - Double Dummy with Lock Case	----	

Optional Interchangeable Cores. All keyed lock functions are available with Best, Falcon and Arrow, Schlage, Corbin / Russwin, Sargent, and Yale Large Format Interchangeable Cores. Prices do not include cores.

NM Series *List Price*

HEAVY DUTY, GRADE 1 MORTISE LOCKSET

88 Optional Interchangeable Core Small Format (Best, Falcon and Arrow) or Large Format (Schlage)

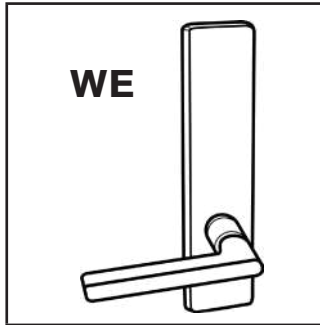

QUANTITY DISCOUNT
 UP TO 30 UNITS MIXED - STANDARD DISCOUNT
 31-60 UNITS MIXED - LESS 5%
 61 & MORE UNITS MIXED - LESS 10%

STOCK ITEMS IN BOLD.
 NON-STOCK FINISHES AND DESIGNS AVAILABLE WITH
 FACTORY LEAD TIME AND SUBJECT TO MINIMUM ORDER

WE ESCUTCHEON TRIM ONLY		
	FUNCTIONS	ANSI
Single cylinder without deadbolt	NM8050 - Office / Entrance	F04
	NM8056 - Office with Automatic Unlocking	----
	NM8070 - Classroom	F05
	NM8080 - Storeroom	F07
Single cylinder with deadbolt	NM8453 - Entrance	F20
	NM8456 - Corridor	F13
	NM8495 - Keyed Privacy with Indicator	----
	NM8465 - Closet / Storeroom with Deadbolt	----
	NM8473 - Dormitory / Bedroom	F21
	NM8480 - Storeroom with Deadbolt	----
Double cylinder without deadbolt	NM8071 - Classroom Security	F32
	NM8082 - Asylum / Institution	F30
Double cylinder with deadbolt	NM8457 - Classroom Security with Deadbolt	F33
	NM8458 - Classroom Security with Deadbolt and Auxiliary Latch	F34
	NM8466 - Storeroom	F14
Other Functions	NM8040 - Privacy Bedroom / Bath	F22
	NM8044 - Privacy with Coin Turn Outside	----
	NM8440 - Privacy with Deadbolt	F19
	NM8444 - Privacy with Deadbolt & Coin Turn Outside	F19A
	NM8445 - Privacy with Deadbolt, Coin Turn Outside and Indicator	F19B
	NM8010 - Passage	F01
	NM8170 - Single Fixed Dummy	----
	NM8172 - Double Fixed Dummy	----
NM8175 - Single Dummy with Lock Case	----	
NM8176 - Double Dummy with Lock Case	----	

88 All keyed lock functions are available with Best, Falcon and Arrow, Schlage, Corbin / Russwin, Sargent, and Yale Large Format Interchangeable Cores. Prices do not include cores.

NM Series *List Price*

HEAVY DUTY, GRADE 1 MORTISE LOCKSET

Optional Interchangeable Core Small Format (Best, Falcon and Arrow) or Large Format (Schlage)

QUANTITY DISCOUNT
UP TO 30 UNITS MIXED - STANDARD DISCOUNT
31-60 UNITS MIXED - LESS 5%
61 & MORE UNITS MIXED - LESS 10%

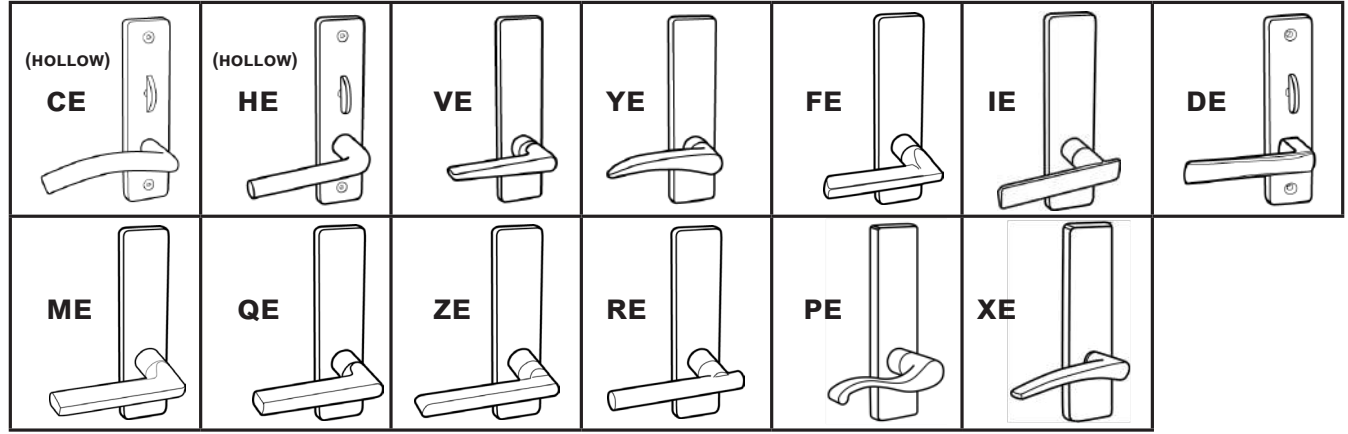

ALL ITEMS BELOW AVAILABLE WITH FACTORY LEAD TIME AND SUBJECT TO MINIMUM ORDER QUANTITY

CE, HE, VE, YE, FE, IE, DE, ME, QE, ZE, RE, PE, AND XE ESCUTCHEON TRIMS ONLY

	FUNCTIONS	ANSI
Single cylinder without deadbolt	NM8050 - Office / Entrance	F04
	NM8056 - Office with Automatic Unlocking	----
	NM8070 - Classroom	F05
	NM8080 - Storeroom	F07
Single cylinder with deadbolt	NM8453 - Entrance	F20
	NM8456 - Corridor	F13
	NM8495 - Keyed Privacy with Indicator	----
	NM8465 - Closet / Storeroom with Deadbolt	----
	NM8473 - Dormitory / Bedroom	F21
Double cylinder without deadbolt	NM8480 - Storeroom with Deadbolt	----
	NM8071 - Classroom Security	F32
Double cylinder with deadbolt	NM8082 - Asylum / Institution	F30
	NM8457 - Classroom Security with Deadbolt	F33
	NM8458 - Classroom Security with Deadbolt and Auxiliary Latch	F34
	NM8466 - Storeroom	F14
Other Functions	NM8040 - Privacy Bedroom / Bath	F22
	NM8044 - Privacy with Coin Turn Outside	----
	NM8440 - Privacy with Deadbolt	F19
	NM8444 - Privacy with Deadbolt & Coin Turn Outside	F19A
	NM8445 - Privacy with Deadbolt, Coin Turn Outside and Indicator	F19B
	NM8010 - Passage	F01
	NM8170 - Single Fixed Dummy	----
	NM8172 - Double Fixed Dummy	----
	NM8175 - Single Dummy with Lock Case	----
NM8176 - Double Dummy with Lock Case	----	

Optional Interchangeable Cores. Prices do not include cores.

WI Series *List Price*

HEAVY DUTY, GRADE 1 WIDE ESCUTCHEON MORTISE LOCKSET

Optional Interchangeable Core Small Format (Best, Falcon and Arrow) or Large Format (Schlage)

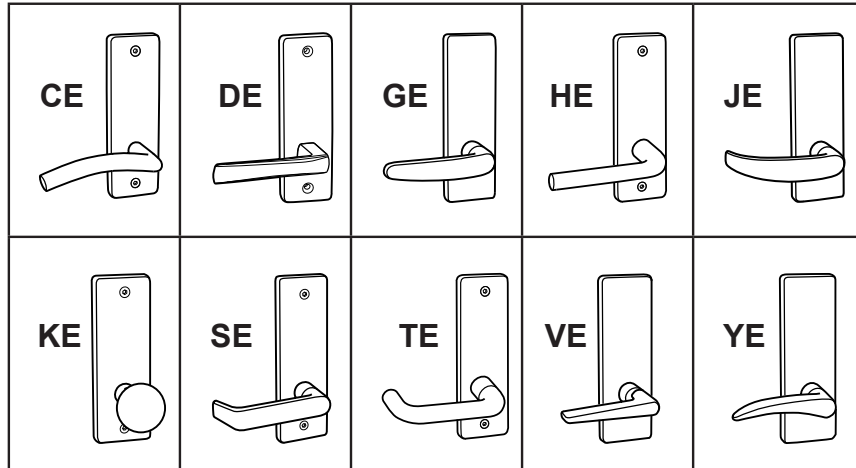

QUANTITY DISCOUNT
UP TO 30 UNITS MIXED -
STANDARD DISCOUNT
31-60 UNITS MIXED
- LESS 5%
61 & MORE UNITS MIXED
- LESS 10%

ALL ITEMS BELOW AVAILABLE WITH
FACTORY LEAD TIME AND SUBJECT
TO MINIMUM ORDER QUANTITY

WIDE ESCUTCHEON CE, DE, GE, HE, JE, KE, SE, TE, VE, YE TRIMS ONLY

	FUNCTIONS	ANSI
Single cylinder without deadbolt	WI8050 - Office / Entrance	F04
	WI8056 - Office with Automatic Unlocking	----
	WI8070 - Classroom	F05
	WI8080 - Storeroom	F07
Single cylinder with deadbolt	WI8453 - Entrance	F20
	WI8456 - Corridor	F13
	WI8495 - Keyed Privacy with Indicator	----
	WI8465 - Closet / Storeroom with Deadbolt	----
	WI8473 - Dormitory / Bedroom	F21
Double cylinder without deadbolt	WI8480 - Storeroom with Deadbolt	----
	WI8071 - Classroom Security	F32
Double cylinder with deadbolt	WI8082 - Asylum / Institution	F30
	WI8457 - Classroom Security with Deadbolt	F33
	WI8458 - Classroom Security with Deadbolt and Auxiliary Latch	F34
Other Functions	WI8466 - Storeroom	F14
	WI8040 - Privacy Bedroom / Bath	F22
	WI8044 - Privacy with Coin Turn Outside	----
	WI8440 - Privacy with Deadbolt	F19
	WI8444 - Privacy with Deadbolt and Coin Turn Outside	F19A
	WI8445 - Privacy with Deadbolt, Coin Turn and Indicator	F19B
	WI8010 - Passage	F01
	WI8170 - Single Fixed Dummy	----
	WI8172 - Double Fixed Dummy	----
	WI8175 - Single Dummy with Lock Case	----
WI8176 - Double Dummy with Lock Case	----	

Optional Interchangeable Cores. All keyed lock functions are available with Best, Falcon and Arrow, Schlage, Corbin / Russwin, Sargent, and Yale Large Format Interchangeable Cores. Prices do not include cores.

NM Series *List Price*

HEAVY DUTY, GRADE 1 MORTISE DEADBOLTS

Optional Interchangeable Core Small Format (Best, Falcon and Arrow) or Large Format (Schlage)

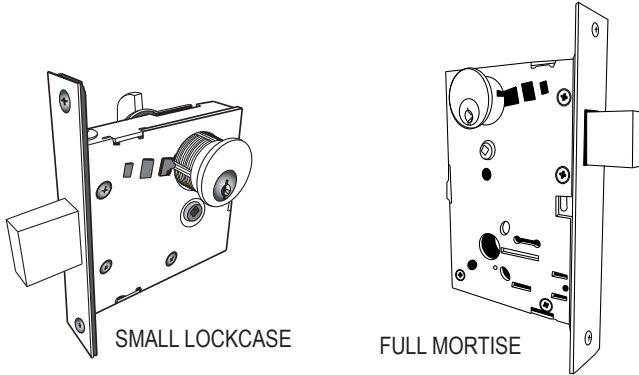

SMALL LOCKCASE

FULL MORTISE

**ALL ITEMS BELOW AVAILABLE WITH
FACTORY LEAD TIME AND SUBJECT
TO MINIMUM ORDER QUANTITY**

QUANTITY DISCOUNT
UP TO 30 UNITS MIXED - STANDARD DISCOUNT
31-60 UNITS MIXED - LESS 5%
61 & MORE UNITS MIXED - LESS 10%

MODEL#	ANSI	US19	FUNCTIONS	MODEL#	ANSI
 SM4608	E06071	\$99.25	Cylinder and Thumbturn Deadbolt thrown or retracted by key outside or thumbturn inside.	 M8460	F17
 SM4628	E06061	110.25	Double Cylinder Deadbolt operated by key on either side.	 M8462	F16
 SM4638	E06091	110.25	Classroom Lock Deadbolt thrown or retracted by key from outside. Inside thumbturn cylinder retracts deadbolt but cannot project it.	 M8463	F29
 SM4648	E06081	93.70	Cylinder Lock Deadbolt thrown or retracted by key from outside only. No trim on opposite side.	 M8464	F18
 SM4808	---	88.35	Door Bolt Deadbolt thrown or retracted by thumbturn from one side. No trim on opposite side.	 M8480	---
 SM4968	---	186.40	Deadbolt with "OCCUPIED" indicator. Deadbolt thrown or retracted by key outside or thumbturn inside. "OCCUPIED" plate is displayed when deadbolt is thrown.	 M8496	---

Optional Interchangeable Cores. All keyed lock functions are available with Best, Falcon and Arrow, Schlage, Corbin / Russwin, Sargent, and Yale Large Format Interchangeable Cores. Prices do not include cores.

SC Series *List Price*

HEAVY DUTY, GRADE 1 MORTISE LOCKSET

Optional Interchangeable Core Small Format (Best, Falcon and Arrow) or Large Format (Schlage)

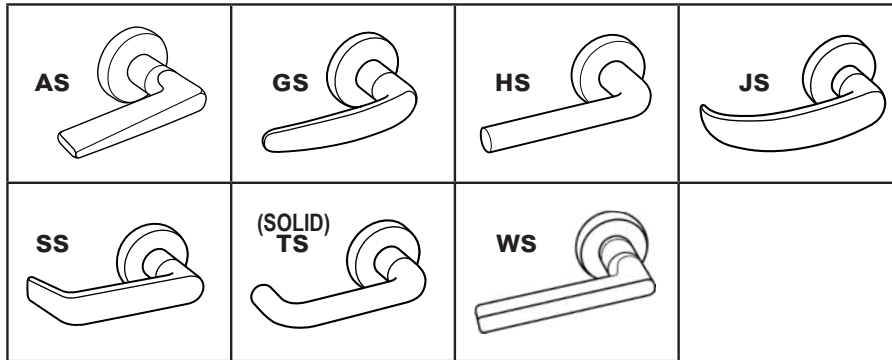

ALL ITEMS BELOW AVAILABLE WITH FACTORY LEAD TIME AND SUBJECT TO MINIMUM ORDER QUANTITY

QUANTITY DISCOUNT
 UP TO 30 UNITS MIXED - STANDARD DISCOUNT
 31-60 UNITS MIXED - LESS 5%
 61 & MORE UNITS MIXED - LESS 10%

AS, GS, HS, JS, SS, TS, AND WS SECTIONAL TRIMS ONLY

	FUNCTIONS	ANSI
Single cylinder without deadbolt	SC8050 - Office / Entrance	F04
	SC8056 - Office with Automatic Unlocking	----
	SC8070 - Classroom	F05
	SC8076 - Classroom Hold-Back	F06
	SC8080 - Storeroom	F07
Single cylinder with deadbolt	SC8453 - Entrance	F20
	SC8456 - Corridor	F13
	SC8465 - Closet / Storeroom with Deadbolt	----
	SC8495 - Keyed Privacy with Indicator	----
	SC8485 - Faculty Restroom	----
	SC8486 - Faculty Restroom with Indicator	----
	SC8473 - Dormitory / Bedroom	F21
Double cylinder without deadbolt	SC8480 - Storeroom with Deadbolt	----
	SC8060 - Apartment Entrance	F09
	SC8082 - Asylum / Institution	F30
	SC8071 - Classroom Security	F32
Double cylinder with deadbolt	SC8077 - Classroom Security Hold-Back	----
	SC8466 - Store Door Lock	F14
	SC8457 - Classroom Security with Deadbolt	F33
Other Functions	SC8458 - Classroom Security with Deadbolt and Auxiliary Latch	F34
	SC8040 - Privacy Bedroom / Bath	F22
	SC8044 - Privacy with Coin Turn Outside	----
	SC8440 - Privacy with Deadbolt	F19
	SC8444 - Privacy with Deadbolt & Coin Turn Outside	F19A
	SC8445 - Privacy with Deadbolt, Coin Turn Outside and Indicator	F19B
	SC8010 - Passage	F01
	SC8170 - Single Fixed Dummy	----
	SC8172 - Double Fixed Dummy	----
	SC8175 - Single Dummy with Lock Case	----
SC8176 - Double Dummy with Lock Case	----	

Optional Interchangeable Cores. All keyed lock functions are available with Best, Falcon and Arrow, Schlage, Corbin / Russwin, Sargent, and Yale Large Format Interchangeable Cores. Prices do not include cores.

SC Series *List Price*

HEAVY DUTY, GRADE 1 WIDE ESCUTCHEON MORTISE LOCKSET

Optional Interchangeable Core Small Format (Best, Falcon and Arrow) or Large Format (Schlage)

QUANTITY DISCOUNT

UP TO 30 UNITS MIXED - STANDARD DISCOUNT

31-60 UNITS MIXED - LESS 5%

61 & MORE UNITS MIXED - LESS 10%

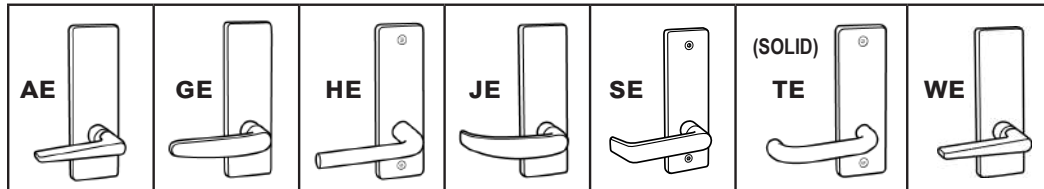

ALL ITEMS BELOW AVAILABLE WITH FACTORY LEAD TIME AND SUBJECT TO MINIMUM ORDER QUANTITY

AE, GE, HE, JE, SE, TE, AND WE WIDE ESCUTCHEON TRIMS ONLY

	FUNCTIONS	ANSI
Single cylinder without deadbolt	SC8050 - Office / Entrance	F04
	SC8056 - Office with Automatic Unlocking	----
	SC8070 - Classroom	F05
	SC8076 - Classroom Hold-Back	F06
	SC8080 - Storeroom	F07
Single cylinder with deadbolt	SC8453 - Entrance	F20
	SC8456 - Corridor	F13
	SC8465 - Closet / Storeroom with Deadbolt	----
	SC8495 - Keyed Privacy with Indicator	----
	SC8485 - Faculty Restroom	----
	SC8486 - Faculty Restroom with Indicator	----
	SC8473 - Dormitory / Bedroom	F21
Double cylinder without deadbolt	SC8480 - Storeroom with Deadbolt	----
	SC8060 - Apartment Entrance	F09
	SC8082 - Asylum / Institution	F30
	SC8071 - Classroom Security	F32
Double cylinder with deadbolt	SC8077 - Classroom Security Hold-Back	----
	SC8466 - Store Door Lock	F14
	SC8457 - Classroom Security with Deadbolt	F33
Other Functions	SC8458 - Classroom Security with Deadbolt and Auxiliary Latch	F34
	SC8040 - Privacy Bedroom / Bath	F22
	SC8044 - Privacy with Coin Turn Outside	----
	SC8440 - Privacy with Deadbolt	F19
	SC8444 - Privacy with Deadbolt & Coin Turn Outside	F19A
	SC8445 - Privacy with Deadbolt, Coin Turn Outside and Indicator	F19B
	SC8010 - Passage	F01
	SC8170 - Single Fixed Dummy	----
SC8172 - Double Fixed Dummy	----	
	SC8175 - Single Dummy with Lock Case	----
	SC8176 - Double Dummy with Lock Case	----

Optional Interchangeable Cores. All keyed lock functions are available with Best, Falcon and Arrow, Schlage, Corbin / Russwin, Sargent, and Yale Large Format Interchangeable Cores. Prices do not include cores.

SC Series *List Price*

HEAVY DUTY, GRADE 1 MORTISE DEADBOLTS

•• Optional Interchangeable Core Small Format (Best, Falcon and Arrow) or Large Format (Schlage)

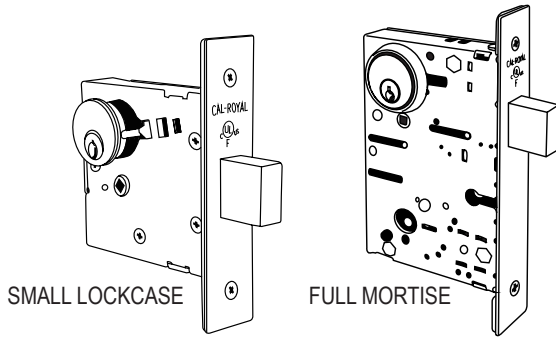

**ALL ITEMS BELOW AVAILABLE WITH
FACTORY LEAD TIME AND SUBJECT
TO MINIMUM ORDER QUANTITY**

QUANTITY DISCOUNT
UP TO 30 UNITS MIXED - STANDARD DISCOUNT
31-60 UNITS MIXED - LESS 5%
61 & MORE UNITS MIXED - LESS 10%

MODEL#	ANSI	US19	FUNCTIONS	MODEL#	ANSI
 SM140	---	\$99.25	Cylinder and Thumbturn Deadbolt thrown or retracted by key outside or thumbturn inside.	 SC8460	F17
 SM143	---	110.25	Double Cylinder Deadbolt operated by key on either side.	 SC8462	F16
 SM141	---	110.25	Classroom Lock Deadbolt thrown or retracted by key from outside. Inside thumbturn cylinder retracts deadbolt but cannot project it.	 SC8463	F29
 SM142	---	93.70	Cylinder Lock Deadbolt thrown or retracted by key from outside only. No trim on opposite side.	 SC8464	F18
 SM145	---	88.35	Door Bolt Deadbolt thrown or retracted by thumbturn from one side. No trim on opposite side.	 SC8461	---
 SM146	---	186.40	Deadbolt with "OCCUPIED" indicator Deadbolt thrown or retracted by key outside or thumbturn inside. "OCCUPIED" plate is displayed when deadbolt is thrown.	 SC8496	---

•• All keyed lock functions are available with Best, Falcon and Arrow, Schlage, Corbin / Russwin, Sargent, and Yale Large Format Interchangeable Cores. Prices do not include cores.

GENESYS Series *List Price*

**HEAVY DUTY CYLINDRICAL LEVERSETS WITH CLUTCH,
ANSI - A156.2, SERIES 4000, GRADE 1**

Optional Interchangeable Core for BEST, FALCON & ARROW

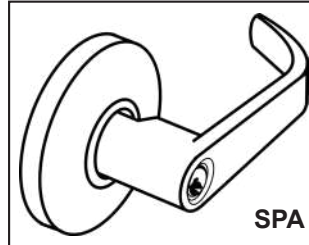
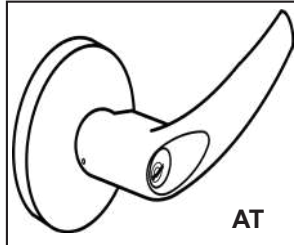
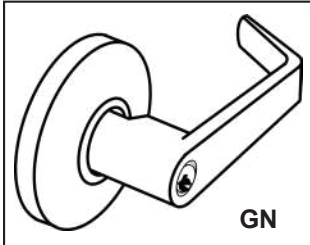

QUANTITY DISCOUNT
UP TO 30 UNITS MIXED -
STANDARD DISCOUNT
50 UNITS MIXED - LESS 5%
100 UNITS MIXED - LESS 10%

STOCK ITEMS IN BOLD.
NON-STOCK FINISHES AND DESIGNS AVAILABLE WITH FACTORY LEAD TIME
AND SUBJECT TO MINIMUM ORDER

FUNCTIONS	ANSI	ITEM#			PCS / MC
		CGN00	CAT00	CSPA00	
Entrance	F109	CGN00	CAT00	CSPA00	10
		Ⓢ ICCGN00	Ⓢ ICCAT00	Ⓢ ICCSPA00	
Entrance Push Button Lock	F82	CGN01	CAT01	CSPA01	
		Ⓢ ICCGN01	Ⓢ ICCAT01	Ⓢ ICCSPA01	
Store lock - Non Clutch (keyed Dbl. cyl.)	F91	GN02	AT02	SPA02	
		Ⓢ ICGN02	Ⓢ ICAT02	Ⓢ ICSPA02	
Classroom	F84	CGN03	CAT03	CSPA03	
		Ⓢ ICCGN03	Ⓢ ICCAT03	Ⓢ ICCSPA03	
Communicating (keyed Dbl. cyl.)	F80	CGN04	CAT04	CSPA04	
		Ⓢ ICCGN04	Ⓢ ICCAT04	Ⓢ ICCSPA04	
Storeroom	F86	CGN05	CAT05	CSPA05	
		Ⓢ ICCGN05	Ⓢ ICCAT05	Ⓢ ICCSPA05	
Vestibule	F88	CGN06	CAT06	CSPA06	
		Ⓢ ICCGN06	Ⓢ ICCAT06	Ⓢ ICCSPA06	
Classroom / Intruder	F110	CGN07	CAT07	CSPA07	
		Ⓢ ICCGN07	Ⓢ ICCAT07	Ⓢ ICCSPA07	
Dormitory (Non-Clutch)	F90	GN101	---		
Institution (keyed Dbl. cyl.)	F87	CGN09	CAT09	CSPA09	
		Ⓢ ICCGN09	Ⓢ ICCAT09	Ⓢ ICCSPA09	
Privacy	F76	CGN20	CAT20	CSPA20	
Hospital Privacy	---	HCGN20	HCAT20	HCSPA20	
Passage	F75	GN30	AT30	SPA30	
Exit	F89	GN50	AT50	SPA50	
Single Dummy	----	GN40	AT40	SPA40	20

Ⓢ (IC) Indicates function available with Best, Falcon and Arrow Interchangeable Core. Prices do not include cores.

GENESYS Series *List Price*

HEAVY DUTY CYLINDRICAL LEVERSETS WITH CLUTCH ANSI - A156.2, SERIES 4000, GRADE 1

QUANTITY DISCOUNT
UP TO 30 UNITS MIXED - STANDARD DISCOUNT
50 UNITS MIXED - LESS 5%
100 UNITS MIXED - LESS 10%

• Optional Interchangeable Core for **BEST, FALCON & ARROW**

• Optional Full Size Interchangeable Core for **SCHLAGE, SARGENT, CORBIN/RUSSWIN**

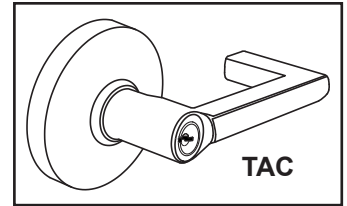
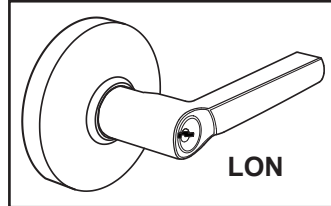
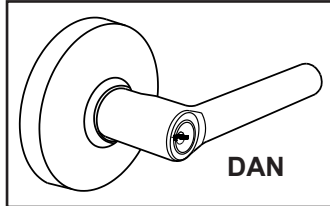
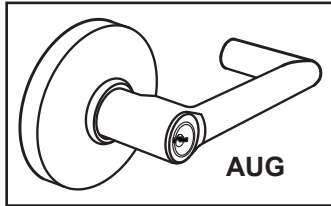

ALL ITEMS BELOW AVAILABLE WITH FACTORY LEAD TIME AND SUBJECT TO MINIMUM ORDER QUANTITY

FUNCTIONS	ANSI	ITEM #				PCS / MC
Entrance	F109	CAUG00	CDAN00	CLON00	CTAC00	10
		• • ICCAUG00	• • ICCDAN00	• • ICCLON00	• • ICTTAC00	
Entrance Push Button Lock	F82	CAUG01	CDAN01	CLON01	CTAC01	
		• ICCAUG01	• ICCDAN01	• ICCLON01	• ICTTAC01	
Store lock - Non Clutch (keyed Dbl. cyl.)	F91	AUG02	DAN02	LON02	TAC02	
		• ICAUG02	• ICDAN02	• ICLON02	• ICTTAC02	
Classroom	F84	CAUG03	CDAN03	CLON03	CTAC03	
		• ICCAUG03	• ICCDAN03	• ICCLON03	• ICTTAC03	
Communicating (keyed Dbl. cyl.)	F80	CAUG04	CDAN04	CLON04	CTAC04	
		• • ICCAUG04	• • ICCDAN04	• • ICCLON04	• • ICTTAC04	
Storeroom	F86	CAUG05	CDAN05	CLON05	CTAC05	
		• • ICCAUG05	• • ICCDAN05	• • ICCLON05	• • ICTTAC05	
Vestibule	F88	CAUG06	CDAN06	CLON06	CTAC06	
		• • ICCAUG06	• • ICCDAN06	• • ICCLON06	• • ICTTAC06	
Classroom / Intruder	F110	CAUG07	CDAN07	CLON07	CTAC07	
		• • ICCAUG07	• • ICCDAN07	• • ICCLON07	• • ICTTAC07	
Dormitory (Non-Clutch)	F90	• AUG101	• DAN101	• LON101	• TAC101	
Institution (keyed Dbl. cyl.)	F87	CAUG09	CDAN09	CLON09	CTAC09	
		• • ICCAUG09	• • ICCDAN09	• • ICCLON09	• • ICTTAC09	
Privacy	F76	CAUG20	CDAN20	CLON20	CTAC20	
Hospital Privacy	---	HCAUG20	HCDAN20	HCLON20	HCTAC20	
Passage	F75	AUG30	DAN30	LON30	TAC30	
Exit	F89	AUG50	DAN50	LON50	TAC50	
Single Dummy	----	AUG40	DAN40	LON40	TAC40	20

• (IC) Indicates function available with Best, Falcon and Arrow Interchangeable Core.

• (6 Pin Only) For Schlage LFIC, prefix "ICSC" before part #. Example: "CAUG00" with "ICSC", will be "ICSCCAUG00"

(6 Pin Only) For Sargent LFIC, prefix "SARIC" before part #. Example: "CAUG00" with "SARIC", will be "SARICCAUG00"

(6 or 7 Pin) For Corbin / Russwin LFIC, prefix "RUSIC" before part #. Example: "CAUG00" with "RUSIC", will be "RUSICCAUG00"

• Available functions: **00, 04, 05, 06, 07, 09, 101**

Prices do not include cores.

PIONEER SL Series *List Price*

HEAVY DUTY CYLINDRICAL LEVERSETS

ANSI - A156.2, Series 4000, Grade 2

Optional Interchangeable Core for BEST, FALCON & ARROW

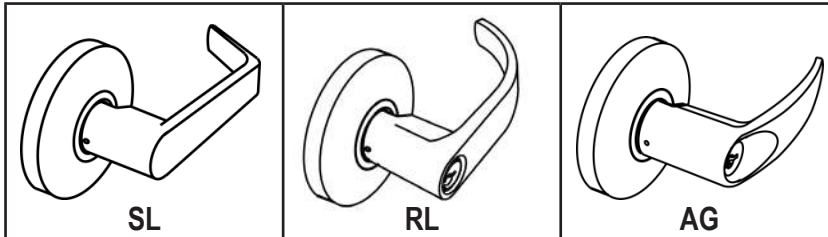

QUANTITY DISCOUNT
50 UNITS MIXED - LESS 5%
100 UNITS MIXED - LESS 10%

STOCK ITEMS IN BOLD.
 NON-STOCK FINISHES AND DESIGNS AVAILABLE WITH FACTORY LEAD TIME
 AND SUBJECT TO MINIMUM ORDER

FUNCTIONS	ANSI	SL SERIES	RL SERIES	AG SERIES	PCS/MC
Entrance	F109	SL00 US1	RL00 US1	AG00 US1	10
		ICSL00 US1	ICRL00 US1	ICAG00 US1	
Storeroom	F91	SL05 US1	RL05 US1	AG05 US1	
		ICSL05 US1	ICRL05 US1	ICAG05 US1	
Classroom	F84	SL03 US1	RL03 US1	AG03 US1	
		ICSL03 US1	ICRL03 US1	ICAG03 US1	
Entrance Push Button Lock	F82	SL01 US1	RL01 US1	AG01 US1	
		ICSL01 US1	ICRL01 US1	ICAG01 US1	
Exit Lock / Connecting Room with key	----	SL80 US1 ICSL80 US1	RL80 US1 ICRL80 US1	AG80 US1 ICAG80 US1	
Dormitory / Assisted Living	F90	SL101 US1 ICSL101 US1	RL101 US1 ICRL101 US1	AG101 US1 ICAG101 US1	
Privacy	F76	SL20 US1	RL20 US1	AG20 US1	
Patio	F77	SL10 US1	RL10 US1	----	
Passage	F75	SL30 US1	RL30 US1	AG30 US1	
Exit	F89	SL50 US1	RL50 US1	AG50 US1	
Single Dummy	----	SL40 US1	RL40 US1	AG40 US1	20

(IC) Indicates function available with Best, Falcon and Arrow Interchangeable Core. Prices do not include cores.

GRAND Series *List Price*

STANDARD DUTY TUBULAR LEVERSETS

ANSI - A156.2, Series 4000, Grade 2



ALL ITEMS BELOW ARE AVAILABLE WITH FACTORY LEAD TIME AND SUBJECT TO MINIMUM ORDER QUANTITY. SAMPLES FOR SUBMITTAL ARE AVAILABLE IN US1 FINISH. CONSULT FACTORY.



***SH** Specify Handing for **GER** & **VAL** Designs
Specify R (Right) or L (Left) for convenience.
If handing is not available at time of shipment, opposite hand will be shipped. Other functions are non-handed.

FUNCTIONS	ANSI	ITEM #			PCS / MC
Privacy	F76	GER20	VAL20	FOR20	10
Passage	F75	GER30	VAL30	FOR30	
Dummy	---	GER40	VAL40	FOR40	20
Two Sided Dummy	---	GER70	VAL70	FOR70	10

QUANTITY DISCOUNT

50 UNITS MIXED - LESS 5%

100 UNITS MIXED - LESS 10%

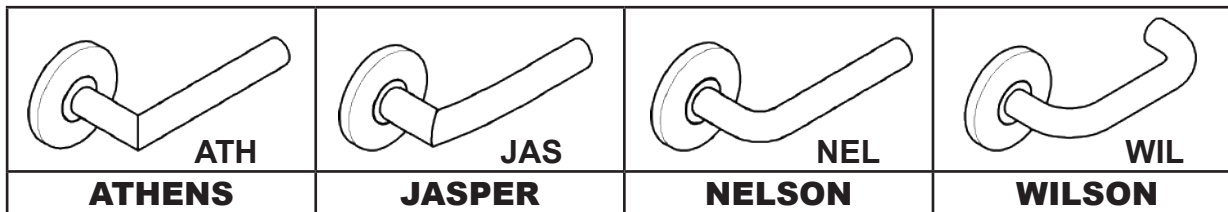

FUNCTIONS	ANSI	ITEM #				PCS / MC
Privacy	F76	ATH20	JAS20	NEL20	WIL20	10
Passage	F75	ATH30	JAS30	NEL30	WIL30	
Dummy	---	ATH40	JAS40	NEL40	WIL40	20
Two Sided Dummy	---	ATH70	JAS70	NEL70	WIL70	10

► **ADDITIONAL PARTS & CHARGES:** For 2" door thickness, add \$2.25 to List Price.

◆◆◆ STANDARD DISCOUNT ONLY ◆◆◆			
ILLUSTRATION	ITEM #	DESCRIPTION	FINISH
	GRD-234	2 3/4" Backset (Fixed) for Grand Series	US1
	GRD-238	2 3/8" Backset (Fixed) for Grand Series	
	GRD-PIN	Locking Pin for Privacy function only	
	TS	T-Strike	
	FLS	Full Lip Strike	
	ASAST	ASA Strike	

CHALLENGER ROC *List Price*

STANDARD DUTY CYLINDRICAL LEVERSETS
ANSI STANDARD A156.2, GRADE 2

Optional Interchangeable Core for **BEST, FALCON & ARROW**

QUANTITY DISCOUNT
50 UNITS MIXED - LESS 5%
100 UNITS MIXED - LESS 10%

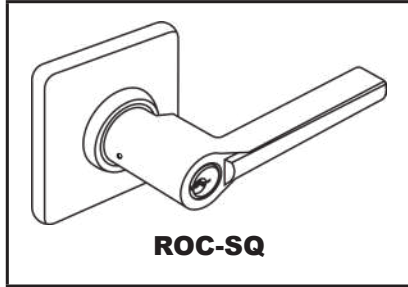

FUNCTIONS	ANSI	ITEM #	PCS / MC
Entrance	F109	ROC00-SQ US1	10
Storeroom	F91	ROC05-SQ US1	
Privacy	F76	ROC20-SQ US1	
Passage	F75	ROC30-SQ US1	
Dummy	---	ROC40-SQ US1	20

BARRINGTON TBA *List Price*

STANDARD DUTY CYLINDRICAL LEVERSETS
ANSI STANDARD A156.2, Series 4000 GRADE 2

Optional Interchangeable Core for **BEST, FALCON & ARROW**

QUANTITY DISCOUNT
50 UNITS MIXED - LESS 5%
100 UNITS MIXED - LESS 10%

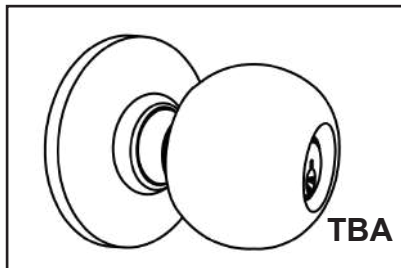

STOCK ITEMS IN BOLD.
NON-STOCK FINISHES AND DESIGNS AVAILABLE
WITH FACTORY LEAD TIME
AND SUBJECT TO MINIMUM ORDER.

<i>Made in Taiwan</i>			
FUNCTION	ANSI	ITEM #	PCS / MC
Entrance *****KA / 4	F109	TBA00 US19	20
		ICTBA00 US19	
Classroom	F84	TBA03 US19	
		ICTBA03 US19	
Storeroom	F86	TBA05 US19	
		ICTBA05 US19	
Storelock	F91	TBA02 US19	
Communicating	F80	TBA04 US19	
Institution	F87	TBA09 US19	
Privacy	F76	TBA20 US19	
Passage	F75	TBA30 US19	
Exit	F89	TBA50 US19	
Single Dummy	----	TBA40 US19	50

(IC) Indicates function available with Best, Falcon and Arrow Interchangeable Core. Prices do not include cores.

JHIL Series List Price

INTERCONNECTED LEVERSET

ANSI - A156.12 SERIES 5000, GRADE 2, UL LISTED

- Optional Interchangeable Core for Best, Falcon and Arrow
- Optional Large Format Interchangeable Core for Schlage with Interconnecting Mechanism, Can be used with 4" or 5 1/2" CTC

QUANTITY DISCOUNT
50 UNITS MIXED - LESS 5%
100 UNITS MIXED - LESS 10%

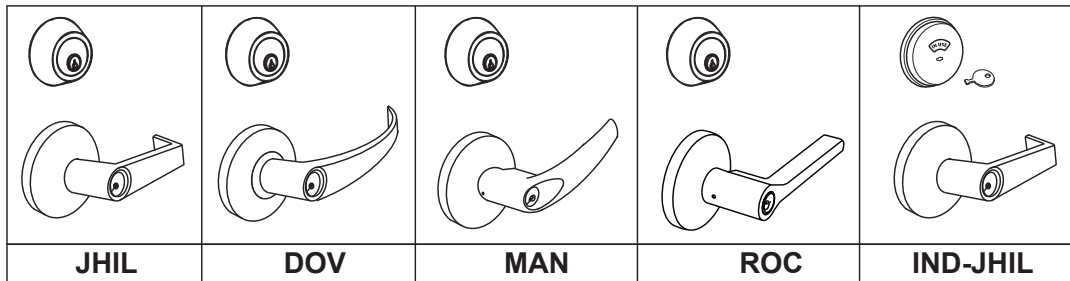

FUNCTION	ANSI	ITEM #	PCS / MC
Double Locking, Entrance Lever	F97	JHIL00	10
		●● ICJHIL00	
Double Locking, Storeroom Lever	F98	JHIL05	
		NEW ITEM	
Single Locking, Passage Lever	F95	JHIL30	
		● ICJHIL30	
		● ICSCJHIL30	
Double Locking, Entrance Lever	F97	JHILROC00	
		●● ICJHILROC00	
Single Locking, Passage Lever	F95	JHILROC30	
		● ICJHILROC30	
		● ICSCJHILROC30	
Double Locking, Entrance Lever	F97	JHILDOV00	
		●● ICJHILDOV00	
Single Locking, Passage Lever	F95	JHILDOV30	
		● ICJHILDOV30	
		● ICSCJHILDOV30	
Double Locking, Entrance Lever	F97	JHILMAN00	
		●● ICJHILMAN00	
Single Locking, Passage Lever	F95	JHILMAN30	
		● ICJHILMAN30	
		● ICSCJHILMAN30	
Indicator Deadbolt, Storeroom Lever	---	IND-JHIL05	10
		NEW ITEM	
Indicator Deadbolt, Passage Lever	---	IND-JHIL30	
		NEW ITEM	

STOCK ITEMS IN BOLD.
NON-STOCK FINISHES AND DESIGNS AVAILABLE WITH FACTORY LEAD TIME AND SUBJECT TO MINIMUM ORDER.

- (IC) Indicates deadbolt available with Interchangeable Core. Cores are compatible 6 or 7 pin with Best, Falcon and Arrow.
 - (ICSC) Indicates deadbolt available with Large Format Interchangeable Core for Schlage.
- Prices do not include cores.

CIL Series List Price

CONTEMPORARY INTERCONNECTED LOCKS ANSI - A156.12 SERIES 5000, GRADE 2, UL LISTED

with Interconnecting Mechanism, Can be used with 4" or 5 1/2" CTC

- Available with SFIC on **Deadbolt and Lever** (Entrance)
- Available with SFIC or LFIC on **Deadbolt** only (Lever Passage)

QUANTITY DISCOUNT
50 UNITS MIXED - LESS 5%
100 UNITS MIXED - LESS 10%

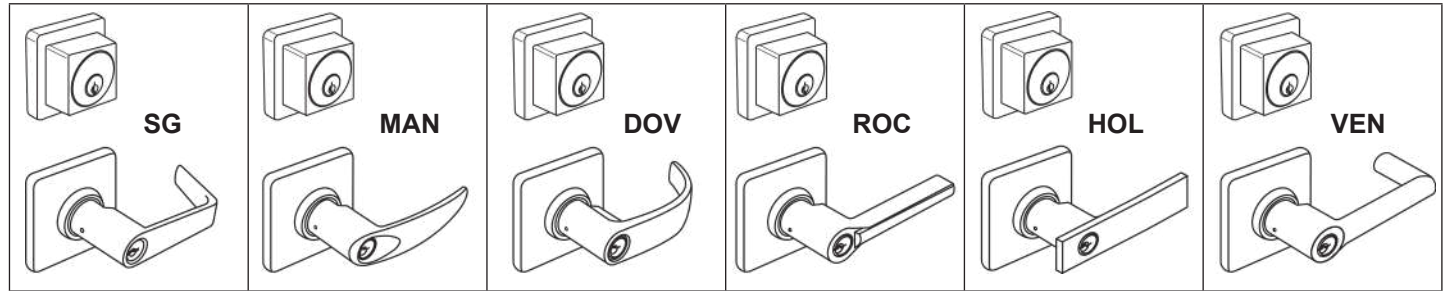

STOCK ITEMS IN BOLD
 NON-STOCK FINISHES AND DESIGNS AVAILABLE WITH FACTORY LEAD TIME AND SUBJECT TO MINIMUM ORDER.

FUNCTION	ANSI	ITEM #	PCS / MC
Double Locking, Entrance Lever	F97	CILSG00 US1	10
		●● ICCILSG00 US1	
Single Locking, Passage Lever	F95	CILSG30 US1	
		● ICCILSG30 US1	
		● ICSCCILSG30 US1	
Double Locking, Entrance Lever	F97	CILMAN00 US1	
		●● ICCILMAN00 US1	
Single Locking, Passage Lever	F95	CILMAN30 US1	
		● ICCILMAN30 US1	
		● ICSCCILMAN30 US1	
Double Locking, Entrance Lever	F97	CILDOV00 US1	
		●● ICCILDOV00 US1	
Single Locking, Passage Lever	F95	CILDOV30 US1	
		● ICCILDOV30 US1	
		● ICSCCILDOV30 US1	
Double Locking, Entrance Lever	F97	CILROC00 US1	
		●● ICCILROC00 US1	
Single Locking, Passage Lever	F95	CILROC30 US1	
		● ICCILROC30 US1	
		● ICSCCILROC30 US1	
Double Locking, Entrance Lever	F97	CILHOL00 US1	
		CILHOL30 US1	
Single Locking, Passage Lever	F95	● ICCILHOL30 US1	
		● ICSCCILHOL30 US1	
Double Locking, Entrance Lever	F97	CILVEN00 US1	
		CILVEN30 US1	
Single Locking, Passage Lever	F95	● ICCILVEN30 US1	
		● ICSCCILVEN30 US1	

T300 Series List Price

**COMMERCIAL / RESIDENTIAL HEAVY DUTY DEADBOLTS
ANSI STANDARD A156.36, GRADE 2**

- Optional Interchangeable Core for **Best, Falcon and Arrow**
- Optional Interchangeable Core for **Schlage Full Size Large Format**
- Optional Conversion Kit for up to 2 1/4" Thick Doors

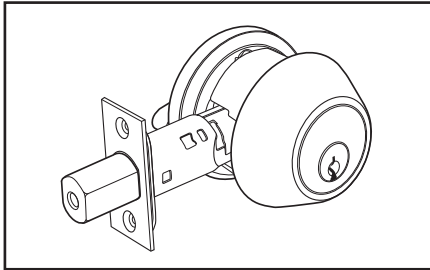

FUNCTION	ANSI	ITEM #	PCS / MC
Heavy Duty Single Cylinder Deadbolt, UL Listed	E0152	ULT360 US1	20

SQ300 Series List Price

**COMMERCIAL / RESIDENTIAL CONTEMPORARY SQUARE
HEAVY DUTY DEADBOLTS, ANSI STANDARD A156.36, GRADE 2**

- Optional Interchangeable Core for **Best, Falcon and Arrow**
- Optional Interchangeable Core for **Schlage Full Size Large Format**

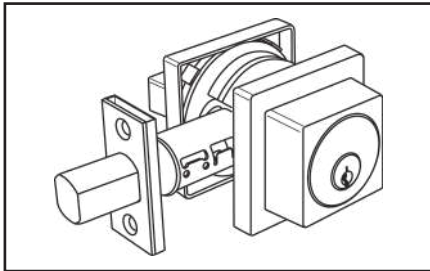

FUNCTION	ANSI	ITEM #	PCS / MC
Heavy Duty Single Cylinder Deadbolt, UL Listed	E0152	SQ-220 US1	20

T220 & T330 Series List Price

**COMMERCIAL / RESIDENTIAL STANDARD DUTY DEADBOLTS,
ANSI STANDARD A156.36, GRADE 3**

- Optional Interchangeable Core for **Best, Falcon and Arrow**
- Optional Interchangeable Core for **Schlage Full Size Large Format**

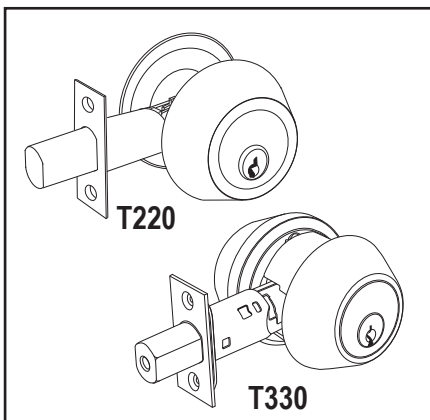

FUNCTION	ANSI	ITEM #	PCS / MC
Standard Duty Single Cylinder Deadbolt	E0153	T220 US1	20
Standard Duty Double Cylinder Deadbolt	E0143	T330 US1	

IND90-G2 Indicator Deadbolts

COMMERCIAL INDICATOR DEADBOLTS,
ANSI A156.36, GRADE 2

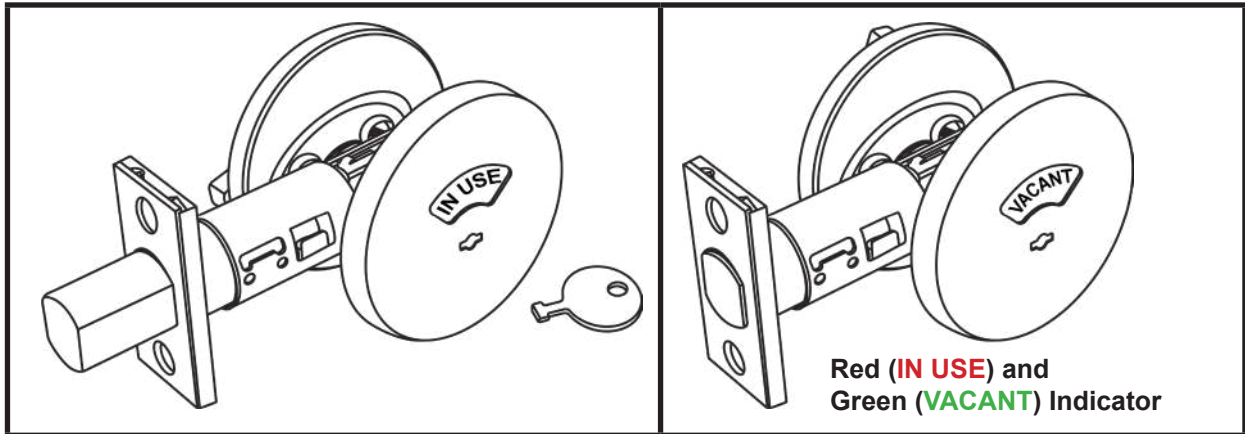

ITEM #	DESCRIPTION	PCS / MC
IND90-G2 US1	Indicator Deadbolt	20

INDLEV-20 Series List Price

COMMERCIAL GRADE PRIVACY INDICATOR LEVERSET

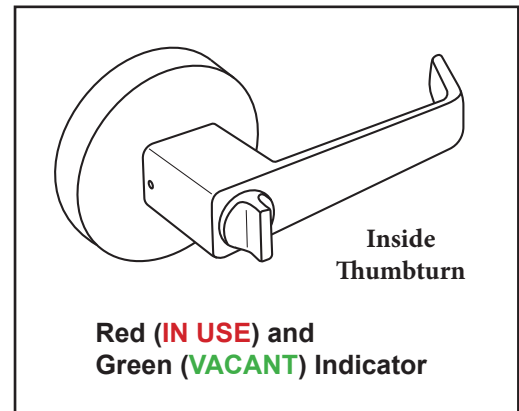
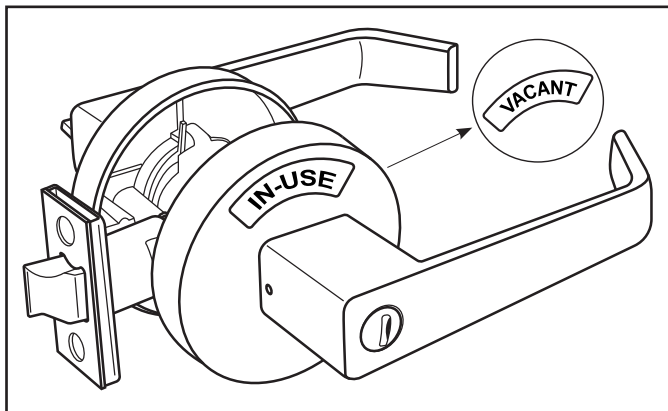

ITEM #	DESCRIPTION	PCS / MC
INDLEV-20 US1	Privacy Indicator Deadbolt	20

CHELSIE Series List Price







ANSI STANDARD A156.2 RESIDENTIAL LEVERSETS & ANSI STANDARD A156.36 DEADBOLTS, GRADE 3

- ▶ **KEYWAYS** (STD, "KW" 5-PIN KWIKSET) OPTIONAL 5-PIN SCHLAGE "C" & WEISER
 - All locksets, handle sets and deadbolts are available with **Schlage "C"** and **Weiser** keyway on special factory order only with no additional charge. Consult factory.
 - **SCHLAGE "C" KEYWAY OPTION:** For immediate stock shipment add **\$3.70 List** for keyed entrance lock and single cylinder deadbolts. Prefix C before Part # (Ex: REN00 with C keyway is CREN000)
 - **WEISER KEYWAY OPTION:** For keyed knob and leversets add **\$2.35 List**.
For Single Cylinder Deadbolts, add **\$3.50 List** and for Double Cylinder Deadbolts add **\$6.95 List**. Prefix "W" before Part # (Ex: REN00 with Weiser keyway is WREN00)

QUANTITY DISCOUNT

300 UNITS MIXED
- LESS 5%

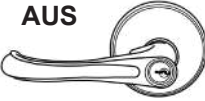
600 UNITS MIXED
- LESS 10%

MAY 	SOP  COMING SOON	LEN 	BRI 	AUS 	KOB  NEW ITEM
MAYFAIR	SOPHIA	LENOX	BRISTOL	AUSTIN	KOBE

Prefix "UL" before Part # when ordering UL Listed, available on Entrance and Passage functions. Add \$3.15 List.

FUNCTIONS	ANSI	ITEM #					PCS / MC
Entry - KA / 3	F109	*MAY-00	SOP-00	BRI-00	AUS-00	KOB-00	24
Storeroom - KA / 3	F86	*MAY-05	SOP-05	BRI-05	AUS-05	KOB-05	
Privacy	F76	*MAY-20	SOP-20	BRI-20	AUS-20	KOB-20	
Passage	F75	*MAY-30	SOP-30	BRI-30	AUS-30	KOB-30	
Active Dummy	----	*MAY-40	SOP-40	BRI-40	AUS-40	KOB-40	36

*Specify Handing

FUNCTIONS	ANSI	ITEM #	PCS / MC
Entry - KA / 3	F109	LEN-00	24
Storeroom - KA / 3	F86	LEN-05	
Privacy	F76	LEN-20	
Passage	F75	LEN-30	
Active Dummy	----	LEN-40	36

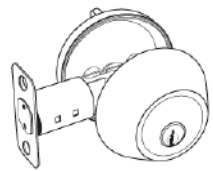
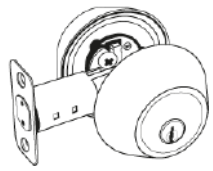
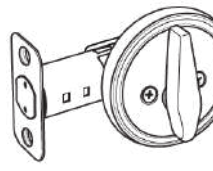
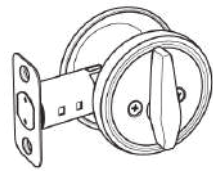
			
ED-500	EDD-400	ID-701	ID-801

FUNCTIONS	ITEM #	PCS / MC
Single cylinder deadbolt	ED-500 US1	36
Single cylinder deadbolt	ULED-500 US1	
Double cylinder deadbolt	EDD-400 US1	
One sided deadbolt	ID-701 US1	
One sided deadbolt with exterior cover plate	ID-801 US1	

HERITAGE Series List Price

RESIDENTIAL LEVERS ANSI STANDARD A156.2, GRADE 3

- ▶ **KEYWAYS** (STD, " KW " 5-PIN KWIKSET) OPTIONAL 5-PIN SCHLAGE "C" & WEISER
 - All locksets are available with **Schlage "C"** and **Weiser** keyway on special factory order only, with no additional charge. Consult factory.
 - **SCHLAGE "C" KEYWAY OPTION:** For immediate stock shipment, add **\$3.70 List** for keyed entrance lock.
Prefix "C" before Part # (Ex: AZU-00 with C keyway is CAZU-00)
 - **WEISER KEYWAY OPTION:** For keyed leversets, add **\$2.35 List**.
Prefix "W" before Part # (Ex: AZU-00 with Weiser keyway is WAZU-00)

Prefix "UL" before Part # when ordering UL Listed, available on Entrance and Passage functions.
Add \$3.15 List.

STOCK ITEMS IN BOLD.
 NON-STOCK FINISHES AND DESIGNS
 AVAILABLE WITH FACTORY LEAD TIME
 AND SUBJECT TO MINIMUM ORDER

QUANTITY DISCOUNT
300 UNITS MIXED - LESS 5%
600 UNITS MIXED - LESS 10%

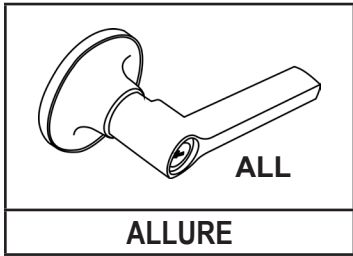

FUNCTIONS	ANSI	ITEM #	PCS / MC
Entry - KA / 3	F109	ALL-00 US1	24
Storeroom - KA / 3	F86	ALL-05 US1	
Privacy	F76	ALL-20 US1	
Passage	F75	ALL-30 US1	
Active Dummy	----	ALL-40 US1	36

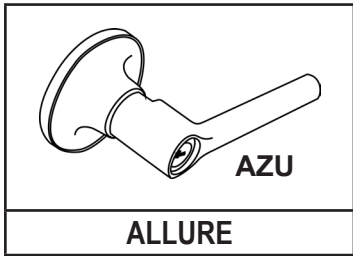

FUNCTIONS	ANSI	ITEM #	PCS / MC
Entry - KA / 3	F109	AZU-00 US1	24
Storeroom - KA / 3	F86	AZU-05 US1	
Privacy	F76	AZU-20 US1	
Passage	F75	AZU-30 US1	
Active Dummy	----	AZU-40 US1	36

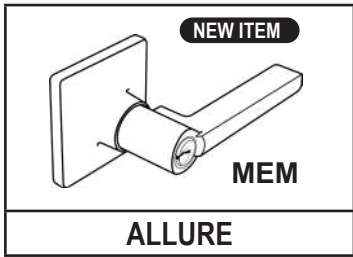

FUNCTIONS	ANSI	ITEM #	PCS / MC
Entry - KA / 3	F109	MEM-00 US1	24
Storeroom - KA / 3	F86	MEM-05 US1	
Privacy	F76	MEM-20 US1	
Passage	F75	MEM-30 US1	
Active Dummy	----	MEM-40 US1	36

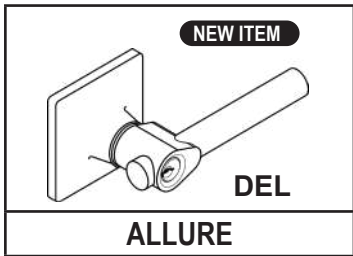

FUNCTIONS	ANSI	ITEM #	PCS / MC
Entry - KA / 3	F109	DEL-00 US1	24
Storeroom - KA / 3	F86	DEL-05 US1	
Privacy	F76	DEL-20 US1	
Passage	F75	DEL-30 US1	
Active Dummy	----	DEL-40 US1	36

CONTEMPORARY Series List Price

ANSI STANDARD A156.2 RESIDENTIAL LEVERS & A156.36 DEADBOLTS, GRADE 3

STOCK ITEMS IN BOLD.
NON-STOCK FINISHES AND DESIGNS
AVAILABLE WITH FACTORY LEAD TIME
AND SUBJECT TO MINIMUM ORDER

QUANTITY DISCOUNT
300 UNITS MIXED - LESS 5%
600 UNITS MIXED - LESS 10%

HOLLAND ----- HOL DESIGN

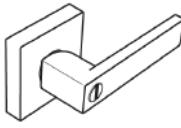
	FUNCTIONS		ANSI	ITEM #	PCS / MC
	Entry - KA / 3	*NH	F109	HOL-00 US1	18
	Privacy	*NH	F76	HOL-20 US1	20
	Passage	*NH	F75	HOL-30 US1	
	Dummy	*NH	----	HOL-40 US1	36

* NH is for Non-Handed (Reversible) **NOT AVAILABLE WITH UL LATCH** ☒

ATLAS ----- ATL DESIGN

	FUNCTIONS		ANSI	ITEM #	PCS / MC
	Privacy	*H	F76	ATL20 US1	20
	Passage	*NH	F75	ATL30 US1	
	Dummy	*NH	----	ATL40 US1	36

* NH is for Non-Handed (Reversible) * H is for Handed (Order Handing for Convenience) **NOT AVAILABLE WITH UL LATCH** ☒

JUPITER ----- JUP DESIGN

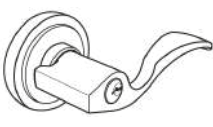
	FUNCTIONS		ANSI	ITEM #	PCS / MC
	Entry - KA / 3	*H	F109	JUP-00 US1	18
	Privacy	*H	F76	JUP-20 US1	20
	Passage	*H	F75	JUP-30 US1	
	Dummy	*H	----	JUP-40 US1	36

* H is for Handed (Order Handing for Convenience) **NOT AVAILABLE WITH UL LATCH** ☒

PHOENIX ----- PHO DESIGN

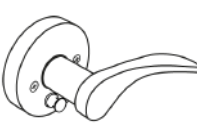
	FUNCTIONS		ANSI	ITEM #	PCS / MC
	Entry - KA / 3	*H	F109	PHO-00 US1	18
	Privacy	*H	F76	PHO-20 US1	20
	Passage	*H	F75	PHO-30 US1	
	Dummy	*H	----	PHO-40 US1	36

* H is for Handed (Order Handing for Convenience) **NOT AVAILABLE WITH UL LATCH** ☒

VANITY ----- VAN DESIGN

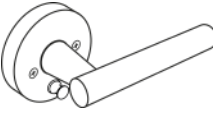
	FUNCTIONS		ANSI	ITEM #	PCS / MC
	Privacy	*H	F76	VAN-20 US1	20
	Passage	*NH	F75	VAN-30 US1	
	Dummy	*NH	----	VAN-40 US1	36

* NH is for Non-Handed (Reversible) * H is for Handed (Order Handing for Convenience) **NOT AVAILABLE WITH UL LATCH** ☒

ESQUIRE ----- ESQ DESIGN

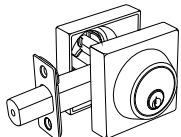
	FUNCTIONS		ANSI	ITEM #	PCS / MC
	Square Single Cylinder Deadbolt	*NH		ESQ-101 US1	36
	Square Double Cylinder Deadbolt	*NH		ESQ-102 US1	

* NH is for Non-Handed (Reversible) **NOT AVAILABLE WITH UL LATCH** ☒

SUMMIT Series List Price

WITH PUSH BUTTON LOCKING MECHANISM
AND AUTO RELEASE FEATURE, ANSI STANDARD A156.2, GRADE 3

ALL DESIGNS HAVE PUSH BUTTON LOCKING MECHANISM & AUTO RELEASE FOR IMMEDIATE EGRESS, PANIC EXIT STRUCTURE ON PRIVACY FUNCTIONS. KEYED ENTRY FOR AMBER DESIGN ONLY.



STOCK ITEMS IN BOLD.
NON-STOCK FINISHES AND DESIGNS
AVAILABLE WITH FACTORY LEAD TIME
AND SUBJECT TO MINIMUM ORDER

QUANTITY DISCOUNT
300 UNITS MIXED - LESS 5%
600 UNITS MIXED - LESS 10%

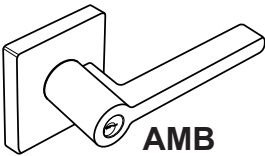
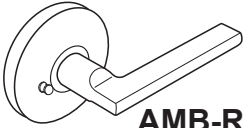
AMBER ----- AMB SERIES

 AMB CONCEALED SCREW  AMB-R	FUNCTIONS		ANSI	ITEM #	PCS / MC
	Entrance	*NH	---	AMB-00 US1	20
	Privacy	*NH	F76	**AMB-20 US1	
	Passage	*NH	F75	**AMB-30 US1	
	Dummy	*NH	---	**AMB-40 US1	36
<p>Comes standard with Square Rose. Add Suffix "R" after Part # for Round Rose option. **Round Rose option is only available in AMB-20, AMB-30, and AMB-40. For Example: To order AMB-20 US15 with Round Rose, use "AMB-20R US15" when ordering. * NH is for Non-Handed NOT AVAILABLE WITH UL LATCH ☒</p>					

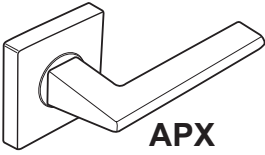
APEX ----- APX SERIES

 APX CONCEALED SCREW  APX-R	FUNCTIONS		ANSI	ITEM #	PCS / MC
	Privacy	*NH	F76	APX-20 US1	20
	Passage	*NH	F75	APX-30 US1	
	Dummy	*NH	---	APX-40 US1	36
<p>Comes standard with Square Rose. Add Suffix "R" after Part # for Round Rose option. For Example: To order APX-20 US15 with Round Rose, use "APX-20R US15" when ordering. * NH is for Non-Handed NOT AVAILABLE WITH UL LATCH ☒</p>					

ARGO ----- ARG SERIES

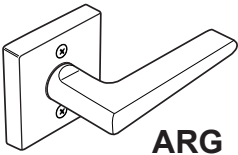
 ARG EXPOSED SCREW	FUNCTIONS		ANSI	ITEM #	PCS / MC
	Privacy	*NH	F76	ARG-20 US1	20
	Passage	*NH	F75	ARG-30 US1	
	Dummy	*NH	---	ARG-40 US1	36
<p>Comes standard with Square Rose. * NH is for Non-Handed NOT AVAILABLE WITH UL LATCH ☒</p>					

LEGACY Series List Price

RESIDENTIAL LEVERS A156.2, GRADE 3

► **KEYWAYS (STD, "KW" 5-PIN KWIKSET) OPTIONAL 5-PIN SCHLAGE "C" & WEISER**

- All locksets are available with **Schlage "C"** and **Weiser** keyway on special factory order with no additional charge, or from stock with additional charges. See below.
- **SCHLAGE "C" KEYWAY OPTION:** For immediate stock shipment **add \$3.95 List** for keyed locks.
Prefix "C" before Part # (Ex: ZUL00 with C keyway is CZUL00)
- **WEISER KEYWAY OPTION:** For immediate stock shipment **add \$3.95 List** for keyed locks
Prefix "W" before Part # (Ex: ZUL00 with Weiser keyway is WZUL00)

Prefix "UL" before Part # when ordering UL Listed, available on Entrance, Storeroom, Privacy, Passage functions. **Add \$4.65 to List**

ALL ITEMS BELOW AVAILABLE WITH FACTORY LEAD TIME AND SUBJECT TO MINIMUM ORDER QUANTITY



DUCATI DESIGN 	FUNCTIONS		ANSI	ITEM #	US1	PCS / MC
	Entrance w/ Push Button		F109	DUC00	\$42.05	24
	Storeroom		F86	DUC05		24
	Privacy w/ Push Button		F76	DUC20	35.20	24
	Passage		F75	DUC30	32.10	24
	Dummy		--	DUC40	14.10	24

DENMARK DESIGN 	FUNCTIONS		ANSI	ITEM #	US1	PCS / MC
	Entrance w/ Push Button		F109	DEN00	\$45.80	24
	Storeroom		F86	DEN05		24
	Privacy w/ Push Button		F76	DEN20	37.45	24
	Passage		F75	DEN30	34.30	24
	Dummy		--	DEN40	15.15	24

QUANTITY DISCOUNT

300 UNITS MIXED - LESS 5%

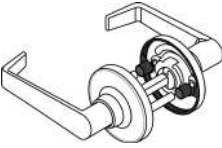
600 UNITS MIXED - LESS 10%

CABERNET DESIGN 	ZULATTI DESIGN 	FUNCTIONS		ANSI	ITEM #		US1	PCS / MC
		Entrance w/ Push Button		F109	CAB00	ZUL00	\$39.95	24
		Storeroom		F86	CAB05	ZUL05		24
		Privacy w/ Push Button		F76	CAB20	ZUL20	39.25	24
		Passage		F75	CAB30	ZUL30	38.70	24
		Dummy		--	CAB40	ZUL40	17.15	24

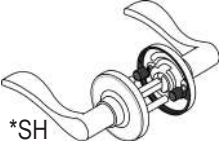
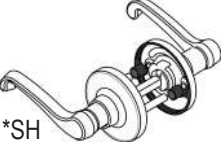
NAPA DESIGN 	VIARGENTO DESIGN 	FUNCTIONS		ANSI	ITEM #		US1	PCS / MC
		Entrance w/ Push Button		F109	NAP00	VIA00	\$45.80	24
		Storeroom		F86	NAP05	VIA05		24
		Privacy w/ Push Button		F76	NAP20	VIA20	37.45	24
		Passage		F75	NAP30	VIA30	34.30	24
		Dummy		--	NAP40	VIA40	15.60	24

*SH is for Specify Handing

CLIPPER Series List Price

RESIDENTIAL DEADBOLTS A156.36, GRADE 3

► **KEYWAYS (STD, "KW" 5-PIN KWIKSET) OPTIONAL 5-PIN SCHLAGE "C" & WEISER**

- All deadbolts are available with **Schlage "C"** and **Weiser** keyway on special factory order with no additional charge, or from stock with additional charges. See below.
- **SCHLAGE "C" KEYWAY OPTION:** For immediate stock shipment **add \$3.95 List** for single and double cylinder deadbolts. Prefix "C" before Part # (Ex: CLP500 with C keyway is CCLP500)
- **WEISER KEYWAY OPTION:** For immediate stock shipment **add \$3.95 List** for single and double cylinder deadbolts. Prefix "W" before Part # (Ex: CLP500 with Weiser keyway is WCLP500)

Prefix "UL" before Part # when ordering UL Listed. Add \$5.20 to List.

ALL ITEMS BELOW AVAILABLE WITH FACTORY LEAD TIME AND SUBJECT TO MINIMUM ORDER QUANTITY

	FUNCTIONS	ITEM #	PCS / MC
	Single Cylinder Deadbolt	CLP500 US1	24
	Double Cylinder Deadbolt	CLP400 US1	24
	One Sided Deadbolt with Cover	CLP801 US1	24
	One Sided Deadbolt	CLP701 US1	24

QUANTITY DISCOUNT

300 UNITS MIXED - LESS 5%

600 UNITS MIXED - LESS 10%

ITALIA Series List Price

STAINLESS STEEL LOCKSETS, KNOBSETS, ESCUTCHEONS, ANSI STANDARD A156.2, GRADE 3
OPTIONAL GRADE 2

ALL ITEMS BELOW AVAILABLE WITH FACTORY LEAD TIME AND SUBJECT TO MINIMUM ORDER QUANTITY

HOW TO ORDER					
DDD-FFB-[H]R US1					
DESIGN (ddd)	FUNCTION (FF)	BACKSET (b)	HANDING (H)	ROSE (R)	FINISH (US1)
See Lever / Knob designs in the table below	00 - Entrance 20 - Privacy 30 - Passage 40 - Single Dummy	8 - 2 3/8" (standard) 4 - 2 3/4" 2 - Gr. 2 (Passage) 2H - Gr 2 (L/R - Privacy) 2V - Gr. 2 (RHR/LHR -Privacy)	L - Left Hand R - Right Hand SPECIFY for Handed Levers or Scudo Privacy	G - Giro Q - Quadro S - Scudo	US1 - Black

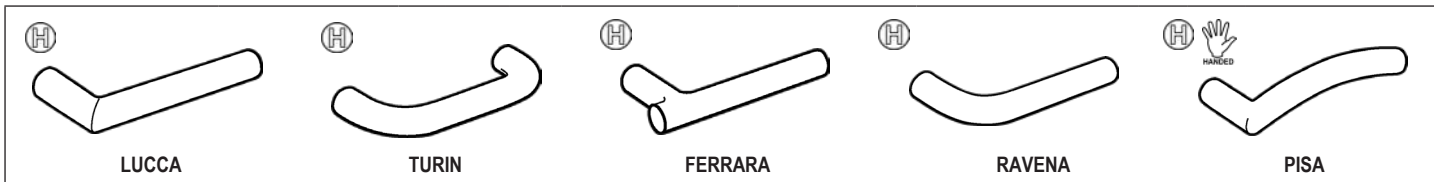
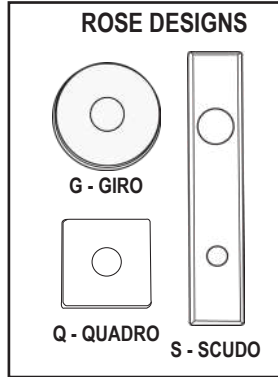

LEVER DESIGNS	FUNCTION + 2 3/8" BACKSET STD			HANDING	ROSE DESIGN			PCS/MC		UPGRADE TO GRADE 2
					G (ROUND)	Q (SQUARE)	S (ESCUTCHEON)	Q	S	
					US1	US1	US1	G	S	
LUCCA - LUC TURIN - TUR FERRARA - FER RAVENA - RAV *PISA - PIS	ENTRANCE w/ deadbolt	00	8	L / R *Handed			\$154.00			ADD \$14.00
	PRIVACY	20	8		\$74.00	\$82.00	**134.00	24	6	
	PASSAGE	30	8		74.00	82.00	134.00			
	DUMMY (SINGLE)	40			40.00	44.00	67.00	36		

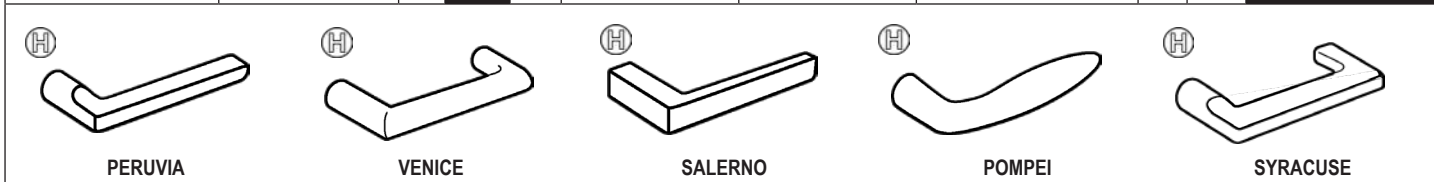

LEVER DESIGNS	FUNCTION + 2 3/8" BACKSET STD			HANDING	ROSE DESIGN			PCS/MC		UPGRADE TO GRADE 2
					G (ROUND)	Q (SQUARE)	S (ESCUTCHEON)	Q	S	
					US1	US1	US1	G	S	
PERUVIA - PER VENICE - VEN SALERNO - SAL POMPEI - POM SYRACUSE - SYR	ENTRANCE w/ deadbolt	00	8	Non-handed			\$154.00			ADD \$14.00
	PRIVACY	20	8		\$85.00	\$94.00	**134.00	24	6	
	PASSAGE	30	8		85.00	94.00	134.00			
	DUMMY (SINGLE)	40			43.00	47.00	67.00	36		

- HANDED - HOLLOW - SOLID

◆◆ CONTINUED NEXT PAGE ◆◆

****Specify Handing when ordering Privacy function with Scudo rose design**

QUANTITY DISCOUNT
300 UNITS MIXED - LESS 5%
600 UNITS MIXED - LESS 10%

ITALIA Series List Price

STAINLESS STEEL LOCKSETS, KNOBSETS, ESCUTCHEONS, ANSI STANDARD A156.2, GRADE 3, OPTIONAL GRADE 2

ALL ITEMS BELOW AVAILABLE WITH FACTORY LEAD TIME AND SUBJECT TO MINIMUM ORDER QUANTITY

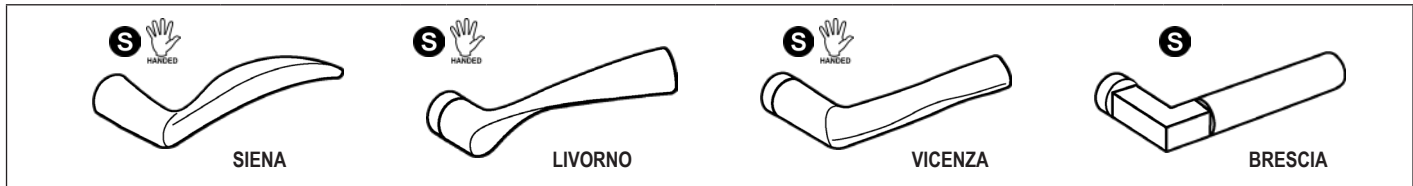
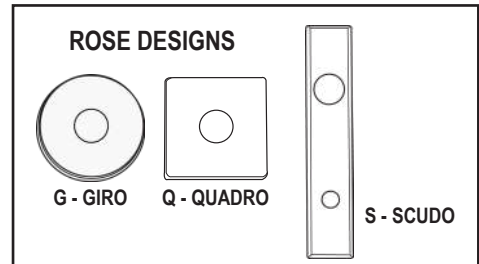

SOLID LEVER DESIGNS	FUNCTION + 2 3/8" BACKSET STD			HANDING	ROSE DESIGN			PCS/MC		UPGRADE TO GRADE 2
					G (ROUND) US1	Q (SQUARE) US1	S (ESCUTCHEON) US1	Q G	S	
*SIENA - SIE *LIVORNO - LIV *VICENZA - VIC BRESCIA - BRE	ENTRANCE w/ deadbolt	00	8	L / R*Handed						ADD \$14.00
	PRIVACY	20	8		\$96.00	\$105.00	**147.00	24	6	
	PASSAGE	30	8		96.00	105.00	147.00			
	DUMMY (SINGLE)	40			47.00	52.00	73.50	36		

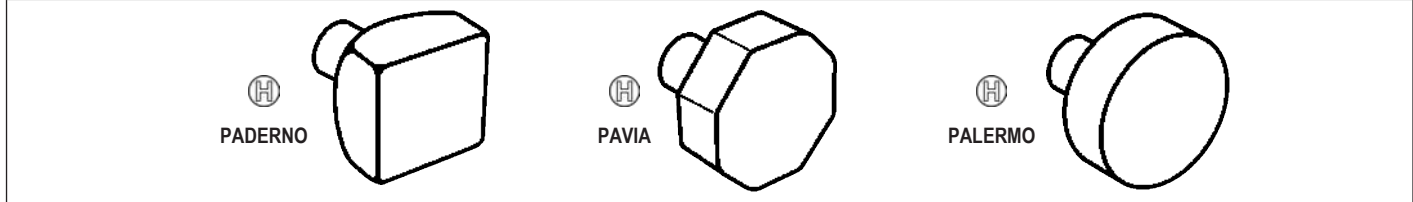

KNOB DESIGNS	FUNCTION + 2 3/8" BACKSET STD			HANDING	ROSE DESIGN			PCS/MC		UPGRADE TO GRADE 2
					G (ROUND) US1	Q (SQUARE) US1	S (ESCUTCHEON) US1	Q G	S	
PADERNO - PAD PALERMO - PAL PAVIA - PAV	ENTRANCE w/ deadbolt	00	8	Non-handed						ADD \$14.00
	PRIVACY	20	8		\$103.00	\$113.00	**162.00	24	6	
	PASSAGE	30	8		103.00	113.00	162.00			
	DUMMY (SINGLE)	40			52.00	57.00	81.00	36		

► OPTIONS

- Optional 2 3/8" backset and 4-way, Adjustable Grade 2 Drive-in latch bolt
- See PARTS and ACCESSORIES page for options.



QUANTITY DISCOUNT
300 UNITS MIXED - LESS 5%
600 UNITS MIXED - LESS 10%

****Specify Handing when ordering
 Privacy function with Scudo rose design**

ITALIA Series List Price

STAINLESS STEEL MORTISE LOCKS ANSI A156.13, GRADE 1 & DEADBOLTS WITH GRADE 1 LATCH ANSI A156.36, GRADE 3

QUANTITY DISCOUNT

300 UNITS MIXED - LESS 5%

600 UNITS MIXED - LESS 10%

ALL ITEMS BELOW AVAILABLE WITH FACTORY LEAD TIME AND SUBJECT TO MINIMUM ORDER QUANTITY

► MORTISE LOCK FUNCTIONS

FUNCTIONS		ANSI	US19	PCS / MC
Single cylinder without deadbolt	NM8050 - Office / Entrance	F04	\$327.15	6
	NM8070 - Classroom	F05		
	NM8080 - Storeroom	F07		
Single cylinder with deadbolt	NM8453 - Entrance	F20	336.65	6
	NM8456 - Corridor	F13		
	NM8495 - Keyed Privacy with Indicator	----	381.10	
	NM8465 - Closet / Storeroom with Deadbolt	----	336.35	
	NM8473 - Dormitory / Bedroom	F21		
Double cylinder without deadbolt	NM8082 - Asylum / Institution	F30	347.95	6
Double cylinder with deadbolt	NM8466 - Storeroom	F14	347.95	6
Other functions	NM8440 - Privacy with Deadbolt	F19	315.50	6
	NM8445 - Privacy with Deadbolt, Coin Turn & Indicator	F19B	397.25	
	NM8010 - Passage	F01	281.75	

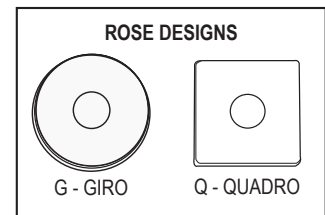

TO ORDER:

- refer to functions in the NM Series page and choose a function,
- indicate handing,
- lever / knob design,
- rose design (G or Q) and finish:

NMnnnnHH-ddd-r US32x

e.g. : To order NM8080 function LH in SIENA lever design with round rose in US32D finish use:

NM8080LH-SIE-G US32D

●● All keyed lock functions are available with Best, Falcon and Arrow, Schlage, Corbin / Russwin, Sargent, and Yale Large Format Interchangeable Cores. Prices do not include cores.

► KEYWAY standard 5-PIN SCHLAGE "C"

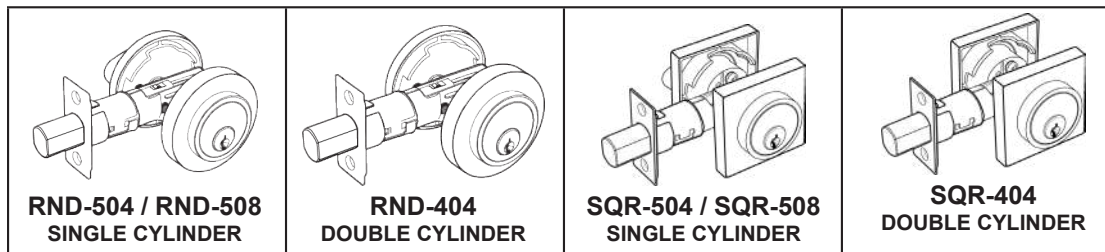

FUNCTIONS	ANSI	ITEM #	US1	PCS / MC
Single Cylinder Round Deadbolt for 1 3/4" Door Thickness	E0153	RND-504	\$56.00	18
Single Cylinder Round Deadbolt for 1 3/8" Door Thickness	E0153	RND-508	56.00	
Single Cylinder Square Deadbolt for 1 3/4" Door Thickness	E0153	SQR-504	56.00	
Single Cylinder Square Deadbolt for 1 3/8" Door Thickness	E0153	SQR-508	56.00	
Double Cylinder Round Deadbolt for 1 3/4" Door Thickness	E0143	RND-404	64.00	
Double Cylinder Square Deadbolt for 1 3/4" Door Thickness	E0143	SQR-404	64.00	

HINGES

ILLUSTRATION	ITEM #	DESCRIPTION
	STANDARD WEIGHT, BALL BEARING HINGES Full Mortise, Two Ball Bearings (Template)	
	BB31 US1	4 1/2" x 4 1/2"
	BB31 US1NRP	
	BB454 US1	4 1/2" x 4"
	BB454 US1BLKNRP	
	BB55 US1BLACK	5" x 5"
	BBSC56 US1	4" x 4"
BBRC45 US1	4" x 4" (1/4" Radius)	
	STANDARD WEIGHT, Full Mortise, Plain Bearing (Template)	
	TBHSC55 US1	4" x 4"
	TBHRC44 US1	4" x 4" (1/4" Radius)
	TBHSC77 US1	3 1/2" x 3 1/2"
	TBHRC66 US1	3 1/2" x 3 1/2" (1/4" Radius)
	SPRING HINGES Full Mortise, Standard Weight, Single Acting Spring Hinges (Template)	
	NEWSH140 US1	4 1/2" x 4 1/2"
	NEWSH44R US1	4" x 4" (1/4" Radius)
	NEWSH35R US1	3 1/2" X 3 1/2" (1/4" Radius)
	NEWSH3558R US1	3 1/2" X 3 1/2" (5/8" Radius)
	Full Mortise, Standard Weight, Spring Hinges (Non Template)	
NEWSH4458R US1	4" x 4" (5/8" Radius)	
RESIDENTIAL HINGES Full Mortise, Residential Weight, Plain Bearing 5 Knuckles		
	RH35 US1	3 1/2" X 3 1/2" (5/8" Radius) Template
	10RH35 US1	3 1/2" X 3 1/2" (5/8" Radius) Template with 1" screws
	RH61 US1	3 1/2" X 3 1/2" (1/4" Radius) Template
	RH40 US1	4" x 4" (5/8" Radius) Non Template
	RH40 US1NRP	
	RH60 US1	4" x 4" (1/4" Radius) Non Template
RH60 US1NRP		
TIMELY, REDDI FRAME HINGES Full Mortise, Residential Weight, Plain Bearing (Template)		
	TBHRC33 US1DBLK	4" x 4" (1/4" Radius)
	TBHRC45 US1BLK	3 1/2" X 3 1/2" (1/4" Radius)

HINGES

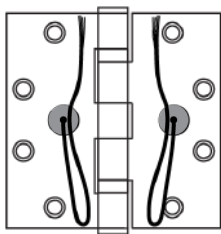
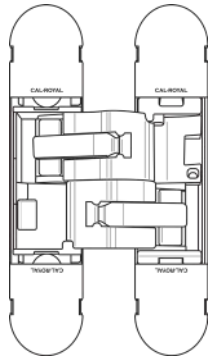
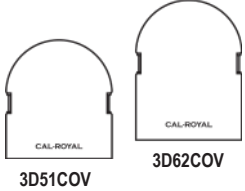
ILLUSTRATION	ITEM #	DESCRIPTION
	ELECTRIFIED HINGES <i>Full Mortise, Residential Weight, 2-Ball Bearing (Template)</i>	
	ELE4BB31 US1 <div style="background-color: black; color: white; padding: 2px; display: inline-block; margin-top: 5px;">NEW ITEM</div>	4 1/2" x 4 1/2"
	3D INVISIBLE HINGES	
	CR3D62 US1	6 5/16" x 1 1/4"
	CR3D51 US1	5 1/8" x 1 3/16"
 <div style="display: flex; justify-content: space-around; margin-top: 5px;"> 3D51COV 3D62COV </div>	3D HINGE ACCESSORIES	
	3D62COV US1	Extra Covers for CR3D62 hinge
	3D51COV US1	Extra Covers for CR3D51 hinge

EXIT DEVICES

ILLUSTRATION	ITEM #	DESCRIPTION
<p><i>*SH Specify: Left Hand Reverse (LHR) or Right Hand Reverse (RHR) for convenience on SVR Only.</i></p> <div style="border: 1px solid black; padding: 5px; width: fit-content;"> <p>QUANTITY DISCOUNT 16 UNITS MIXED - LESS 5% 32 UNITS MIXED - LESS 10%</p> </div>	NON-FIRE EXIT HARDWARE	
	A7700EO36 L1	Rim exit, 36"
	A7720EO48 L1	Rim exit, 48"
	A7760V3684 L1	Surface vertical rod 36" X 84" *SH
	A7790V3696 L1	Surface vertical rod 36" X 96" *SH
	A7750V36120 L1	Surface vertical rod 36" X 120" *SH
	A7780V4896 L1	Surface vertical rod 48" X 96" *SH
	A7740V48120 L1	Surface vertical rod 48" X 120" *SH
	FIRE EXIT HARDWARE RATED 3 HOURS (Includes thru-bolts)	
	AF7700EO36 L1	Rim exit, 36"
	AF7720EO48 L1	Rim exit, 48"
	AF7760V3684 L1	Surface vertical rod 36" X 84" *SH
	AF7790V3696 L1	Surface vertical rod 36" X 96" *SH
	AF7780V4896 L1	Surface vertical rod 48" X 96" *SH
AF7750V36120 L1	Surface vertical rod 36" X 120" *SH	
AF7740V48120 L1	Surface vertical rod 48" X 120" *SH	
ROSE TRIMS (NON-HANDED)		
	ENT00L US1 ICENT00L US1 ICSCENT00L4 US1	Clutch Entrance
<div style="border: 1px solid black; border-radius: 15px; padding: 10px; text-align: center;"> <p><i>For Other Designs: Prefix "AT", "RL", "TUB", "LON" or "TAC" before "ESC77" when ordering. e.g. ESC7700 with "TAC" design, will be "TACESC7700" LIST PRICE @ \$170.60</i></p> </div>	STR05L US1 ICSTR05L US1 ICSCSTR05L4 US1	Clutch Storeroom
	PAS30L US1	Passage
	DUM40L US1	Dummy Trim
	ESCUTCHEON TRIMS (NON-HANDED)	
	ESC7700 US1 ICESC7700 US1 ICSCESC7700 US1	Rigid Entrance
	ESC7705 US1 ICESC7705 US1 ICSCESC7705 US1	Rigid Storeroom
	ESC7730 US1	Passage
	ESC7740 US1	Dummy Trim
ELECTRIFIED ESCUTCHEON TRIMS (NON-HANDED)		
<div style="border: 1px solid black; border-radius: 15px; padding: 10px; text-align: center;"> <p><i>For Other Designs: Prefix "AT", "RL", "TUB", "LON" or "TAC" before "ESC77" when ordering. e.g. FS12ESC77 with "TAC" design, will be "FS12TACESC77"</i></p> </div>	FS12ESC77 US1 ICFS12ESC77 US1 ICSCFS12ESC77 US1	FAIL-SAFE (FS) OPTION 12V AC / DC
	FS24ESC77 US1 ICFS24ESC77 US1 ICSCFS24ESC77 US1	FAIL-SAFE (FS) OPTION 24V AC / DC
	FSE12ESC77 US1 ICFSE12ESC77 US1 ICSCFSE12ESC77 US1	FAIL-SECURE (FSE) OPTION 12V AC / DC
	FSE24ESC77 US1 ICFSE24ESC77 US1 ICSCFSE24ESC77 US1	FAIL-SECURE (FSE) OPTION 24V AC / DC

● (IC) Indicates function available with Best, Falcon & Arrow Interchangeable Core.

●● (ICSC) Indicates function available with Schlage Full Size Format Interchangeable Core.

EXIT DEVICES

ILLUSTRATION	ITEM #	DESCRIPTION
<p><i>*SH Specify: Left Hand Reverse (LHR) or Right Hand Reverse (RHR) for convenience on SVR Only.</i></p> <div style="border: 1px solid black; padding: 5px; width: fit-content; margin: 10px auto;"> <p>QUANTITY DISCOUNT 16 UNITS MIXED - LESS 5% 32 UNITS MIXED - LESS 10%</p> </div>	NON-FIRE EXIT HARDWARE	
	A9800EO36 L1	Rim exit, 36"
	A9820EO48 L1	Rim exit, 48"
	A9860V3684 L1	Surface vertical rod 36" X 84" *SH
	A9890V3696 L1	Surface vertical rod 36" X 96" *SH
	A9850V36120 L1	Surface vertical rod 36" X 120" *SH
	A9880V4896 L1	Surface vertical rod 48" X 96" *SH
	A9840V48120 L1	Surface vertical rod 48" X 120" *SH
	FIRE EXIT HARDWARE RATED 3 HOURS (Includes thru-bolts)	
	AF9800EO36 L1	Rim exit, 36"
	AF9820EO48 L1	Rim exit, 48"
	AF9860V3684 L1	Surface vertical rod 36" X 84" *SH
	AF9890V3696 L1	Surface vertical rod 36" X 96" *SH
	AF9880V4896 L1	Surface vertical rod 48" X 96" *SH
	AF9850V36120 L1	Surface vertical rod 36" X 120" *SH
AF9840V48120 L1	Surface vertical rod 48" X 120" *SH	
ROSE TRIMS (NON-HANDED)		
<div style="border: 1px solid black; padding: 5px; width: fit-content; margin: 10px auto;"> <p><i>For Other Designs: Prefix "AT", "RL", "TUB", "LON" or "TAC" before "ESC77" when ordering. e.g. NESC9800 with "TAC" design, will be "TACESC9800"</i></p> <p>LIST PRICE @ \$170.60</p> </div>	ENT00L US1	Clutch Entrance
	ICENT00L US1	
	ICSCENT00L4 US1	Clutch Storeroom
	STR05L US1	
	ICSTR05L US1	
	ICSCSTR05L4 US1	Passage
PAS30L US1	Dummy Trim	
DUM40L US1	ESCUTCHEON TRIMS (NON-HANDED)	
	NESC9800 US1	Rigid Entrance
	ICNESC9800 US1	
	ICSCNESC9800 US1	Rigid Storeroom
	NESC9805 US1	
	ICNESC9805 US1	
	ICSCNESC9805 US1	Passage
	NESC9830 US1	Dummy Trim
	NESC9840 US1	ELECTRIFIED ESCUTCHEON TRIMS (NON-HANDED)
<div style="border: 1px solid black; padding: 5px; width: fit-content; margin: 10px auto;"> <p><i>For Other Designs: Prefix "AT", "RL", "TUB", "LON" or "TAC" before "ESC98" when ordering. e.g. FS12NESC98 with "TAC" design, will be "FS12TACESC98"</i></p> </div>	FS12NESC98 US1	FAIL-SAFE (FS) OPTION 12V AC / DC
	ICFS12NESC98 US1	
	ICSCFS12NESC98 US1	
	FS24NESC98 US1	FAIL-SAFE (FS) OPTION 24V AC / DC
	ICFS24NESC98 US1	
	ICSCFS24NESC98 US1	
	FSE12NESC98 US1	FAIL-SECURE (FSE) OPTION 12V AC / DC
	ICFSE12NESC98 US1	
	ICSCFSE12NESC98 US1	
	FSE24NESC98 US1	FAIL-SECURE (FSE) OPTION 24V AC / DC
	ICFSE24NESC98 US1	
	ICSCFSE24NESC98 US1	

●● (IC) Indicates function available with Best, Falcon & Arrow Interchangeable Core.
 ●●● (ICSC) Indicates function available with Schlage Full Size Format Interchangeable Core.

EXIT DEVICES

ILLUSTRATION	ITEM #	DESCRIPTION
<div style="border: 1px solid black; padding: 5px; margin: 10px 0;"> <p>QUANTITY DISCOUNT 16 UNITS MIXED - LESS 5% 32 UNITS MIXED - LESS 10%</p> </div> <p><i>*SH Specify: Left Hand Reverse (LHR) or Right Hand Reverse (RHR) for convenience on SVR Only.</i></p>	NON-FIRE EXIT HARDWARE	
	A2200EO36 L1	Rim exit, 36"
	A2220EO48 L1	Rim exit, 48"
	A2260V3684 L1	Surface vertical rod 36" X 84" *SH
	A2280V4896 L1	Surface vertical rod 48" X 96" *SH
	FIRE EXIT HARDWARE RATED 3 HOURS (Includes thru-bolts)	
	AF2200EO36 L1	Rim exit, 36"
	AF2220EO48 L1	Rim exit, 48"
	AF2260V3684 L1	Surface vertical rod 36" X 84" *SH
	AF2280V4896 L1	Surface vertical rod 48" X 96" *SH
	ROSE TRIMS (NON-HANDED)	
	ENT00L US1 ICENT00L US1 ICSCENT00L4 US1	Clutch Entrance
	STR05L US1 ICSTR05L US1 ICSCSTR05L4 US1	Clutch Storeroom
	PAS30L US1	Passage
DUM40L US1	Dummy Trim	

BUILDERS HARDWARE

ILLUSTRATION	ITEM NO	DESCRIPTION
NUMBERS & LETTERS		
	PN20BK	4" Diecast House Numbers (0-9) and Letters (A-F) Packed with Nails. Affix number or letter to be ordered with Item code. e.g. "PN20BK 4" to order (4) in black finish. Thickness: 3/32"
	MDN5US1 NEW ITEM	5" Floating Modern Number (0-9) Zinc Alloy Material. Packed with screws for floating or flushed mount installations. Affix number to be ordered with item code. e.g. "MDN5US1 4" to order (4) in US1 finish. Thickness: 5/16"
MISCELLANEOUS DOOR AND WINDOW HARDWARE		
	SBCF222 US19	Solid Brass Window Casement Fasteners Size: 1 5/8" x 7/8", Projection 1 3/8"
	SBCF333 US19	Solid Brass Window Casement Fasteners Size: 2 1/16" x 1 1/16", Projection 1 7/8"
	ASAST US1	Template ASA Strike, Steel Base Size: 4 7/8" x 3 3/8" x 1 1/4"
	ARL-1338 019	Heavy Duty Roller Catch Adjustable Nylon Roller with Square Heavy Duty Cast 2 1/4" Full Lip Strike; Size: 1/8" x 1" x 3 3/8", Depth: 1 13/16" ANSI / BHMA:E09091
	ARLTSTRK62 US19	Optional T-Strike for Heavy Duty Roller Catch ARL1338 Size: 2 3/4" x 1 1/2" x 1 3/4"
KICK PLATES		
	ANO634 US1 NEW ITEM	Aluminum Kick Plate with Screws Size: 0.32" x 6" x 34"
	ANO834 US1 NEW ITEM	Aluminum Kick Plate with Screws Size: 0.32" x 8" x 34"
	ANO1034 US1 NEW ITEM	Aluminum Kick Plate with Screws Size: 0.32" x 10" x 34"

BUILDERS HARDWARE

ILLUSTRATION	ITEM NO	DESCRIPTION
PUSH / PULL PLATES		
	PSPL3515 US1BLK	Push Plate (Size: 0.050" x 3 1/2" x 15") Packed with Protective Film and Screws
	PSPL4016 US1BLACK	Push Plate (Size: 0.050" x 4" x 16") Packed with Protective Film and Screws ANSI / BHMA J301
	PULPL3515 US1BLK	Pull Plate (Size: 0.050" x 3 1/2" x 15") Packed with Solid Brass 6" Handle, Fasteners and Washers. One piece mounted.
	PULPL4016 US1BLACK	Pull Plate (Size: 0.050" x 4" x 16") Packed with Solid Brass 6" Handle, Fasteners and Washers. One piece mounted.
	PULPL715 US1 NEW ITEM	Aluminum Pull Plate (Size: 0.050" x 3 1/2" x 15") Packed with Aluminum 7" Handle, Fasteners and Washers. One piece mounted.
	PULPL916 US1 NEW ITEM	Aluminum Pull Plate (Size: 0.050" x 4" x 16") Packed with Aluminum 9" Handle, Fasteners and Washers. One piece mounted.
DOOR PULLS		
	HPUL-850 US1 NEW ITEM	Modern Hospital Double Pull Arm with Microban Anti-Microbial Coating; Aluminum Material packed with thru-bolt and finish washer includes guide sticker Dimensions: 8 1/2" x 1", 5 1/4" CTC Material Size: 3/8" x 1" Projection: 3 3/4"
	HPUSH-3515 US1 NEW ITEM	Modern Hospital Double Pull Arm with Push Plate push plate packed together with HPUL-850 Push Plate Size: 0.050" x 3 1/2" x 15"
	HPUSH-4016 US1 NEW ITEM	Modern Hospital Double Pull Arm with Push Plate push plate packed together with HPUL-850 Push Plate Size: 0.050" x 4" x 16"
	HFPUL-22 US1 NEW ITEM	Hands-Free Wrist Door Pull packed with combination screws Size: 2" x 2 3/4", Projection: 3", Gauge: 1/8"
	HFPUL-41 US1 NEW ITEM	Hands-Free Foot Door Pull packed with sexbolts & combination screws Size: 4 3/8" x 1 1/8", Projection: 3 1/16", Gauge: 1/8"



BUILDERS HARDWARE

SEPT 2020

ILLUSTRATION	ITEM NO	DESCRIPTION
DOOR VIEWERS		
	DV90 US19	Brass Door Viewer, 160°, 1/2" Bore, Plastic Lens For Doors 1 3/8" to 2 1/4" Thick. ANSI / BHMA L03172
	DV91 US19	Brass Door Viewer, 180°, 1/2" Bore, Plastic Lens For Doors 1 3/8" to 2" Thick.
	DV180 US19	Brass Door Viewer, 180°, 9/16" Bore, Plastic Lens For Doors 1 3/8" to 2" Thick. ANSI / BHMA L03171
	ULDV160 US19	UL Listed Door Viewer, 160°, 1/2" Bore; Glass Lens For Doors 1 3/8" to 2" Thick. BHMA L03172
	ULDV200 US19	UL Listed Door Viewer, 200°, 9/16" Bore Glass Lens For Doors 1 3/8" to 2 1/4" Thick.
	PRIULDV200 US19	UL Listed Privacy Door Viewer (20-Minute UL Fire Rated) Heavy Duty Privacy Rotating Cover, 200° Glass Lens 1" Head diameter; 9/16" Bore For Doors 1 3/8" to 2 1/4" Thick.
DOOR GUARDS		
	HPDL258 US19	Privacy Door Latch, Zinc Die Cast Material Height: 2 1/8", Width (Base): 1 1/2", Weight: 0.65 lbs/unit, Opening Angle: 87°
	BBDHG88 US1	Zinc Diecast Swing Bar Door Guard with Ball Bearing
	SBDG00 US1BLACK	Solid Brass Door Guard Packed with Angle Protector. Arm length 4 3/4", with Ball Bearing Comparable to IVES 482B, ANSI / BHMA L03041
	DGS39 BLACK	Door Guard Shim for BBDHG88 and PDG88. 1/8" Thick.
	DGS100 BLACK	Door Guard Shim for SBDG00. 1/8" Thick.

BUILDERS HARDWARE

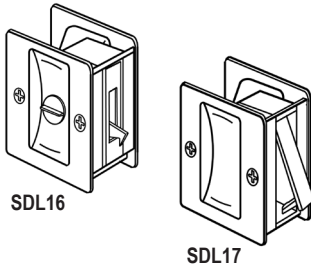
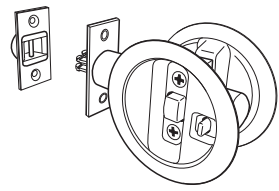
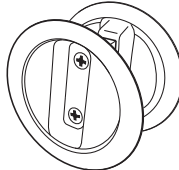
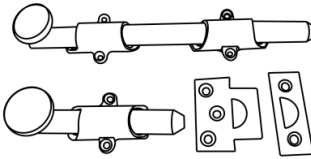
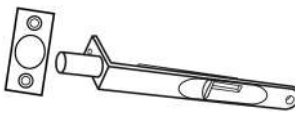
SEPT 2020

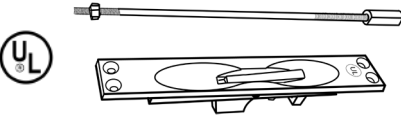
ILLUSTRATION	ITEM NO	DESCRIPTION
SLIDING DOOR LOCKS		
 <p>SDL16 SDL17</p>	SDL16 US19	Privacy Sliding Door Lock Comparable to Quality No. 101
	SDL17 US19	Passage Sliding Door Lock Comparable to Quality No. 100
	RSDL20 US19	Privacy Sliding Door Lock, 2 3/8" Backset 1 3/8" Door Thickness
	134RSDL20 US19	Privacy Sliding Door Lock, 2 3/8" Backset 1 3/4" Door Thickness
	RSDL40 US19	Dummy Sliding Door Lock, 1 3/8" Door Thickness
	134RSDL40 US19	Dummy Sliding Door Lock, 1 3/4" Door Thickness
SECURITY BOLTS		
	DDSB4 US1	Solid Brass 4" Decorative Dutch Door Bolt Packed with Mortise and Universal Strikes.
	DDSB8 US1	Solid Brass 8" Decorative Dutch Door Bolt Packed with Mortise and Universal Strikes.
	DDSB12 US1	Solid Brass 12" Decorative Dutch Door Bolt Packed with Mortise and Universal Strikes.
	DDSB18 US1	Solid Brass 18" Decorative Dutch Door Bolt Packed with Mortise and Universal Strikes.
	DDSB24 US1	Solid Brass 24" Decorative Dutch Door Bolt Packed With Mortise and Universal Strikes.
	MB85R US1	6" Solid Brass Flush Bolt Round End. 1" Throw ANSI / BHMA L04201
	MB86S US1BLACK	6" Solid Brass Flush Bolt Square End. 1" Throw ANSI / BHMA L04201
	MF6341 L1	UL Listed Solid Brass Lever Extension Flush Bolt. Commercial Type, 1" x 6 3/4", 12" Extension, 5/8" Throw. New Extruded Brass Design. ANSI / BHMA A156.16, L04081

**SOLD PER PAIR ONLY
PRICED EACH**

BUILDERS HARDWARE

SEPT 2020

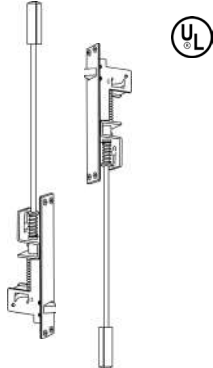
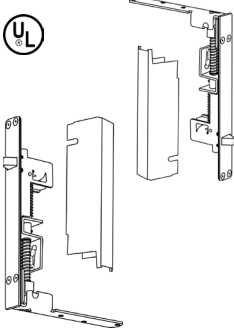
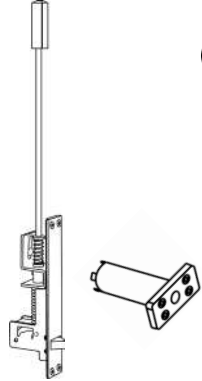
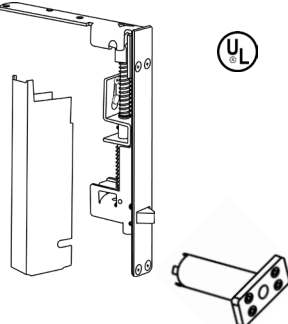
ILLUSTRATION	ITEM NO	DESCRIPTION
	<p style="text-align: center;">AUTOFLM1 US1</p>	<p>METAL DOOR AUTOMATIC FLUSH BOLTS</p> <p>Includes 2 Automatic Flush Bolts (Self-Latching Top & Bottom Combination)</p> <p>Face Plate: 1" x 6 3/4", Bolt Head: 1/2" Square Bolt Throw: 3/4", Fastener: #8 x 1"</p> <p>Steel Material, BHMA 4.4 Type 25</p>
	<p style="text-align: center;">AUTOFLW22 US1</p>	<p>WOOD DOOR AUTOMATIC FLUSH BOLTS</p> <p>Includes 2 Automatic Flush Bolts (Self-Latching Top & Bottom Combination)</p> <p>Face Plate: 1" x 8 1/2", Bolt Head: 1/2" Square Bolt Throw: 1", Fastener: #8 x 3/4"</p> <p>Steel Material, BHMA 4.4 Type 25</p>
	<p style="text-align: center;">AUXAUTOFLM1 US1</p>	<p>METAL DOOR AUTOMATIC FLUSH BOLT, Includes 1 Auto Flush Bolt (Top) & 1 Auxiliary Fire Latch (Bottom)</p> <p><u>Auto Flush bolt:</u> Face Plate: 1" x 6 3/4", Bolt Head: 1/2" Square Bolt Throw: 3/4", Fastener: #8 x 1", Steel Material</p> <p><u>Auxiliary Latch:</u> Face Plate: 1" x 1 3/4", Body: 7/8" bore x 3 1/4" Deep</p>
	<p style="text-align: center;">AUXAUTOFLW22 US1</p>	<p>WOOD DOOR AUTOMATIC FLUSH BOLT Includes Auto Flush Bolt (Top) & 1 Auxiliary Fire Latch (Bottom)</p> <p><u>Auto Flush bolt:</u> Face Plate: 1" x 8 1/2", Bolt Head: 1/2" Square Bolt Throw: 1", Fastener: #8 x 3/4", Steel Material</p> <p><u>Auxiliary Latch:</u> Face Plate: 1" x 1 3/4", Body: 7/8" bore x 3 1/4" Deep</p>

BUILDERS HARDWARE

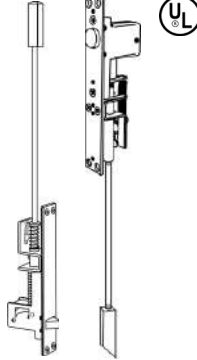
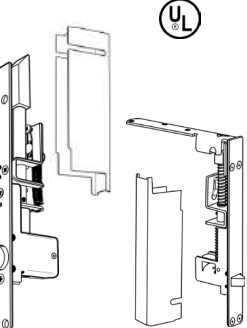
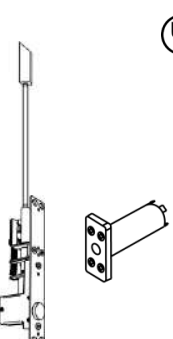
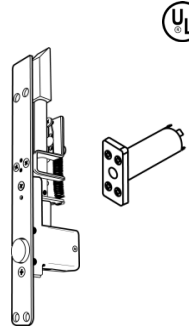
ILLUSTRATION	ITEM NO	DESCRIPTION
COMBINATION FLUSHBOLTS		
	SLAUTOFLM3 US1	<p>METAL DOOR SELF-LATCHING FLUSH BOLTS,</p> <p>Includes Self-Latching Bolt (Top) & Auto Flush Bolt (Bottom) Combination Steel Material, BHMA 4.4 Type 25</p> <p><u>Self-Latching (top):</u> Face Plate: 1" x 6 3/4", Bolt Head: 1/2" Square Bolt Throw: 3/4", Fastener: #8 x 3/4"</p> <p><u>Auto Flush bolt (bottom):</u> Face Plate: 1" x 6 3/4", Bolt Head: 1/2" Square Bolt Throw: 3/4", Fastener: #8 x 1"</p>
	SLAUTOFLW4 US1	<p>WOOD DOOR SELF-LATCHING FLUSH BOLTS</p> <p>Includes Self-Latching bolt (Top) & Auto Flush Bolt (Bottom) Combination Steel Material, BHMA 4.4 Type 25</p> <p><u>Self-Latching (top):</u> Face Plate: 1" x 8 1/2", Bolt Head: 1/2" Square Bolt Throw: 3/4", Fastener: #8 x 3/4"</p> <p><u>Auto Flush bolt (bottom):</u> Face Plate: 1" x 8 1/2", Bolt Head: 1/2" Square Bolt Throw: 1", Fastener: #8 x 3/4"</p>
	AUXSLAFLM3 US1	<p>METAL DOOR SELF-LATCHING FLUSH BOLTS</p> <p>Includes Self-Latching Bolt (Top) & Auxiliary Fire Latch (Bottom)</p> <p><u>Self-Latching (top):</u> Face Plate: 1" x 6 3/4", Bolt Head: 1/2" Square Bolt Throw: 3/4", Fastener: #8 x 3/4"</p> <p><u>Auxiliary Latch:</u> Face Plate: 1" x 1 3/4" Body: 7/8" bore x 3 1/4" deep</p>
	AUXSLAFLW4 US1	<p>WOOD DOOR SELF-LATCHING FLUSH BOLTS</p> <p>Includes Self-Latching Bolt (Top) & Auxiliary Fire Latch (Bottom)</p> <p><u>Self-Latching (top):</u> Face Plate: 1" x 8 1/2", Bolt Head: 1/2" Square Bolt Throw: 3/4", Fastener: #8 x 3/4"</p> <p><u>Auxiliary Latch:</u> Face Plate: 1" x 1 3/4" Body: 7/8" bore x 3 3/4" deep</p>

BUILDERS HARDWARE

SEPT 2020

ILLUSTRATION	ITEM NO	DESCRIPTION
	UNIFB820 US1	<p>METAL & WOOD DOOR UNIVERSAL FLUSH BOLTS</p> <p>Includes 2 Auto Flush Bolt (Top & Bottom) ANSI / BHMA A156.3-2008, Type 25</p> <p><u>Auto Flush Bolt (top & bottom):</u> Face Plate: 1 1/8" x 2 1/4" Bolt Head: 1/2" Round Bolt Throw: 3/4" Fastener: # 8 x 3/4"</p>
	UNIFB780 US1	<p>METAL & WOOD DOOR UNIVERSAL FLUSH BOLTS</p> <p>Includes Self-Latching bolt (Top) & Auto Flush Bolt (Bottom) Combination ANSI / BHMA A156.3-2008, Type 25</p> <p><u>Self-Latching (top):</u> Face Plate: 1 1/8" x 2 1/4", Bolt Head: 1/2" Square Bolt Throw: 3/4", Fastener: # 8 x 3/4"</p> <p><u>Auto Flush Bolt (bottom):</u> Face Plate: 1 1/8" x 2 1/4", Bolt Head: 1/2" Round Bolt Throw: 3/4", Fastener: # 8 x 3/4"</p>
	UNIFB930 US1	<p>METAL & WOOD DOOR UNIVERSAL FLUSH BOLTS</p> <p>Includes Self-Latching Bolt (Top) & Fire Latch Bolt (Bottom) Combination ANSI / BHMA A156.3-2008, Type 25</p> <p><u>Self-Latching (top):</u> Face Plate: 1 1/8" x 2 1/4", Bolt Head: 1/2" Square Bolt Throw: 3/4", Fastener: # 8 x 3/4"</p> <p><u>Auxiliary Latch (bottom):</u> Face Plate: 1" x 1 3/4" Body: 7/8" bore x 3"</p>
	UNIFB540 US1	<p>METAL & WOOD DOOR UNIVERSAL FLUSH BOLTS</p> <p>Includes an Auto Flush Bolt (top) & Fire Latch Bolt (bottom) Combination ANSI / BHMA A156.3-2008, Type 25</p> <p><u>Self-Latching (top):</u> Face Plate: 1" x 8 1/2", Bolt Head: 1/2" Square Bolt Throw: 3/4", Fastener: # 8 x 3/4"</p> <p><u>Auxiliary Latch (bottom):</u> Face Plate: 1" x 1 3/4" Body: 7/8" bore x 3"</p>

BUILDERS HARDWARE

ILLUSTRATION	ITEM NO	DESCRIPTION
DOOR COORDINATORS		
	DORCO1	UL Listed, Door Coordinator Frame openings: 60" and 72" Includes 18 5/8" Filler Bar (FB1858) BHMA 4.1.1 Type 21
	FB1858	Filler Bar 18 5/8" for up to 72" door
	FB3258 BLACK	Filler Bar 32 5/8" for up to 96" door
	UNICO-17 BLACK NEW ITEM	Universal Door Coordinator Used for pair of doors up to 8' wide. Stop mounted - no mounting brackets required when using stop mounted hardware. Non-Handed Adjustable arm lengths for multiple door sizes. Material: Steel Dimensions: 20 1/8" x 1 9/16" x 1 3/16" Arm Length: 7 3/4" up to 9 3/16"
	CBO-1	Carry Bar Plate: 1 3/4" x 2 1/4" Fasteners: 1/4" x 20 Sex Bolts Material: Steel
	MB4250	Mounting Brackets Jamb Depth: 4 1/4" Stop Height: 5/8" Stop Width: 2 1/4" and over
	MB4750	Mounting Brackets Jamb Depth: 4 3/4" Stop Height: 5/8" Stop Width: 7/8" to 2 1/4" and over
HANDRAIL BRACKETS		
	JUHB28 US1BLACK	Jumbo Heavy Duty Handrail Bracket Packed with Mounting Screws Height: 2 7/8", Width: 2 1/8", Projection: 2 7/8"
	HDHB40 US1BLACK	Heavy Duty Cast Aluminum Handrail Bracket Comparable to IVES #059 Height: 3 1/4", Width: 1 7/16", Projection: 3 1/4"

BUILDERS HARDWARE

SEPT 2020

ILLUSTRATION	ITEM NO	DESCRIPTION
WALL DOOR STOPS / BUMPERS		
	WB26 US19	Solid Brass Concave Wall Stop, 2 1/2" Diameter, 1 3/16" Projection, ANSI / BHMA 156.16 L12251
	SWB US19	Solid Brass Convex Wall Stop, 1" Diameter, 1/2" Projection Concealed Mounting. Comparable to IVES #404, ANSI / BHMA L02101
	SBRS3 US1BLACK	3" Solid Brass Rigid Door Stop, Packed with both White and Black Rubber Tips Comparable to IVES #64
	SBRS4 US1BLACK	4" Solid Brass Rigid Door Stop, Packed with both White and Black Rubber Tips Comparable to IVES #64
	HDFS3 US1BLACK	3 1/8" Heavy Duty Flexible Door Stop with Screw and Metal Base
	JFS13 US1BLACK	3 3/4" Heavy Duty Jumbo Spring Door Stop with Screw and Metal Base
FLOOR DOOR STOPS		
 LSDC-315 SDC-115	LSDC-315 BLACK	Security Door Stops designed for high traffic, abusive and security applications. Flame resistant, resilient material molded around a heavy-duty stud. Stud Dimensions: 5/8" x 2 1/2" Bumpers: (LSDC-315) 2" dia. x 3 1/2" h (SDC-115) 2" dia. x 1 1/2" h
	SDC-115 BLACK	
	GS118 US1BLACK	Goose Neck Cast Floor Stop 2 1/8" High, Base: 2 5/8" x 1 5/8". Combo Packed with (1) 5/16" Hanger Bolt & (1) #14 x 1" Wood Screw, 5/16" x 2 1/2" Stud with Expansion Shield and (1) 1/4 - 20 x 1" Machine Screw and Anchor. ANSI / BHMA 156.16
	GS119 US1BLACK	Goose Neck Cast Floor Stop, 2 7/8" High, Base: 2 3/4" x 1 1/2". Combo Packed with (1) 5/16" Hanger Bolt & (1) #14 x 1" Wood screw, 5/16" x 2 1/2" Stud with Expansion Shield and (1) 1/4 - 20 x 1" Machine Screw and Anchor. ANSI / BHMA 156.16

BUILDERS HARDWARE

ILLUSTRATION	ITEM NO	DESCRIPTION
FLOOR DOOR STOPS		
	DSHP18 US1BLACK	Solid Brass Dome Stop, High Profile (1 3/4" Diameter, 3/8" Thick Base) Projection: 1 3/8" ANSI / BHMA 156.16, L02161
	DSL4 US1	Solid Brass Dome Stop, Low Profile (1 3/4" Diameter, 1/8" Thick Base) Projection: 1 1/8" ANSI / BHMA 156.16, L02141
	UNDS14 US1BLACK	Heavy Duty Cast Brass Dome Stop designed for both low and high profiles. Meets ANSI / BHMA 156.16, L02141 when used as low profile w/o thresholds. Fastener : #14 x 1 1/2" wood screw with plastic shield and 1/4" - 20 x 3/4" machine screw with lead anchor Base Diameter: 1 3/4" , Base: 1/4" , Height: 1 5/8"
	EUS-03 US1	Stainless Steel, Cylindrical Floor Mount Projection: 1 9/16" Fastener: #4 x 1 1/2" Wood Screw with Plastic Plug
	EUS-05 US1	Stainless Steel, Square Floor Mount Projection: 1 9/16" Fastener: #4 x 1 1/2" Wood Screw with Plastic Plug
HINGE PIN DOOR STOPS		
	IVHP23 US1	Jumbo Heavy Duty Hinge Pin Stop with Removable Bushing, Adjustable Angle Setting. For Commercial Grade Hinges, 1/4" or 5/16" Diameter Hinge Pins. For hinge sizes: 3 1/2" x 3 1/2", 4" x 4" and 4 1/2" x 4 1/2" Individually Poly Packed. Comparable to IVES #69, 69F.
	JHP11 US1BLACK	Jumbo Hinge Pin Door Stop with Nylon Bushing Recommended for Residential Use. For hinge sizes: 3 1/2" x 3 1/2", 4" x 4" and 4 1/2" x 4 1/2"
	DSL81 US1BLACK	Light Duty Door Protector Hinge Pin Stop with Nylon Bushing. Recommended for Residential Hinges. For hinge sizes: 3 1/2" x 3 1/2" and 4" x 4"
	HP95 US1	Hinge Pin Door Stop with Nylon Bushing Recommended for residential use. For hinge sizes: 3 1/2" x 3 1/2" and 4" x 4"

BUILDERS HARDWARE

SEPT 2020

ILLUSTRATION	ITEM NO	DESCRIPTION
CLOSET HARDWARE		
	SBBC58 US1	Solid Brass Adjustable Ball Catch 1" x 2 1/8", 1/4" Radius Latch Face & Strike Strike Size: 1 3/8" x 2 1/8", Round Corner
	DIB1 US1BLACK	Adjustable Drive-In Ball Catch, Packed with Full Lip Strike, Round Corner, Poly-bagged with Screws. Strike Size: 1 3/8" x 2 1/4", Round Corner
	ARCT3350 US19	Adjustable Roller Catch, Soft latching action. Special nylon roller for silent performance. Includes brass full lip strike. Face Plate: 2 1/4" x 7/8", Bore: 13/16" x 1 3/4" Strike: 2 1/4" x 1 3/4" Lip to center: 13/16"
	BK14 US1BLACK	Bi-Fold Ball Knob Width: 1 1/4", Height: 1 3/8" Poly-bagged Individually with 1 5/8", 1 7/8" and 2" screws
	PLA2 US1(BLACK)	Back Plates For BK14, Diameter 1 3/4".
	DIFP218US1BLACK	Drive In Finger Pull without Nails 2 1/8" Diameter
<p style="font-size: small; margin-top: 10px;">FP2000 FP3000</p> <p style="font-size: small; margin-top: 10px;">FP4000</p>	FP2000 US1BLACK	Solid Brass Oval Flush Pull Dimensions: 3 9/16" x 1 5/16" x 7/16"
	FP3000 US1BLACK	Solid Brass Rectangular Flush Pull with Optional Snap-In Plate Dimensions: 3 1/8" x 1 5/16" x 7/16"
	FP4000 US1BLACK	Solid Brass Rectangular Flush Pull with Removable Back Plate Dimensions: 3 7/8" x 1 11/16" x 7/16"

BUILDERS HARDWARE

ITEM NO	DESCRIPTION
HANDICAP RESTROOM SIGNS (ADA) WITH BRAILLE	
BLM68	Men, with Braille, pictogram, text, 6" x 9"
BLMH68	Men handicap, with Braille, pictogram, text, 6" x 9"
BOYH68 BLACK	Boys handicap, with Braille, pictogram, text, 6" x 9"
BLW68	Women, with Braille, pictogram, text, 6" x 9"
BLWH68	Women handicap, with Braille, pictogram, text, 6" x 9"
GIRH68 BLACK	Girls handicap, with Braille, pictogram, text, 6" x 9"
BLRS68	Unisex restroom, with Braille, pictogram, text, 6" x 9"
BLRSH68	Unisex handicap restroom, with Braille, pictogram, text, 6" x 9"
BLNS68	No smoking, with Braille, pictogram, text, 6" x 9"
CAEXT69 BLACK	Exit, with Braille, pictogram, text, 6" x 9"
BLM1346	Men, with Braille, text, 1 3/4" x 6"
BLW1346	Women, with Braille, text, 1 3/4" x 6"
BLRS1346	Restroom, with Braille, text, 1 3/4" x 6"
AGH-69 BLACK NEW ITEM	All Gender with Men, Women, and Handicap Logo, with Braille, pictogram, text, 6" x 9"
AGR-71 BLACK NEW ITEM	All Gender with Men, Women, and Transgender Logo, with Braille, pictogram, text, 6" x 9"
AGH-48 BLACK NEW ITEM	All Gender Restroom, with Braille, text, 4" x 8"
AGH-U3 BLACK NEW ITEM	All Gender Restroom, Contrasting Triangle on 12" Circle

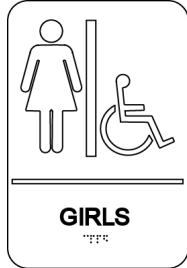

GIRH68

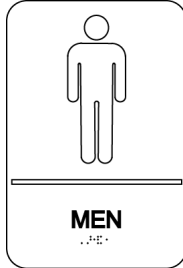

M68

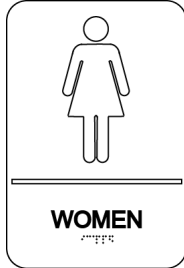

W68



RS68



NS68



CAEXT69



AGH-69

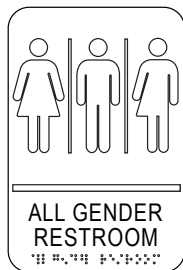

AGR-71

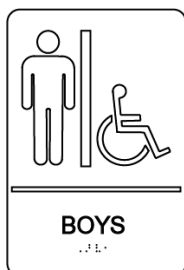

BOYH68



MH68



WH68



RSH68

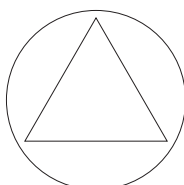

AGH-U3



AGH-48



M1346



W1346



RS1346

BUILDERS HARDWARE

ITEM NO	DESCRIPTION
HANDICAP RESTROOM SIGNS (ADA) WITH BRAILLE	
WHS5A BLACK	Women sign raised & Braille & handicap logo, 12" circle
MHS6A BLACK	Men sign raised & Braille & handicap logo, 10 1/2" high triangle
UHS7 BLACK	Unisex raised & Braille, 12" circle
UCHS10 BLACK	Unisex raised & Braille & handicap logo, 12" circle
NEWUCHS7 BLACK	Unisex raised & Braille, 12" circle
NEWUCHS10 BLACK	Unisex raised & Braille & handicap logo, 12" circle
DECALS AND STICKERS	
WDC13	This door to remain unlocked during business hours, white on black
BDC12	This door to remain unlocked during business hours, black on clear
TDUW8	These doors to remain unlocked during business hours, white on black
TDUB1	These doors to remain unlocked during business hours, black on clear
BDO-5	This door to remain unlocked when building is occupied, black on clear
WDO-11	This door to remain unlocked when building is occupied, white on black
TWOC-14	These doors to remain unlocked when building is occupied, white on black
TBOC-19	These doors to remain unlocked when building is occupied, black on clear

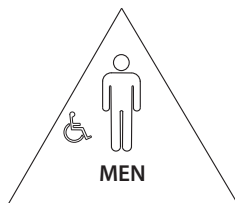

MHS6A

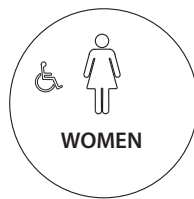

WHS5A



UHS7



NEWUCHS7



UCHS10



NEWUCHS10

THIS DOOR TO REMAIN UNLOCKED DURING BUSINESS HOURS

WDC13

THIS DOOR TO REMAIN UNLOCKED WHEN BUILDING IS OCCUPIED

WDO-11

THIS DOOR TO REMAIN UNLOCKED DURING BUSINESS HOURS

BDC12

THIS DOOR TO REMAIN UNLOCKED WHEN BUILDING IS OCCUPIED

BDO-5

THESE DOORS TO REMAIN UNLOCKED DURING BUSINESS HOURS

TDUW8

THESE DOORS TO REMAIN UNLOCKED WHEN BUILDING IS OCCUPIED

TWOC-14

THESE DOORS TO REMAIN UNLOCKED DURING BUSINESS HOURS

TDUB1

THESE DOORS TO REMAIN UNLOCKED WHEN BUILDING IS OCCUPIED

TBOC-19

BUILDERS HARDWARE



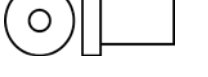
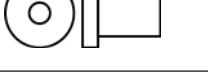
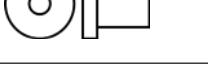



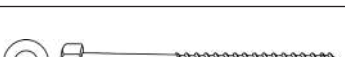
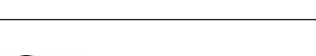



ILLUSTRATION	ITEM NO	DESCRIPTION
SDH SERIES - SLIDING DOOR HARDWARE FOR WOOD DOORS		
SET INCLUDES: 1 SLIDING ROD WITH BUILT-IN SCS80 SOFT CLOSER, 2 ACTUATORS, 2 ROLLERS, 2 STOPPERS, 1 FLOOR GUIDE AND COMPLETE MOUNTING SCREWS		
	SCS801666 BLACK NEW ITEM	Top Mount with Soft Close System Single Wheel 6' 6" (88-176 lbs.)
	SCS801682 BLACK NEW ITEM	Top Mount with Soft Close System Single Wheel 8' 2" (88-176 lbs.)
	SCS803566 BLACK NEW ITEM	Surface Mount with Soft Close System Strap Wheel 6' 6" (88-176 lbs.)
	SCS803582 BLACK NEW ITEM	Surface Mount with Soft Close System Strap Wheel 8' 2" (88-176 lbs.)
BDH SERIES - BLACK BARN DOOR HARDWARE FOR WOOD DOORS		
SET INCLUDES: 1 SLIDING TRACK, 2 ROLLERS, 2 STOPPERS, 1 FLOOR GUIDE, 2 ANTI-JUMP DISCS AND COMPLETE MOUNTING SCREWS; OPTIONAL SOFT CLOSE SYSTEM: (PREFIX SCS)		
<p>X2</p>	BDH3066 BLACK	Surface Mount, Strap Wheel 6' 6"
	BDH3080 BLACK	Surface Mount, Strap Wheel 8' 0"
	SCSBDH3066 BLACK	Surface Mount, Strap Wheel 6' 6" with Soft Close System
	SCSBDH3080 BLACK	Surface Mount, Strap Wheel 8' 0" with Soft Close System
<p>X2</p>	BDH3166 BLACK	Top Mount, Single Wheel 6' 6"
	BDH3180 BLACK	Top Mount, Single Wheel 8' 0"
	SCSBDH3166 BLACK	Top Mount, Single Wheel 6' 6" with Soft Close System
	SCSBDH3180 BLACK	Top Mount, Single Wheel 8' 0" with Soft Close System
<p>X2</p>	BDH3266 BLACK	Surface Mount, Arrowhead 6' 6"
	BDH3280 BLACK	Surface Mount, Arrowhead 8' 0"
	SCSBDH3266 BLACK	Surface Mount, Arrowhead 6' 6" with Soft Close System
	SCSBDH3280 BLACK	Surface Mount, Arrowhead 8' 0" with Soft Close System

BUILDERS HARDWARE

ILLUSTRATION	ITEM NO	DESCRIPTION
BDH SERIES - BLACK BARN DOOR HARDWARE FOR WOOD DOORS		
SET INCLUDES: 1 SLIDING TRACK, 2 ROLLERS, 2 STOPPERS, 1 FLOOR GUIDE, 2 ANTI-JUMP DISCS AND COMPLETE MOUNTING SCREWS; OPTIONAL SOFT CLOSE SYSTEM: (PREFIX SCS)		
	BDH3366 BLACK	Surface Mount, Diamond 6' 6"
	BDH3380 BLACK	Surface Mount, Diamond 8' 0"
	SCSBDH3366 BLACK	Surface Mount, Diamond 6' 6" with Soft Close System
	SCSBDH3380 BLACK	Surface Mount, Diamond 8' 0" with Soft Close System
	BDH3466 BLACK	Surface Mount, Horseshoe 6' 6"
	BDH3480 BLACK	Surface Mount, Horseshoe 8' 0"
	SCSBDH3466 BLACK	Surface Mount, Horseshoe 6' 6" with Soft Close System
	SCSBDH3480 BLACK	Surface Mount, Horseshoe 8' 0" with Soft Close System
BDH SERIES LESS TRACK - FOR WOOD DOORS		
SET INCLUDES: 2 ROLLERS, 2 STOPPERS, 2 ANTI-JUMP DISCS, 1 FLOOR GUIDE & COMPLETE MOUNTING SCREWS		
	BDH30LT BLACK	Surface Mount Strap Wheel Less Track
	BDH31LT BLACK	Top Mount Single Wheel Less Track
	BDH32LT BLACK	Surface Mount Arrowhead Less Track
	BDH33LT BLACK	Surface Mount Diamond Less Track
	BDH34LT BLACK	Surface Mount Horseshoe Less Track



BUILDERS HARDWARE

SEPT 2020

ILLUSTRATION	ITEM NO	DESCRIPTION
BDH SERIES - BLACK BARN DOOR HARDWARE ACCESSORIES		
	BDH-SPC-55 BLACK	55mm (2 3/16") Barn Door Spacer
	BDH-SPC-50 BLACK	50mm (2") Barn Door Spacer
	BDH-SPC-45 BLACK	45mm (1 3/4") Barn Door Spacer
	BDH-SPC-40 BLACK	40mm (1 9/16") Barn Door Spacer
	BDH-SPC-34 BLACK	34mm (1 5/16") Barn Door Spacer
	BDH-SPC-29 BLACK	29mm (1 1/8") Barn Door Spacer
	BDH-SCRW-130 BLACK	130mm (5 1/8") Barn Door Mounting Screws
	BDH-SCRW-120 BLACK	120mm (4 3/4") Barn Door Mounting Screws
	BDH-SCRW-110 BLACK	110mm (4 5/16") Barn Door Mounting Screws
	BDH-SCRW-100 BLACK	100mm (3 15/16") Barn Door Mounting Screws
	BDH-SCRW-090 BLACK	90mm (3 9/16") Barn Door Mounting Screws
	BDHBOLT134	Long Bolts for 1 3/4" thick doors
	BDHBOLT138	Short Bolts for 1 3/8" thick doors
	BDHAJP	Barn Door Anti-Jump Discs. Sold in Pairs

BUILDERS HARDWARE

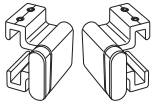
SEPT 2020

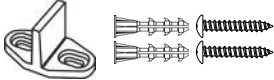
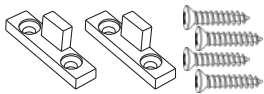
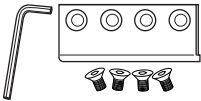
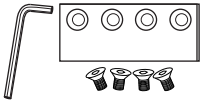
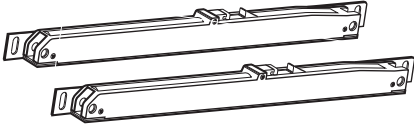
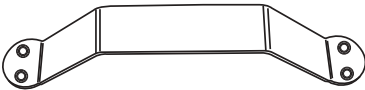
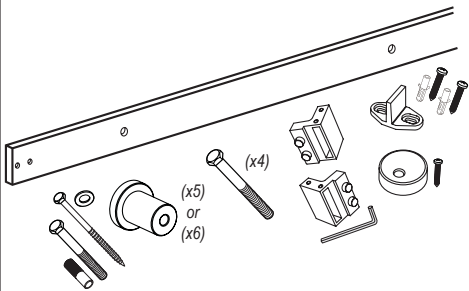
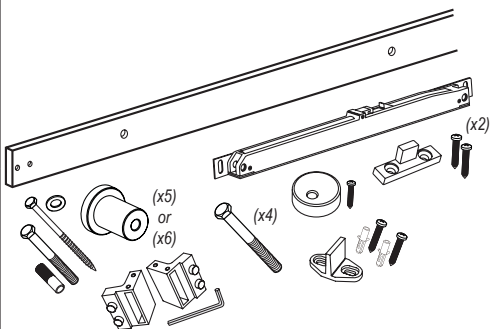
ILLUSTRATION	ITEM NO	DESCRIPTION
BDH SERIES - BLACK BARN DOOR HARDWARE ACCESSORIES		
	BDHSTP-OPN BLACK	Adjustable Barn Door Stoppers that can slide past the lag bolt. Sold in Pairs.
	BDHSTP-CLS BLACK	Fixed Barn Door Stoppers to keep rollers from sliding on both ends. Sold in Pairs.
	BDHFG	Barn Door Floor Guide
	BDH-SCWD-ACT BLACK	Wood Door Actuators for BDH Soft Close System. Sold in Pairs.
	BDHCP BLACK	Barn Door Connector Plate
	BDHCP-SLIM BLACK	Slim Barn Door Connector Plate
	SCSBDH BLACK	BDH Soft Close System for replacement only. Includes (2) Actuators and set screws.
	BDPUL6000 BLACK	Flat Type, Barn Door Pull Handle 9 1/2" x 1 1/4" x 2"
	FTRACK66 BLACK	6'6" Sliding Track with Accessories, (5) Spacers and Screws, (1) Floor Guide, (2) Anti-Jump Discs and Stoppers, (4) BDHBOLT134
	FTRACK80 BLACK	8'0" Sliding Track with Accessories, (6) Spacers and Screws, (1) Floor Guide, (2) Anti-Jump Discs and Stoppers, (4) BDHBOLT134 and BDHBOLT138
	SCBAR3066 BLACK	6'6" Sliding Track with Accessories, (2) SCSBDH, Actuators, Stoppers, (5) Spacers and Screws, (1) Floor Guide, (2) Anti-Jump Discs, (4) BDHBOLT134
	SCBAR3080 BLACK	8'0" Sliding Track with Accessories, (2) SCSBDH, Actuators, Stoppers, (6) Spacers and Screws, (1) Floor Guide, (2) Anti-Jump Discs, (4) BDHBOLT134

BUILDERS HARDWARE

ILLUSTRATION	ITEM NO	DESCRIPTION
SDH AND BDH SERIES - SLIDING DOOR HARDWARE ACCESSORIES		
<p>PULL-15778-BTB PULL-2815 FFP-28</p>	FFP-28 BLACK	Rectangular Mortised Door Handle for Wood Doors, Dimensions: 8" x 2 1/16", 7 3/32" CTC Door Thickness: 1 3/8" - 1 3/4"
	PULL-2815 BLACK	Sliding Door Handle Pull for Wood Doors Door Handle Pull: 11 7/8" x 1" Rectangular Mortised Door Handle: 8" x 2 1/16" Door Thickness: 1 3/8" - 1 3/4", 7 3/32" CTC
	PULL-15778-BTB BLACK	Back to Back Door Pull Handle for Wood Doors Dimensions: 11 7/8" x 1", 7 3/32" CTC Door Thickness: 1 3/8" - 1 3/4"
<p>SQP-012 PULL-60 FFP-250</p>	FFP-250 BLACK NEW ITEM	Round Corner, Door Handle for Wood Doors, Dimensions: 8 21/32" x 2 3/8", 7 3/32" CTC Door Thickness: 1 3/8" - 1 3/4"
	PULL-60 BLACK NEW ITEM	Sliding Door Handle Pull for Wood Doors Door Handle Pull: 11 13/16" x 1" Round Corner Surface Mounted Door Handle: 8 21/32" x 2 3/8" Door Thickness: 1 3/8" - 1 3/4", 7 3/32" CTC
	SQP-012 BLACK NEW ITEM	Back to Back Square Pull Handle for Wood Doors, Dimensions: 12" x 2 1/2" x 25/32", 11 7/32" CTC Door Thickness: 1 3/8" - 1 3/4"
<p>FFP-200 PULL-510 FFP-300</p> <p>FFP-214 FFP-215</p> <p>SDH-FG-ADJ8</p> <p>SDH-FG-ADJ1</p> <p>SDLFP</p>	PULL-510 BLACK NEW ITEM	Rustic Barn Door Handle, Surface Mounted for Wood Doors, 7" CTC Dimensions: Approx. 12" x 1" x 1", Door Thickness: 1 3/8" - 1 3/4" supplied with (2) long bolts and hammered square washers.
	FFP-300 BLACK NEW ITEM	Rustic Pocket Door Pull for Wood Doors, 4 3/32" CTC Dimensions: Approx. 2 5/8" x 5 1/8" x 1 1/8" Door Thickness: 1 3/8" - 1 3/4"
	FFP-200 BLACK	2" x 13/32" Round Door Handle for Wood Doors 5/16" hole diameter thru door Door Thickness: 1 3/8" - 1 3/4"
	FFP-214 BLACK	2 3/16" x 13/32" Round Door Handle for Wood Doors 3/8" hole diameter thru door Door Thickness: 1 3/8" - 1 3/4"
	FFP-215 BLACK	2 1/2" x 11/32" Round Door Handle for Wood Doors 1 27/32" hole diameter thru door Door Thickness: 1 3/8" - 1 3/4"
	SDH-FG-ADJ1 BLACK NEW ITEM	Adjustable Floor Guide for both pre-grooved and non-grooved wood doors. Front Arm: 1 3/4" x 1 3/4", Back Arm: 1 1/8" x 1" Door Thickness: 1 3/8" - 1 3/4"
	SDH-FG-ADJ8 BLACK NEW ITEM	Adjustable Floor Guide Roller for non-grooved wood doors. 2" (H) x 1 9/16" (W) x 4 1/8" (L) Door Thickness: 13/16" - 2 3/16"
	SDLFP BLACK	4 5/8" x 1 1/4" Flip Privacy Sliding Door Lock with Strike Plate and Emergency Key Door Thickness: 1 3/8" - 1 3/4"