

PL7000 USER MANUAL



TABLE OF CONTENTS

Introduction	1	Key Butler User Manual	7
Requirement	1	Using only RFID card and no smartphone	8
NFC Compatible Smartphone	1	DIN	9
Mifare Compatible Access Cards	1	Low Battery	9
Administrator and Clients	2	Resetting to Factory Default	10
Status LED	3	Events and Beeps	12
Sensor Area	4	Troubleshooting	13
Battery Cover and Setup Button	4	Specifications	14
User Smartphones	5		
Install App	5		

REGULATORY COMPLIANCE

The device complies with Part 15 of the FCC Rules. Operation is subject to the following two conditions:

- (1) This device may not cause harmful interference, and
- (2) This device must accept any interference received, including interference that may cause undesired operation.

FCC WARNING STATEMENT

You are cautioned that changes or modifications not expressly approved by the part responsible for compliance could void the user's authority to operate the equipment.

This equipment has been tested and found to comply with the limits for a Class B digital device, pursuant to part 15 of the FCC rules. These limits are designed to provide reasonable protection against harmful interference in a residential installation. This equipment generates, uses and can radiate radio frequency energy and, if not installed and used in accordance with the instructions, may cause harmful interference to radio communications. However, there is no guarantee that interference will not occur in a particular installation. If this equipment does cause harmful interference to radio or television reception, which can be determined by turning the equipment off and on, the user is encouraged to try to correct the interference by one or more of the following measures:

- Reorient or relocate the receiving antenna.
- Increase the separation between the equipment and receiver.
- Connect the equipment into an outlet on a circuit different from that to which the receiver is connected.
- Consult the dealer or an experienced radio/TV technician for help.

Introduction

Requirement

Apart from the key, you can use NFC-ready smartphones or contactless RFID cards to unlock this lock. The built-in NFC module allows the PL7000 to be unlocked with NFC compatible smartphones or MIFARE compatible contactless RFID cards. This gives users access easier, safer, and more convenient.



NFC Compatible Smartphone

PL7000 is designed to communicate with NFC interface, so please choose smartphones which support NFC function to be a client or an administrator.



MIFARE Compatible Contactless Card

PL7000 can also be unlocked by contactless cards. The cards must be compatible with MIFARE (13.56Mhz) standards.

Administrator & Clients

An NFC-ready smartphone with a Key Butler app installed, or a contactless RFID card, is called a USER. For a USER to unlock a lock, it must become a registered USER of the lock. Only registered USERS can unlock the lock.

There are two types of USERS. The first one is the Administrator. A lock can only have one Administrator at a time. Besides unlocking, the Administrator is also responsible for managing the lock and all the registered Clients. Only smartphones can be used as Administrators, RFID cards are only used as a CLIENT, for unlocking. An Administrator can manage multiple locks.

The second type of USER is a Client. A lock can have multiple Clients. A Client can unlock the lock, but not manage it. Both smartphones and contactless cards can be used as Clients.

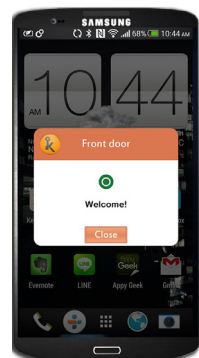
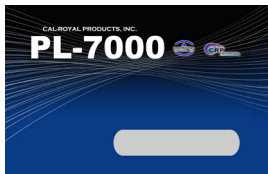

Status LED

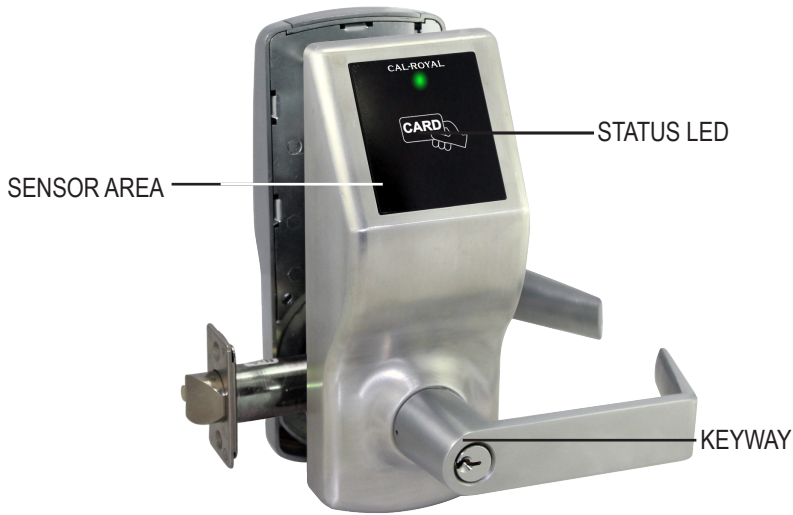

EXTERIOR

Status LED

The Status LED indicator located on the head of the lock which indicates the operating status of the lock.

Flashing Red LED ●

When an INVALID USER tries to unlock, the status LED will flash red, and will generate an audible warning sequence of beeps*

Flashing Green LED ●

When a VALID USER tries to unlock, the status LED will flash green, and a series of audible beeps* will be heard

*Refer to page 15 'Events and Beeps'

SENSOR AREA

Near Field Communication (NFC) is a set of standards for smartphones and similar devices to establish radio communication with each other by touching them together or bringing them into proximity, typically a distance of 10cm (3.9 in) or less.



Different smartphones have different antennas and may not be in the same location. Make sure to locate the best sensor area for your phone and RFID cards.

BATTERY COVER and SETUP BUTTON

The battery cover can be removed by unscrewing the battery cover screw. Behind the cover is where the setup button is located.

SETUP
BUTTON



BATTERY
COVER
SCREW

BATTERY
COVER

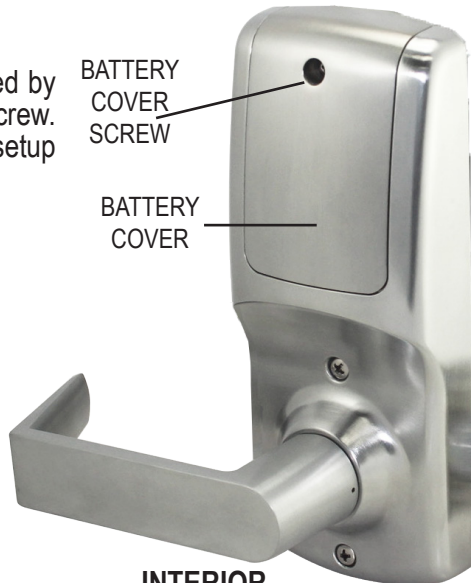

INTERIOR

USER SMARTPHONES

All smartphone users must install the “Key Butler” app, whether as an Administrator or a Client. Make sure you have an internet connection or you have a data plan in order for you to download and install the free app from the “Play Store”.

INSTALL APP

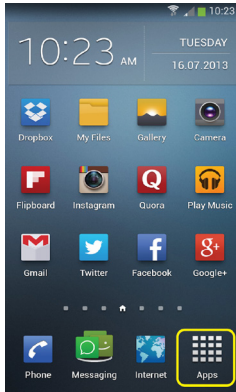

STEP 1
Open APPS Group

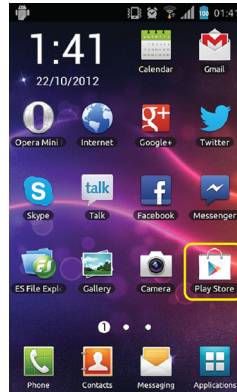

STEP 2
Tap Play Store

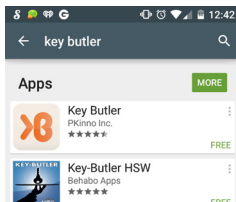

STEP 3
Search and choose
KEY BUTLER

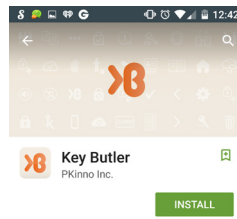

STEP 4
Tap INSTALL

INSTALL APP

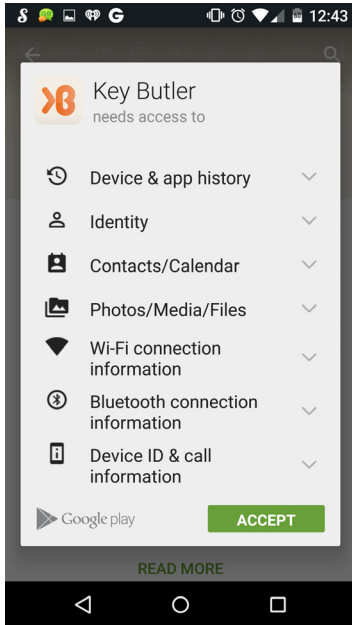

STEP 5
Read permission and tap ACCEPT

STEP 6
Tap OPEN to start APP

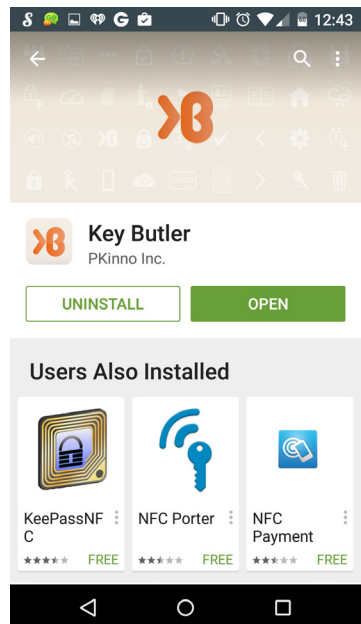

KEY BUTLER USER MANUAL

OPENING USER MANUAL

Tap the settings icon

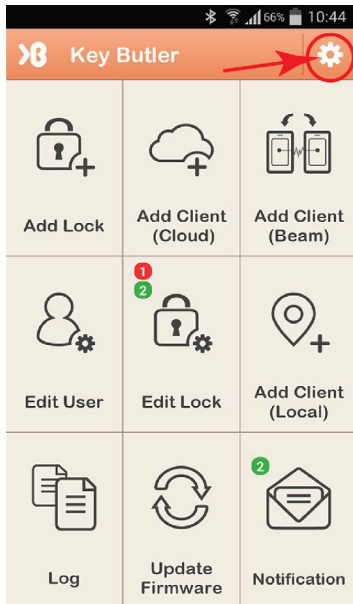

TAP
User Manual option

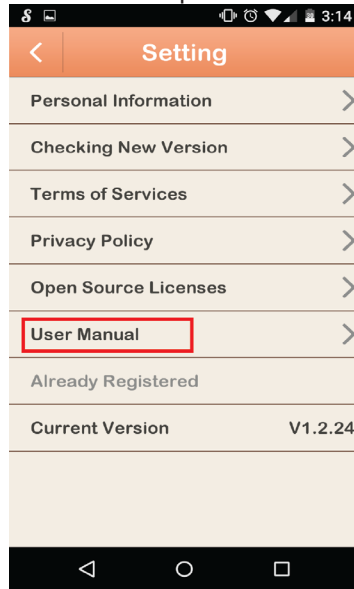

or check the website:

<http://www.keybutlerapp.com/manual.html>

USING ONLY RFID AND NO SMARTPHONE

In cases where smartphones will not be used to open the lock and only RFID cards, you can use the BATCH mode to ADD and DELETE cards.

1. Push the **SETUP BUTTON** in the battery compartment

SETUP BUTTON



SET UP BUTTON MODES

Push for 1 second

ADD users, but ADMINISTRATOR will be DELETED if already setup

Push for 5 seconds

ADD users, but existing USERS and ADMINISTRATOR will be DELETED if already setup

2. Tap the RFID card in front of the lock, when the ascending beep is heard the card is registered as a user of the lock. All original clients will be deleted and the administrator will be deleted as well.

3. Multiple cards can be enrolled, one after the other until the setup button is pressed, otherwise enrollment will terminate when the lock times out after a few seconds of inactivity.



4. There are 2 BATCH SET UP MODES

- 4.1 Push setup button for 1 second to add tapped rfid cards and delete existing ADMINISTRATOR
- 4.2 Push setup button for 5 seconds to add tapped rfid cards and delete existing administrator users

DIN

The PL7000 comes with a default DIN which is all lower case “pl7000”. This DIN number is needed when pairing a new lock to a smartphone for the first time as an administrator.

LOW BATTERY

The PL7000 has a low battery warning function that can be seen everytime a phone is used to unlock it.

When the battery is at a low state, there are two distinguishing sound that are emitted:

1. During successful unlock, the sound is 1 beep then 10 beeps for low battery warning
2. During failed unlock, the sound is same as an invalid user unlock tone.

RESETTING TO FACTORY DEFAULT

To reset the lock to factory setting, do the following steps:

STEP 1

Remove battery cover and take out one battery.



STEP 2

Keep SETUP BUTTON pressed

SETUP BUTTON



STEP 3

Replace the battery while pressing the setup button



STEP 4

Wait for 4 beeps then release the setup button. The lock will be reset to factory setting and all previously created users and administrator will be removed. Replace the battery cover.



EVENTS AND BEEPS

EVENTS	BEEPS
Phone or Card swipe	3 ascending tone beep
Low Battery, Successful Unlock	1 beep, 10 beeps for low battery warning
Phone or Card Unlock Fail	1 long and 4 short beeps, the long beep tone is higher
Low Battery, Unlock Fail	1 long and 4 short beeps, the long beep tone is higher
ADD User Successful	4 beeps ascending tone scale
ADMIN pairing Successful	4 beeps ascending tone scale
COMMUNICATION Issue	2 low pitch scale
Pushing SETUP Button	2 short beeps
Exiting SETUP Mode	2 short and 1 long beep

- When a USER tries unsuccessfully for 3 consecutive tries, the lock will emit 10 beeps and be in TIMEOUT mode for two minutes

TROUBLESHOOTING

PROBLEM	SOLUTION
Lock not responding	Change batteries and try again
Lock is working but no audible sound	If unlocking function is normal, but no sound can be heard from the lock, check if parameter setting is in MUTE mode. Check "LOCK CONFIGURATION" of Key Butler user manual parameter setting
Administrator phone becomes an invalid user	An Administrator may lose administration rights when any of the following happened: <ol style="list-style-type: none"><li data-bbox="540 551 952 620">1. Another phone was setup as an administrator.<li data-bbox="540 670 952 818">2. BATCH Mode 1-sec or 5-sec options were used that caused the administrator to be removed from the lock memory.<li data-bbox="540 867 952 891">3. The lock was reset to factory set

SPECIFICATION

COMMUNICATION

Type : NFC (Near Field Communication)

Radio Frequency : 13.56 Mhz

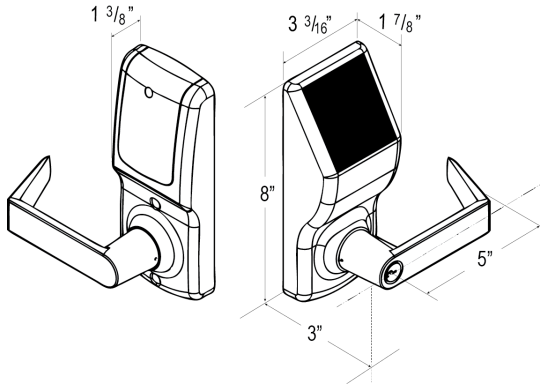

DISCLAIMER: Cal-Royal Products does not claim that this lock can provide complete security by itself. This lock may be defeated by forcible or technical means, or evaded by entry elsewhere on the property like any other locks. No lock can substitute for vigilance, awareness of your environment, and common sense. Builder's hardware is available in multiple performance grades to suit the application. In order to enhance security and reduce risk, you should consult a qualified locksmith or other security professional.

Notice of Open Source Licenses

[FreeRTOS]

This product uses FreeRTOS v7.3.0. The source code of FreeRTOS used can be downloaded here:
<http://sourceforge.net/projects/freertos/files/>

[OpenSSL]

This product uses OpenSSL, and the OpenSSL license can be downloaded here:
<http://www.openssl.org/source/license.html>

This product includes software developed by the OpenSSL Project for use in the OpenSSL Toolkit.
(<http://www.openssl.org/>)

This product includes cryptographic software written by Eric Young (eay@cryptsoft.com).

This product includes software written by Tim Hudson (tjh@cryptsoft.com).