

- CAL-ROYAL'S FINEST DOOR CLOSER SERIES MEETING THE HIGHEST INDUSTRY STANDARDS, GRADE 1
- HEAVY-DUTY FULL FEATURE MULTI-SIZE COMMERCIAL DOOR CLOSER FOR USE IN OFFICE BUILDINGS, SHOPPING CENTERS AND OTHER COMMERCIAL BUILDINGS
- STANDARD BACK-CHECK FUNCTION
- FULL PLASTIC COVER IS STANDARD FEATURE. (METAL OPTIONAL)
- DECORATIVE COVERS (US 3, US 26) ARE AVAILABLE
- OPTIONAL ADJUSTABLE DELAYED ACTION/BARRIER FREE FOR HANDICAPPED OR ELDERLY

900 Series Door Closer

*Full Cover Multi-size Full Feature Closer
ANSI 156.4 Grade 1*

*UL Listed. Conforms To Standards
UL10C and UBC7-2-1997*



CAL-ROYAL
P R O D U C T S, I N C.



*UL Listed, Conforms To Standards
UL10C and UBC7-2-1997*

900 Series Door Closer

LISTED

Conforms To Standards UL10C and UBC7-2-1997

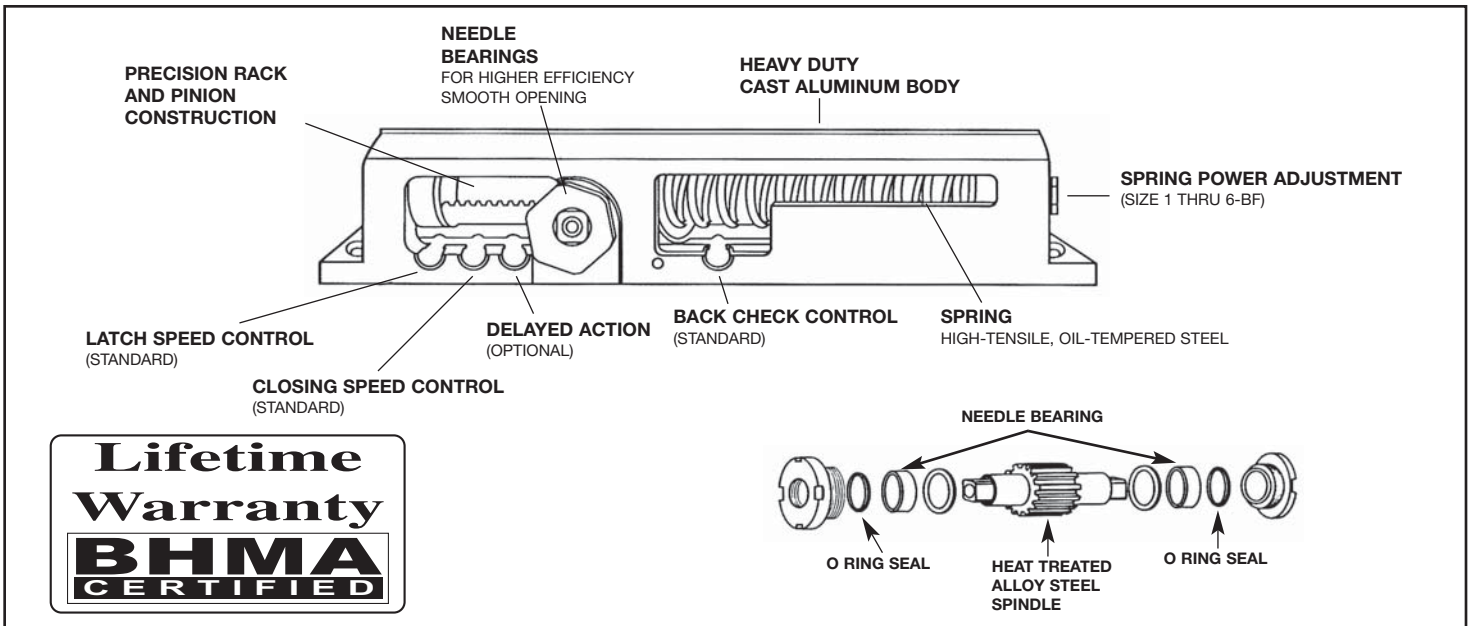

FEATURES

- Universal application. Non-handed for standard, top-jamb or parallel arm installation
- Non-sized, 1 thru 6 FACTORY PRESET SIZE 3
- Standard adjustable back-check function
- Adjustable closing and latching speed by two separate regulating valves
- Standard full plastic cover



- Extended long arm for top jamb mount with deep reveals. 900 EXT
- ANSI 156.4 Grade1: UL listed for fire door assemblies
- Available in Alum, Duro, Gold, US3, 26, 26D, 10A and US5 Finishes
- Optional adjustable delayed action (DA) Preset at the factory for approximately 20 seconds, between 70° and 0° Delay time easily adjusted up to 1 minute
- Barrier free (BF) Meets ADA regulation. Size 1 thru 6. Engineered with reduced spring power to provide easier opening for handicapped or elderly.

ACCESSORIES

- Parallel hold-open adjustable arm (Non handed). 901/902
- Fusible link hold-open arm (Non handed). FUS707 melting point of 125° F (52°C)
- Optional Metal cover
- Optional, non-handed parallel arm features solid forged steel main arm and forearm with stop in soffit shoe. SPAS/900
- Optional, non-handed parallel arm features solid forged steel main arm and forearm provides hold-open function with templated stop/hold-open points. Handle controls hold-open function. HOSRPS/900
- Slide track arm. TRACK/900 with hold open
- Flat drop bracket 950

DESCRIPTION	SIZE
A. Length of Closer Body	11 3/4"
B. Horizontal Mounting Holes	11 1/8"
C. Vertical Mounting Holes	9/16"
D. Width of Closer Body	2"
E. Projection from Door	2 7/8"

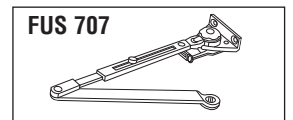
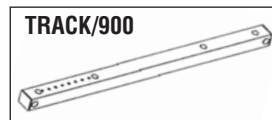
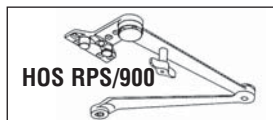
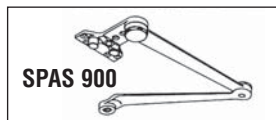
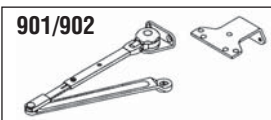

CROSS REFERENCES

CAL-ROYAL	CORBIN	DORMA	LCN	LCN	NORTON	RUSSWIN	SARGENT	YALE
900 FULL COVER	120K	7800FCOV/ 7600FCOV	1460-72G	4040	8501	2820K	1230	3501

The data on this chart represents our judgement of which are most similar. Since no product is exactly alike the information has been obtained from trade sources. It is not guaranteed nor represented that any specific product exactly equals any other product. Door closer body size may be different.

CAL-ROYAL
PRODUCTS, INC.

6605 FLOTILLA ST., COMMERCE, CA 90040 U.S.A.

TEL: (323) 888-6601 FAX: (323) 888-6699

Website: cal-royal.com • Email: sales@cal-royal.com