



CAL-ROYAL

P R O D U C T S, I N C.



5000 & F5000 Rim Type Panic And Fire Exit Devices 5000V & F5000V Vertical Rod Panic And Fire Exit Devices ANSI A156.3, Grade 2



**Lifetime
Warranty**

Features & Construction

- ◆ ANSI A156.3, Grade 2 heavy duty exit device in surface vertical rod and rim designs.
- ◆ UL Listed for Panic and UL10C, UBC 7-2-1997 codes.
- ◆ UL Listed for Fire Exit Hardware. 3 hours.
- ◆ Conforms & Meets ADA Regulations.
- ◆ (A) label rating on pairs of doors up to 8'0" x 8'0" swinging in same or opposite directions.
- ◆ Uncompromising security and safety in single and double fire exit doors.
- ◆ Chassis mounted unit construction.
- ◆ Available in standard functions. Lever and knob trims are grade 2 construction with optional clutch freewheeling mechanism. Rose covers 161 cut out.

Suggested Architect's Specifications

- ◆ All exit devices shall be of touch bar design with smooth operation and be operative over 2/3 of the door's clear opening width.
- ◆ All exit devices must be listed under "Panic Hardware" in the Accident Equipment List of Underwriters' Laboratories, Inc. Where labeled doors are used as exits, they must be equipped with labeled Fire Exit Hardware and UL10C, UBC 7-2-1997 codes.
- ◆ All exit devices shall be of chassis mounted unit construction.

5000 & F5000 Series

Rim Type Exit Device



Specifications

- For Doors** _____ 1 3/4" thick standard 3 3/4" minimum stile width required for single or double door application using standard 240 strike and pull or lever trims.
- Chassis** _____ Steel (Panic Grade), steel (Fire Grade).
- Cover** _____ Covers stock hollow metal doors with 161 cutout.
- Mounting** _____ Furnished standard with wood and machine screws. Available with thru bolts on request. Thru bolts are standard packaging on fire rated devices.
- End Cap** _____ Steel construction.

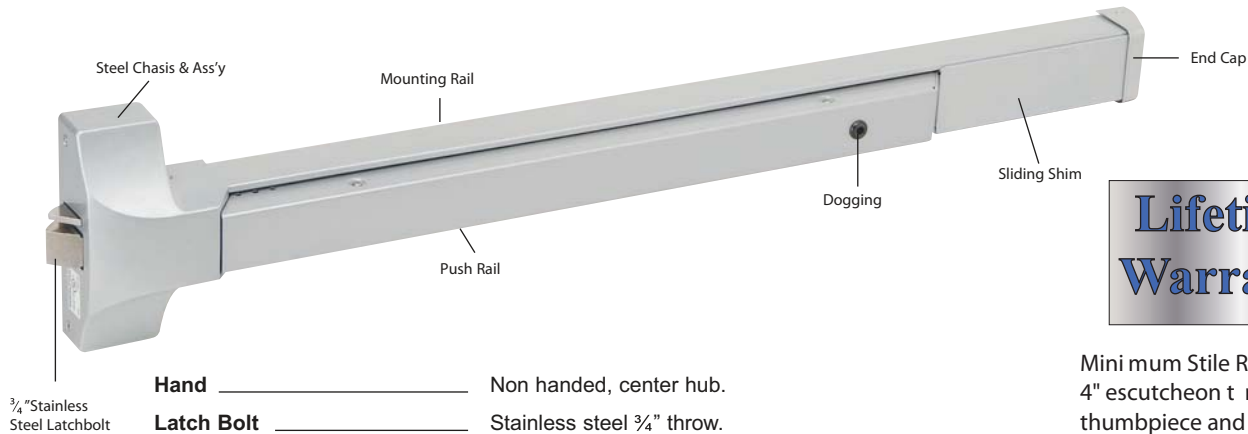

Lifetime Warranty

- Hand** _____ Non handed, center hub.
- Latch Bolt** _____ Stainless steel 3/4" throw.
- Spring** _____ Steel throughout.
- ANSI Standard** _____ A156.3, Grade 2.
- Rail Assembly** _____ Heavy gauge steel, painted.
- Strike** _____ 240 packed standard (See strike page).
- Dogging Feature** _____ Allen-type key furnished standard on non-fire labeled devices.
- Mullion** _____ Available.
- UL and ULC Listed** _____ 5000 Series for panic. F5000 Series for fire exit hardware for all types of 3' x 7' single doors and 6' x 7' double doors for up to 3 hour fire labeled installations, conforms to standards UL10C and UBC 7-2-1997 codes.
- Finish** _____ Aluminum (alum), US32D (Stainless Steel).

Minimum Stile Requirements
4" escutcheon trims & 4 1/2" for thumbpiece and rose trims

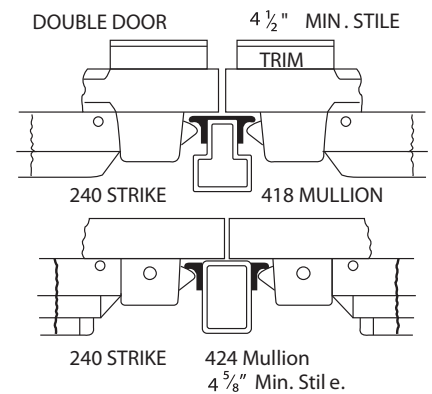

DIMENSIONS

| | |
|-----------------------------------|------------------------|
| Touchbar height to finished floor | 41" (1043mm) at center |
| Touchbar projection | |
| neutral | 1/2" (64mm) |
| depressed | 1 3/4" (45mm) |

| MODEL SIZE | ACTUAL LENGTH | MAXIMUM CUT DOWN | DOOR SIZE |
|------------------------|---------------|------------------|-----------------------|
| 5000EO36 and F5000EO36 | 32" | 6" | 30" to 36" door width |
| 5000EO48 and F5000EO48 | 39" | 12" | 31" to 48" door width |

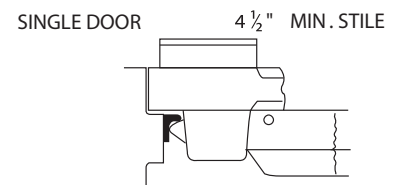

Trim Selection

LEVER DESIGN

Non handed Grade 2 (Optional Clutch)
 Tubular body hardened steel heavy duty tailpiece.
 For 1³/₄" doors. Available for fire and non fire rated rim and vertical rod exit devices.
 Rose diameter 3¹/₂", lever length 4³/₄". Fits and covers 161 cutout.

Finishes: US26D, 10B, 3

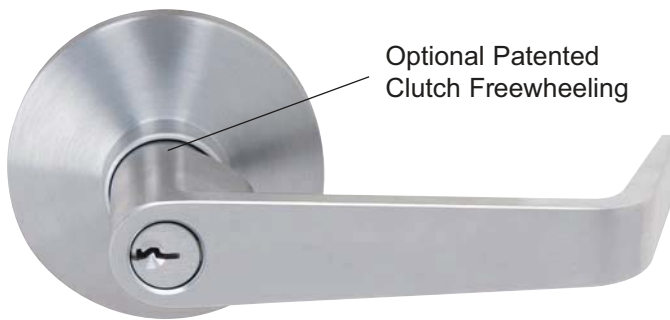

8000/L **ENTRANCE**
 Key locks and unlocks lever.
 Operates as classroom function.
 ANSI Function - 08

CLU5000 L **CLUTCH FREE WHEELING (ENTRANCE)**
 Key locks and unlocks lever.
 Operates as classroom function.
 ANSI function - 08

8000/S **STOREROOM**
 Key retracts latchbolt, otherwise always locked.
 ANSI function - 04

8000/PAS **PASSAGE**
 Lever always operable and free.
 ANSI function - 15

8000/DUM **DUMMY**
 Dummy trim. One sided.
 ANSI function - 10

KNOB DESIGN

Non handed Grade 2
 Tubular body hardened steel heavy duty tailpiece.
 For 1³/₄" doors. Available for fire and non fire rated rim and vertical rod exit devices.
 Rose diameter 3¹/₂". Fits and covers 161 cutout.

Finishes: US32D, 10B, 3



8000/K **ENTRANCE**
 Key locks and unlocks knob.
 Operates as classroom function.
 ANSI Function - 08

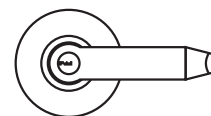
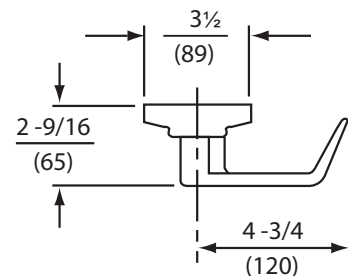

KEYWAY: 6 pin solid brass "C" keyway standard. Optional: Schlage E, Schlage C-K, Russwin D1-2-3-4, Corbin 59/60, Sargent LA-LB-LC, Falcon/Weiser E, Arrow, Yale 8, Yale GA and Kwikset. Can also accept Medeco, Assa and Kaba High Security Cylinders.

Trim Selection

PULL DESIGN

FOR RIM DEVICES ONLY

Outside by pull and key.
Key retracts latchbolt.
ANSI function - 03
Covers 161 cutout.

FINISHES

Powder coated aluminium (alum).

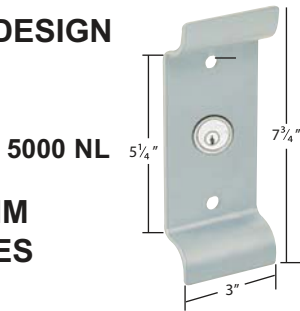

5000 DTP

Outside by pull only.
Pull when dogged.
ANSI function - 02
Covers 161 cutout.



5000 EOP

Outside by plate only.
ANSI function - 10
Covers 161 cutout.



Strikes & Accessories

Strikes for use with 5000V vertical rod exit device

All strikes are black nylon coated

221
Standard for 5000V.
Applied to surface of floor or to a flat threshold.
Standard packaging.

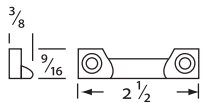

227
Applied to surface of stop.
No mortise required.
Standard packaging.

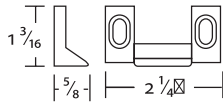

233
Bottom strike. Alternate bottom Strike. Flush mounting stainless steel. Furnished with expansion shields. Requires mortise in the floor.

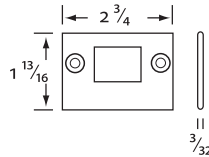

Strike for use with 5000 rim type exit device

240
For 5000 surface applied. Standard packaging.

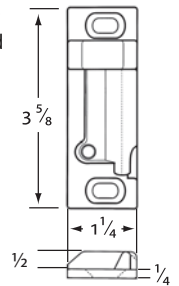

RIM 238

Strike for 2 3/8" Backset Application

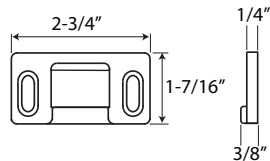

Strikes for use with F5000V vertical rod fire rated exit device

245
Surface applied for F5000V.
Standard packaging.

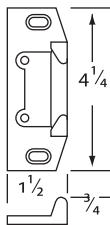

233
Bottom strike for F5000V.
Flush mounting stainless steel.
Furnished with expansion shields.
Requires mortise in the floor.
Standard packaging.

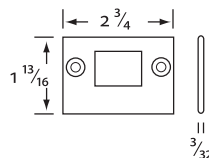

Strike for use with F5000 rim fire exit device

240
For F5000 surface applied, Standard packaging.

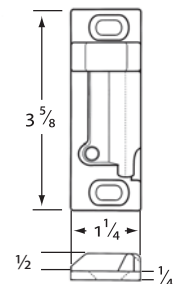

Overlapping Strike

254
Surface applied. Used on inactive leaf for device on active leaf of pair of doors without mullion.

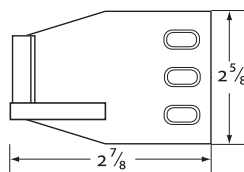

Additional Accessories

LFF
Lock front filler.

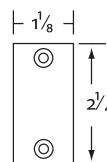

SF
Strike filler.

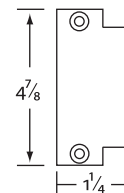

Accessories



MULLIONS

418 – Removable mullion Aluminum painted (Prime coat) includes top and bottom retainer supplied as a stock 96" for non fire rated applications.

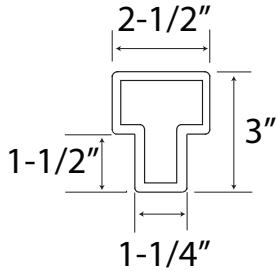

LCK418 – Lockable Removable mullion Aluminum painted (Prime coat) includes top and bottom retainer supplied as a stock 96" for non fire rated applications.



ICLCK418 - Interchangeable core locks will accept compatible 6 or 7 pin cores with BEST, FALCON and ARROW.



ICSLCK418 - Indicates function available with **Schlage Full size format** Interchangeable Core.

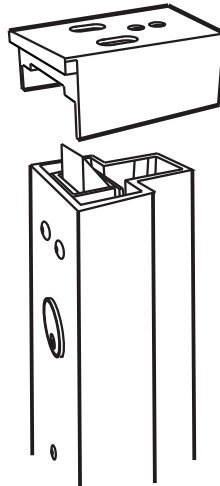

424 – Fire exit mullion. 2" x 3" x 96" steel tubing round corner, iron construction with iron top and bottom retainers. To be used with two rim type devices on two independent active doors with full double door openings.

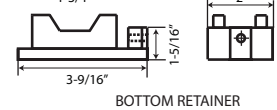
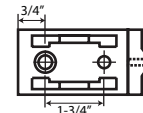
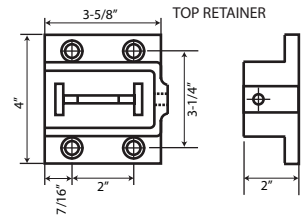
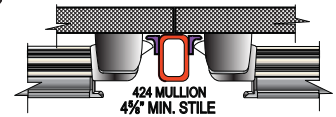

Electric lockable mullions are available on request.



Fire Exit Hardware Selector ●●●●●●

| FIRE EXIT HARDWARE | | | UL FIRE DOOR RATING |
|---|-------------------------------|----------------------|---------------------|
| APPLICATION | MODEL NUMBER | MAXIMUM DOOR OPENING | (A) 3 HOUR |
| SINGLE DOORS Rim type | F5000EO36 | 3'0" X 7'0" | ✓ |
| PAIRS OF DOORS Two surface mounted standard vertical rod type | F5000V3684 X F5000V3684 | 6'0" X 7'2" | ✓ |
| | F5000V3684 X F5000V3684 | 6'0" X 7'2" | ✓ |
| a) Swinging in same direction b) Swinging in opposite direction (double egress) | | | |
| PAIRS OF DOORS Two rim type with Mullion | F5000EO36 | 6'0" X 7'2" | ✓ |

All fire rated exit devices in all applications, are also labeled for (B) 1½ hour, (C) ¾ hour, (D) 1 hour, (E)¾ hour.
All fire exit hardware meet UL10C and UBC 7-2-1997 codes.

HOW TO ORDER INFORMATION

Exit device model number

Panic grade

5000 E036 Rim type 36" door
5000 V3684 Vertical rod type 36" x 84"

Fire grade

F5000 E036 Rim type 36" door
F5000 V3684 Vertical rod type 36" x 84"

- 1] Specify exit device model number according to size of door.
- 2] Specify trim selection.
- 3] For vertical rod devices specify LHR (Left Hand Reverse) or RHR (Right Hand Reverse) for convenience easily field reversible, otherwise shipped as LHR.
- 4] Specify finish:
Alum - Powder coated to match US26D
US32D Stainless Steel
- 5] On thru bolt applications, fire rated vertical rod devices are packed with thru bolts as standard feature. Thru bolts are also available for other devices. To order thru bolts add "SBN" to trim pack.
When ordering separately use following part#
Cal-Royal part # 357 — Thru bolts for rim devices, 6 PCs / pack.
Cal-Royal part # 369 — Thru bolts for vertical rod devices, 14 PCs / pack.
Ordering example: 5000E036 ALUM X 8000L 26D
5000V 3684 32D X CLU5000L 26D

5000 & F5000 Rim Type Panic And Fire Exit Devices 5000V & F5000 Vertical Rod Panic And Fire Exit Devices ANSI A156.3 Grade 2

Selector Chart

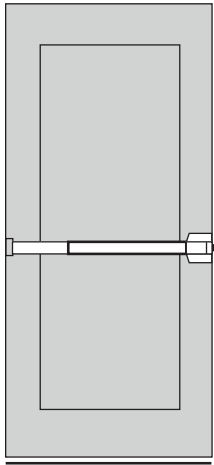
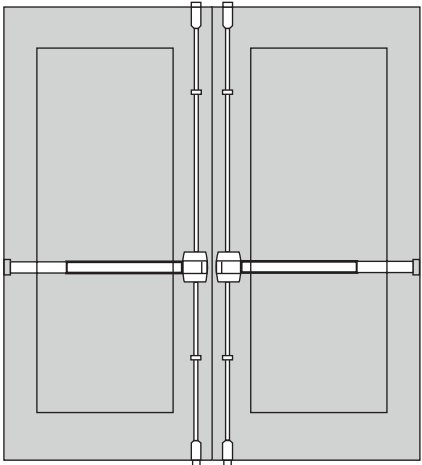
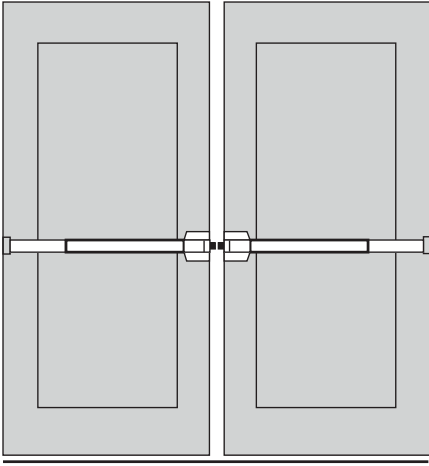
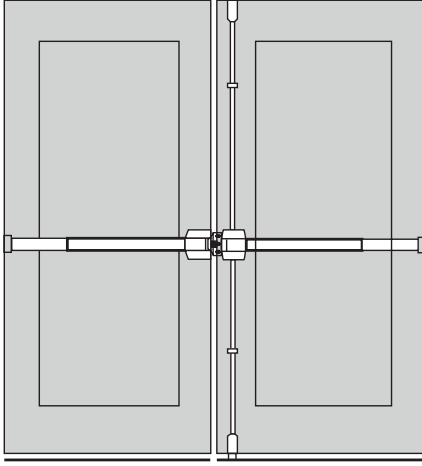
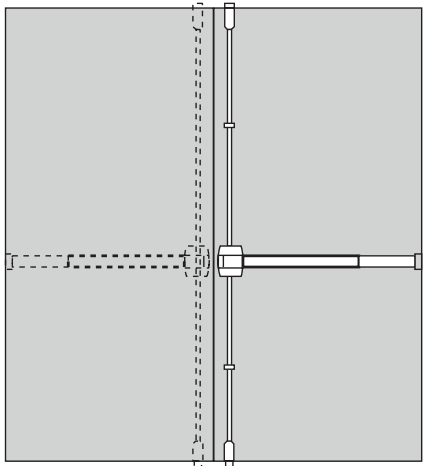
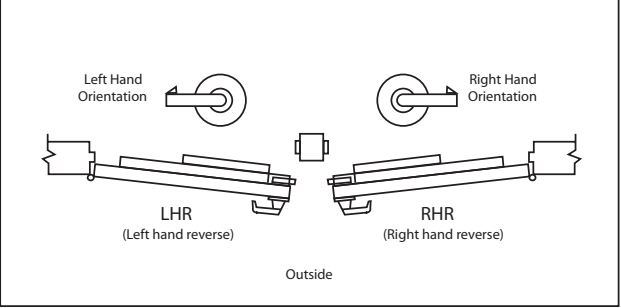
| | |
|--|---|
| <p style="text-align: center;">SINGLE DOOR</p>  <p>Vertical rod type or Rim type Surface applied 2 point lock. Surface application.</p> | <p style="text-align: center;">PAIRS OF DOORS WITHOUT MULLION</p>  <p>2 Vertical rod type Surface applied 2 point locking both doors. Each door active same direction. Do not use with overlapping astragal.</p> |
| <p style="text-align: center;">PAIRS OF DOORS WITH MULLION</p>  <p>2 Rim type with mullion Two independent active doors with full double door openings when required. Same direction.</p> | <p style="text-align: center;">PAIRS OF DOORS WITHOUT MULLION</p>  <p>1 Vertical rod and 1 rim type Both devices are surface applied. A coordinator and overlapping strike is recommended.</p> |
| <p style="text-align: center;">PAIRS OF DOORS WITHOUT MULLION</p>  <p>2 Vertical rod type Double egress surface applied. 2 point locking both doors opposite directions.</p> | <p style="text-align: center;">HANDING</p>  <p style="text-align: center;">Left Hand Orientation Right Hand Orientation</p> <p style="text-align: center;">LHR (Left hand reverse) RHR (Right hand reverse)</p> <p style="text-align: center;">Outside</p> |

CAL-ROYAL PRODUCTS, INC.

6605 FLOTILLA ST, COMMERCE, CA 90040 U.S.A.

TEL: (323) 888-6601 FAX: (323) 888-6699

Website: cal-royal.com • Email: sales@cal-royal.com

Ver. 1.0, Rev. 6/11
© 2011 CAL-ROYAL