



CAL-ROYAL PRODUCTS, INC.

ID-60 ONE-SIDED DEAD BOLT SERIES AND ANSI GRADE 3

DEADBOLT LOCK DOOR PREPARATION for 2-3/4" Backset

- ▷ DOOR THICKNESS : 1 3/8" (35mm) TO 1 3/4" (45mm)
- ▷ DOOR TYPE : WOOD OR STEEL, FLAT OR BEVELED
- ▷ FACEPLATE : STANDARD - 1 "
- ▷ BACKSET : 2 3/4" (70mm)

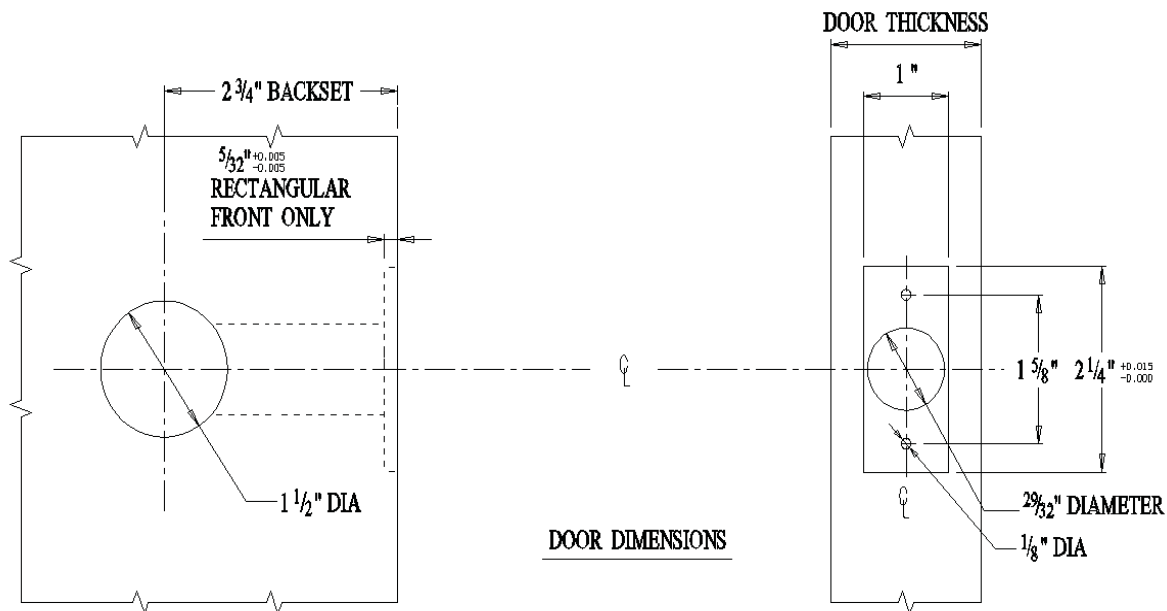
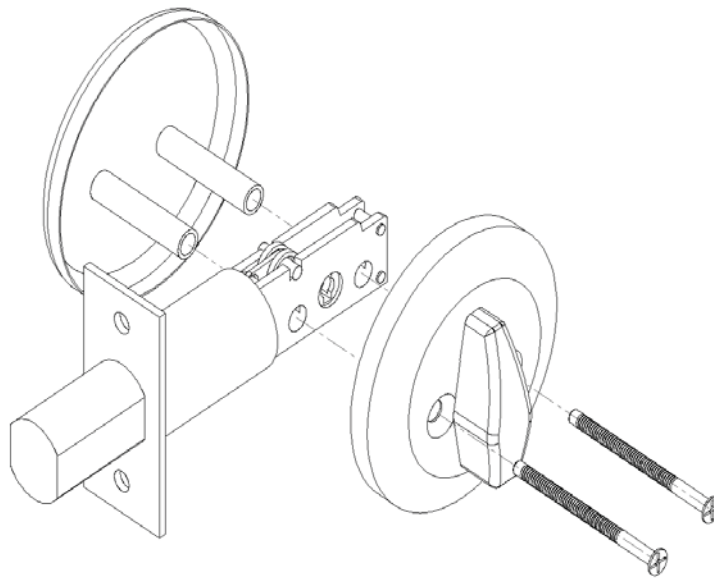

Dimensions shown in parentheses () are in millimeters

