

CAL-ROYAL CR-CODE-007 Access Control Trim for 9800/9900 Series Exit Device

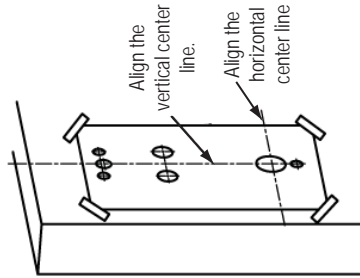

1. Align the center line of the template with the center line of the panic device (as illustrated). Tape it on the door, then drill holes wherever indicated.



2. The lock is supplied with a backplate designed for the 9800/9900 Series exit device.

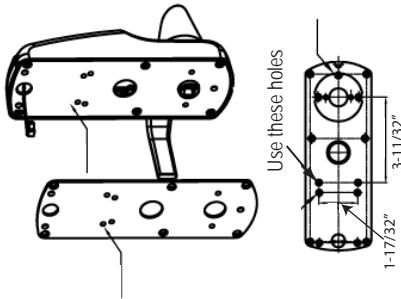

3. Fit backplate to lock and familiarize yourself with position of spindle and fixings between the backplate and panic device.

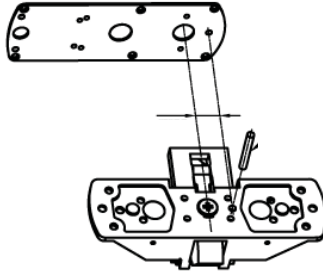

4. See illustrated sequence below.

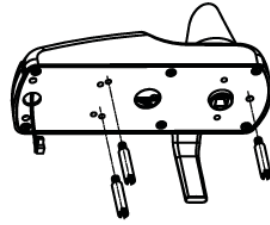

4.1 Fit (3) fixing posts to backplate.

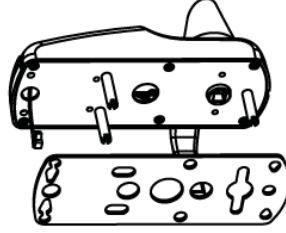

4.2 Fit gasket to backplate.

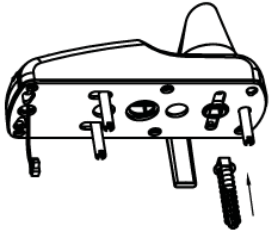

4.3 Insert Spindle.

5. Hold front plate to door, ensuring cable passes through door.

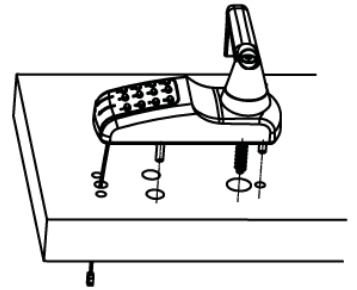

6. Hold panic device to door, aligning holes and spindle. Secure to front plate with fixing screws.

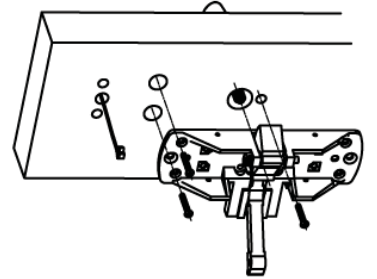

7. Secure battery holder to door with fixing through bolts onto the front plate.

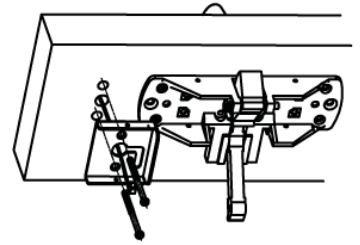

8. Connect battery pack and feed excess wire into door. Enter a valid code and check operation of panic latch via the lock lever.

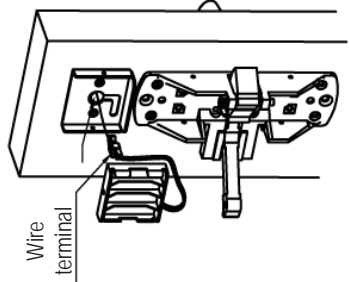

9. Fit the battery cover securing with screws.

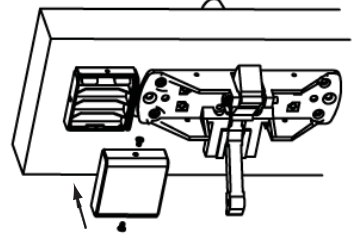

10. Attach the panic device cover. Secure it with 4 set screws.

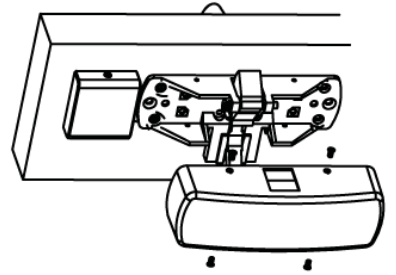



CR-CODE-007

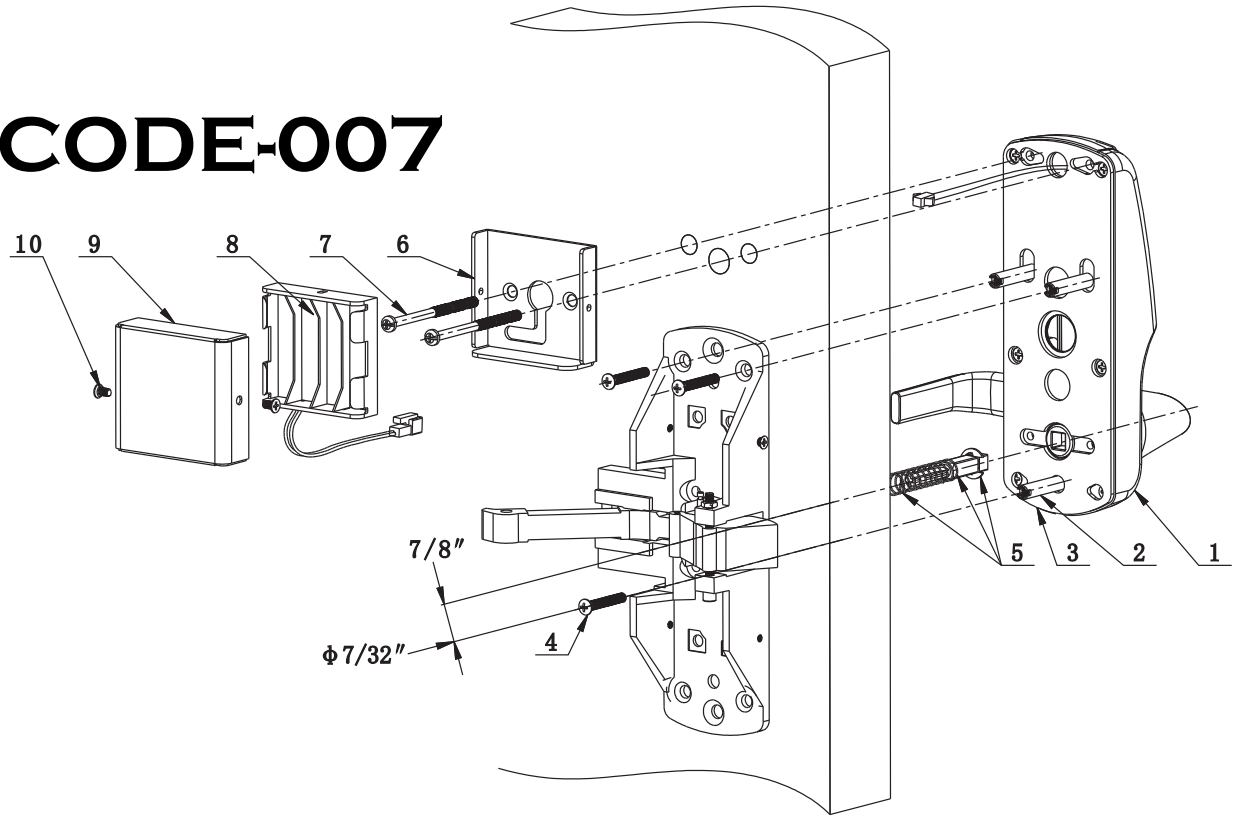
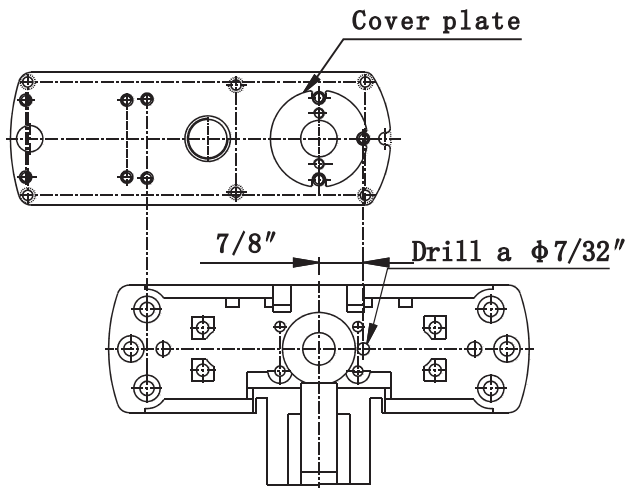

Complementary Installation Instruction:

1. Factory will provide a backplate designed for Cal-Royal 9800/9900 panic device.
2. For already existing/installed 9800/9900 panic device, drill a $\phi 7/32"$ hole (as illustrated) 7/8" from the center of the spindle hole. Ensure it aligns with all screw holes. (Note: Cal-Royal 9800/9900 can be ordered with pre-drilled holes prior to delivery)
3. Tape template on the door and drill holes wherever indicated.
4. Insert the fixing posts ② onto the bottom screw holes of front plate ①. Then fit self-adhesive gasket ③ onto the bottom plate of front plate ①.
5. Fit the whole front plate ① with ② and ③ to the holes on the door, and the battery wire terminal through the hole as indicated.
6. Fit the whole spindle set ⑤ from the rear sidespindle hole to the front plate ① (coded side).
7. Place panic device through insert spindle cross set at point ⑤, then at point ④ insert fixing screws onto fixing post at point ②.
8. Tighten the bottom plate ⑥ of battery holder with fixing bolts ⑦. Then screw the fixing bolts ⑦ tightly into M5 hole on the front plate ①. Please note: The battery cable goes through the bottom hole of the bottom plate ⑥.
9. Place the batteries, connect the battery clip connecting cables with the connecting cables from the CR-CODE-007 lock. Place the wires into the door and place battery clip onto bottom plate of battery holder ⑧.
10. Fit the battery cover ⑨, then secure the screw tightly ⑩.

TEMPLATE FOR RIM EXIT DEVICE

FOR LOCATION OF 9800/9900 SERIES RIM DEVICE
USING CRCODE-007 ACCESS CONTROL TRIM

