

BARRINGTON BA Series

STANDARD DUTY CYLINDRICAL LOCKSETS

ANSI A156.2 Series 4000 Grade 2

Optional Interchangeable Core for **Best, Falcon and Arrow**

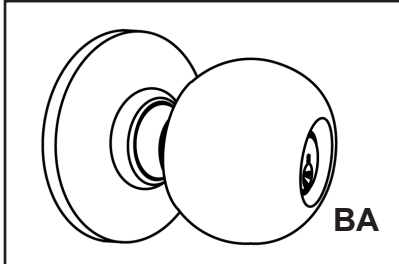

LIFETIME WARRANTY

MEETS
The Buy American Act

STOCK ITEM PRICES IN BOLD
NON-STOCK FINISHES AND DESIGNS AVAILABLE WITH FACTORY LEAD TIME AND SUBJECT TO MINIMUM ORDER.

Made in Korea				
FUNCTION	ANSI	ITEM #	FINISH	PCS / MC
Entrance *****KA/4	F109	BA00	US32D, 10B, 3, 10, 4, 26	20
		● ICBA00		
Combination Entrance and Single Cylinder Deadbolt -- KA / 2 packed together	---	BA00 / T220		
		BA03		
Classroom	F84	BA03		
		● ICBA03		
Storeroom	F86	BA05		
		● ICBA05		
Communicating	F80	BA04		
Institution	F87	BA09		
Privacy	F76	BA20		
Passage	F75	BA30		
Exit	F89	BA50		
Single Dummy	----	BA40	50	

Made in Taiwan				
FUNCTION	ANSI	ITEM #	FINISH	PCS / MC
Entrance *****KA / 4	F109	TBA00	US32D, 10B, 3, 10, 4, 26, 19	20
		● ICTBA00		
Classroom	F84	TBA03		
		● ICTBA03		
Storeroom	F86	TBA05		
		● ICTBA05		
Storelock	F91	TBA02		
Communicating	F80	TBA04		
Institution	F87	TBA09		
Privacy	F76	TBA20		
Passage	F75	TBA30		
Exit	F89	TBA50		
Single Dummy	----	TBA40		

BARRINGTON BA Series
STANDARD DUTY CYLINDRICAL LOCKSETS
ANSI A156.2 Series 4000 Grade 2

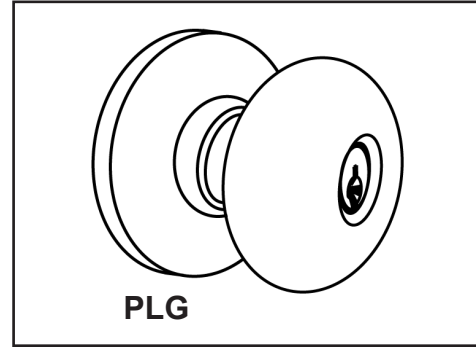
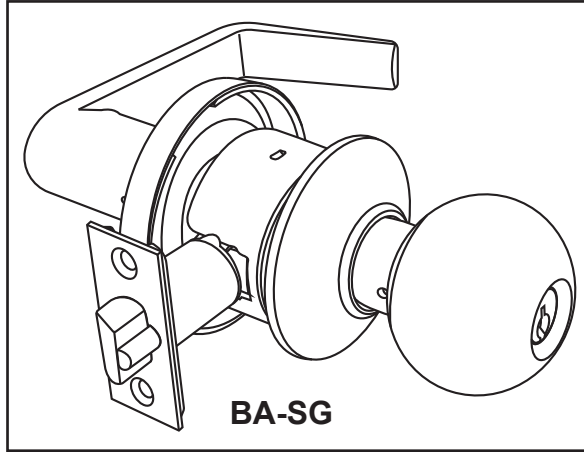

STOCK ITEM PRICES IN BOLD
NON-STOCK FINISHES AND DESIGNS AVAILABLE WITH FACTORY LEAD TIME AND SUBJECT TO MINIMUM ORDER.

FUNCTION	ANSI	ITEM #	FINISH			PCS / MC
			US32D	US3, 10B	US4, 10	
Storeroom	F86	BA-SG05	US32D	US3, 10B	US4, 10	10
Entrance *****KA / 4	F109	PLG00	US32D, 3, 10B, 4, 10			20
Classroom	F84	PLG03				
Storeroom	F86	PLG05				
Storelock	F91	PLG02				
Communicating	F80	PLG04				
Institution	F87	PLG09				
Privacy	F76	PLG20				
Passage	F75	PLG30				
Exit	F89	PLG50				
Single Dummy	----	PLG40				50

► **BA / PLG PACKAGING INCLUDES**

- Standard "C", 6-pin cylinder
- UL Listed 2 3/4" Backset
- 2 1/4" x 1 1/8" faceplate and ASA Strike

► **BA-SG PACKAGING INCLUDES**

- Standard "C", 6-pin cylinder
- 2 3/8" Backset
- 2 1/4" x 1" Faceplate and T-Strike

► **KEYWAYS**







6-pin solid brass "C" keyway standard. Optional: Schlage E, Schlage C-K, Russwin D1-2-3-4, Corbin 59 / 60, Corbin-Russwin L4, Sargent LA-LB-LC, Falcon / Weiser E, Arrow A, Yale 8, Yale GA and Kwikset. Can also accept Medeco, Assa, Kaba and **Cal-Royal HSK** High Security Cylinders.

► **TACTILE / LEAD LINING**

- Lead Lining Part # **LEAD**
- Tactile Part # **TAC**

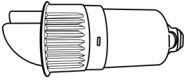
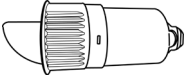
► ADDITIONAL PARTS & CHARGES FOR BARRINGTON AND POLYGON SERIES

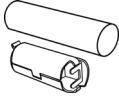
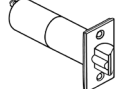
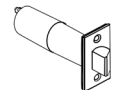
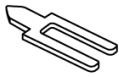
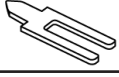
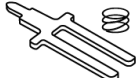
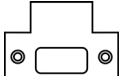
Backsets: UL listed 2 3/8", (2 1/4" x 1") faceplate, **NO EXTRA CHARGE** if ordered with lock only.

◆◆◆ STANDARD DISCOUNT ONLY ◆◆◆			
ILLUSTRATION	ITEM #	DESCRIPTION	FINISH
	ULSLD238	BA Series UL-listed Dead Latch 2 3/8" PLG Series UL-listed Dead Latch 2 3/8" 2 1/4" x 1" Faceplate	US3, 32D, 10B
	ULSLS238	BA Series UL-listed Spring Latch 2 3/8" PLG Series UL-listed Spring Latch 2 3/8" 2 1/4" x 1" Faceplate	
	SLDRI-1	2 3/4" Entrance, Drive-in Latch bolt for G2 Lockset	ZINC
	SLDRI-4	2 3/8" Entrance, Drive-in Latch bolt for G2 Lockset	
	SLDRI-2	2 3/4" Privacy / Passage, Drive-in Latch bolt for G2 Lockset	
	SLDRI-5	2 3/8" Privacy / Passage, Drive-in Latch bolt for G2 Lockset	
EXTRA UL LISTED BACKSET			
	ULSLD234	Dead Latch 2 3/4" 2 1/4" x 1 1/8" Faceplate	US3, 26D, 10B, 10, 26
	ULSLS234	Spring Latch 2 3/4" 2 1/4" x 1 1/8" Faceplate	
3 3/4", 5" UL LISTED BACKSET			
	SL5	5" UL listed Extension Link	----
	SLD334	Barrington & Polygon Series 3 3/4" Dead latch 2 1/4" x 1 1/8" Faceplate	US3, 26D, 10B
	SLS334	Barrington & Polygon Series 3 3/4" Spring Latch 2 1/4" x 1 1/8" Faceplate	
TAIL PIECE			
	ICTP-03	6-pin Tail Piece for ICBA Series	----
	ICTP-04	7 Pin Tail Piece for ICBA Series	
	ICTP-08	Tail Piece for ICTBA Only	
STRIKES			
	TS	T-Strike	US3, 26D, 10B, 10, 15, 26, 4
	FLS	Full Lip Strike	