

Installation Instructions CLCR05 Locks

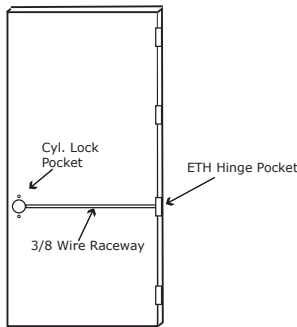

Cal Royal Lock modified by Command Access Technologies

STEP 1: The door must be machined with a 3/8" wire raceway, cylindrical lock pocket & prepped for a energy transfer hinge. **Make sure the cylindrical pocket is free of debris.**



STEP 2: Run the wires from the ETH hinge through the 3/8" raceway starting at the ETH hinge & exiting into the lock pocket.

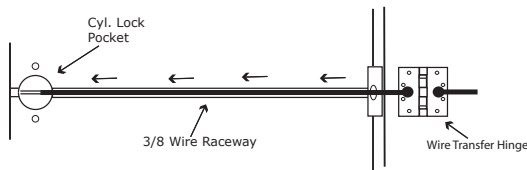

STEP 3: Screw the ETH hinge to the door. At this time **DO NOT** connect the hinge wires on the jamb side to the wires coming from the power supply.

STEP 4: Connect the wires exiting the lock pocket to the Bridge Rectifier (included).

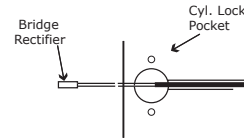

STEP 5: Connect the Bridge Rectifier to the plug exiting the cylindrical chassis.

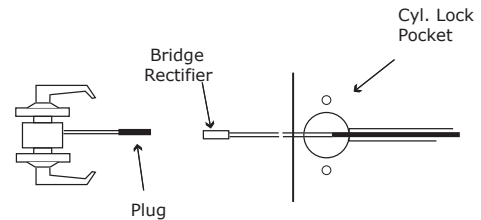

STEP 6: Carefully slip the connected cylindrical lock chassis into the lock pocket paying close attention not to pinch any wires.

STEP 7: Mount the cylindrical lock per manufacturer's instructions.

STEP 8: Connect the wires from the power supply at the ETH hinge on the jamb side. Connect the hinge to the jamb.

LEGEND OF TERMS

EU: (Fail Secure) When power is applied, the outside trim will unlock. When power is removed, the outside trim is locked.

EL: (Fail Safe) When power is applied, the outside trim will lock. When power is removed, the outside trim is unlocked.

REX: (Request to Exit Switch) Monitors the inside handle.

ELECTRICAL SPECIFICATIONS

SOLENOIDS:

VOLTS	CURRENT	COIL RESISTANCE
24VAC/DC	150mA	159 Ohms +/- 10%
12VAC/DC	250mA	49 Ohms +/- 10%

SWITCHES: .25A 175VAC/DC

REX: White - Common (C)
Blue - Normally Open (NO)
Black - Normally Closed (NC)

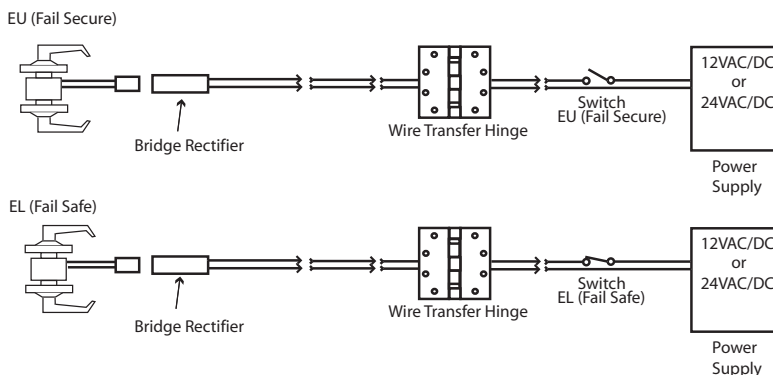

Template for CLCR05 Cylindrical Locks

