

**SQ300 SERIES**  
**CONTEMPORARY SQUARE**  
**HEAVY DUTY DEADBOLTS**  
FOR COMMERCIAL AND RESIDENTIAL APPLICATIONS  
ANSI A156.5, GRADE 2



**LIFETIME WARRANTY**

**MEETS**  
*The Buy American Act*

Meets ADA requirements  
Specially designed for  
Barrier Free Application  
Conforms with BHMA / ANSI A156.5  
Series 4000, Grade 2 Requirements,  
Exceeds 20,000 Cycles

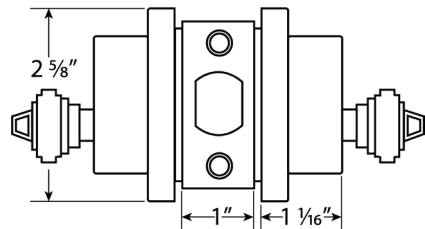
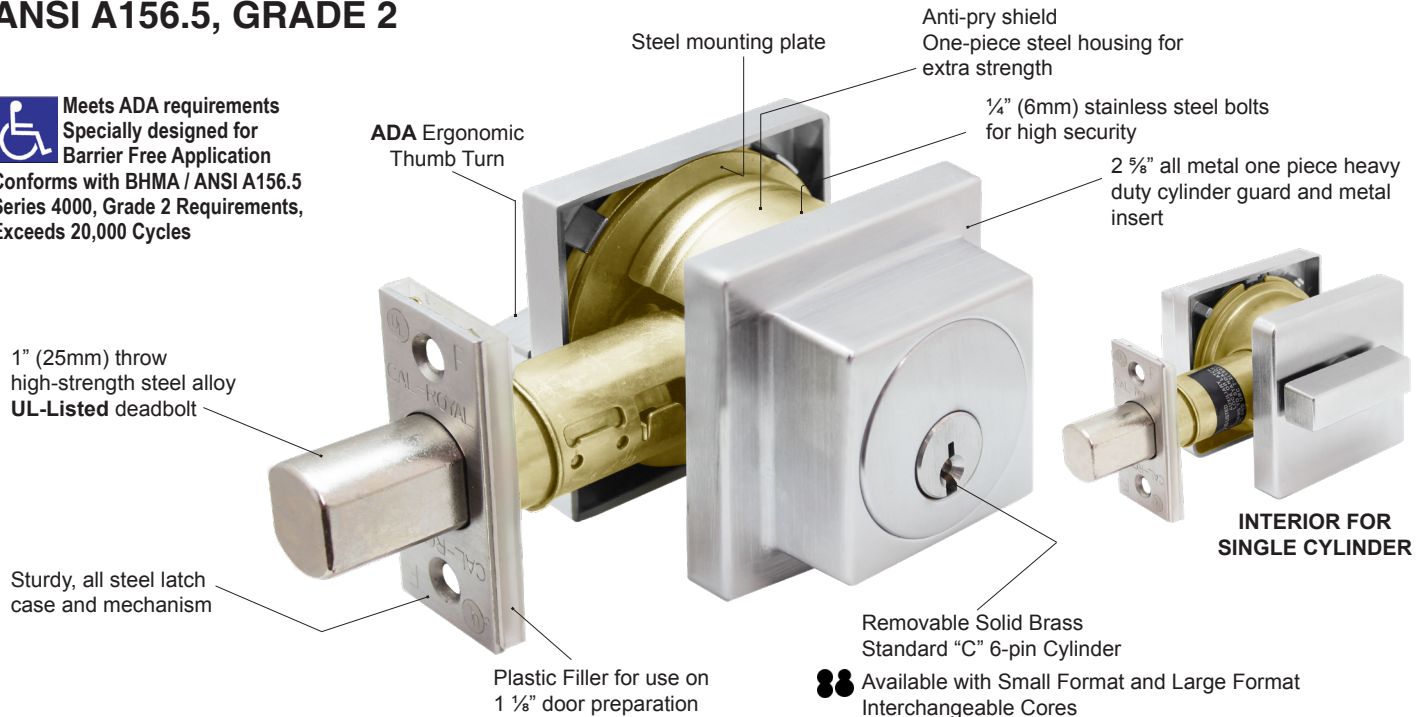

**SQ-330 DOUBLE CYLINDER**

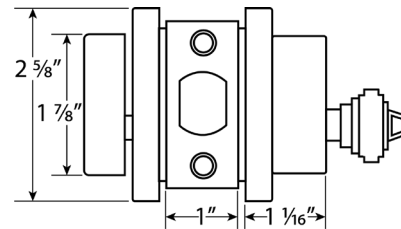

**SQ-220 SINGLE CYLINDER**

**SPECIFICATIONS**

**TRIM**

Wrought Brass or Zinc

**DOOR RANGES**

Adjustable 1 3/8" (35mm) to 1 3/4" (45mm) door thickness.

**BACKSET**

Adjustable UL Listed 3 Hour Fire Rating  
2 3/8" or 2 3/4" latch bolt.

**DEADBOLT FACEPLATE**

Standard 2 1/4" x 1" packed with 1/8" plastic filler to convert 1" face plate to 1 1/8" wide door preparations.

**BORE DIAMETER**

1" for latch, 2 1/8" for lock housing.

**STRIKE**

1 1/8" x 2 3/4" Square Corner. Extra security 1" throw bolt with 1/4" free spinning anti-cut through pin. 2 pcs x 3" screws with wood frame reinforcer greatly strengthens door frames.

**KEYWAYS**

6 pin solid brass "C" keyway standard. Schlage E, Schlage C-K, Russwin D1-2-3-4, Corbin 59 / 60, Corbin-Russwin L4, Sargent LA-LB-LC, Falcon / Weiser E, Arrow A, Yale 8, Yale GA and Kwikset. Can also accept Medeco, Assa, Kaba and Cal-Royal (HSK) High Security Cylinders.

**INTERCHANGEABLE CORE**

- Interchangeable Core locks will accept compatible 6 or 7-Pin cores with BEST, FALCON and ARROW and
- Schlage Large Format Interchangeable Core.

# SQ300 SERIES FINISHES AND FUNCTIONS



FINISHES AVAILABLE		
BHMA SYMBOL	US CODE	DESCRIPTION
---	US1	Black
606	US4	Satin Brass
613	US10B	Oil Rubbed Bronze
619	US15	Satin Nickel
626	US26D	Satin Chrome

Refer to price list for stock finishes and functions

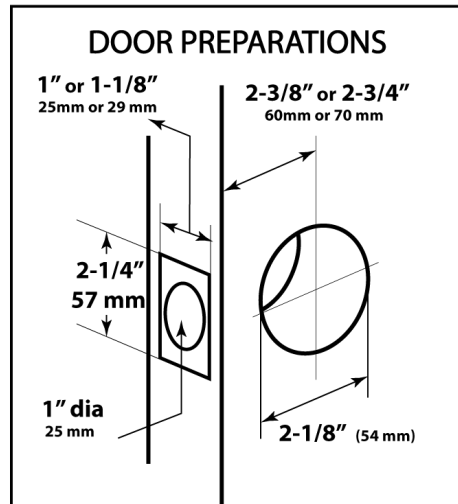

**LIFETIME WARRANTY**

**MEETS**  
*The Buy American Act*

- SQ-220
  - ICSQ-220
  - ICSCSQ-220
- ANSI E0152

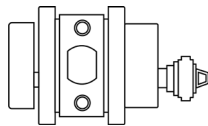

### Heavy Duty Single Cylinder Deadbolt

Deadbolt thrown or retracted by key from outside or by inside turn unit. Bolt automatically deadlocks when fully thrown.

- SQ-330
  - ICSQ-330
  - ICSCSQ-330
- ANSI E0142

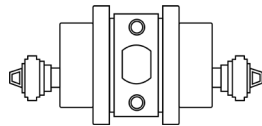

### Heavy Duty Double Cylinder Deadbolt

Deadbolt thrown or retracted by key from either side. Bolt automatically deadlocks when fully thrown.

- SQ-600
  - ICSQ-600
  - ICSCSQ-600
- ANSI E0172

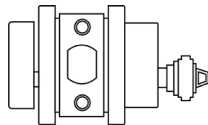

### Classroom Deadbolt Lock

Deadbolt thrown or retracted by key from outside. Inside turn unit will retract bolt only. Bolt automatically deadlocks when fully thrown.

- SQ-700
  - ICSQ-700
  - ICSCSQ-700
- ANSI E1161

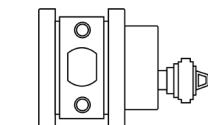

### One Way Dead Bolt WITH INTERNAL PLATE

Deadbolt thrown or retracted by key only. Bolt automatically deadlocks when fully thrown. Blank plate inside (exposed screws).

SQ-363

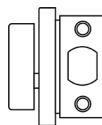

### One Sided Dead Bolt

Deadbolt thrown or retracted by turn unit only. No outside trim. Bore halfway through door for installation visible from one side of door only.

SQ-365

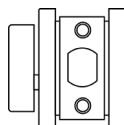

### One Sided Dead Bolt WITH EXTERNAL PLATE

Deadbolt thrown or retracted by turn unit only. Blank plate is on external trim to be used on bore holes 2 1/8" wide.

## OTHER FUNCTIONS NOT LISTED ARE AVAILABLE UPON REQUEST

- "IC" Indicates functions available with Interchangeable Core compatible with 6 or 7-Pin cores by Best, Falcon and Arrow.
- "ICSC" Indicates deadbolts that are available with Schlage Large Format Interchangeable Core