

- Available with Interchangeable Core for Best, Falcon & Arrow
- Available with Interchangeable Core for Schlage Full Size Format OEM Cylinders

T220 STANDARD DUTY DEADBOLTS
GL220 STANDARD DUTY GATE LATCHES
FOR LIGHT COMMERCIAL AND RESIDENTIAL APPLICATIONS

MEETS
The Buy American Act

Conforms with ANSI A156.5
Series 4000, Grade 2
Exceeds 400,000 cycles

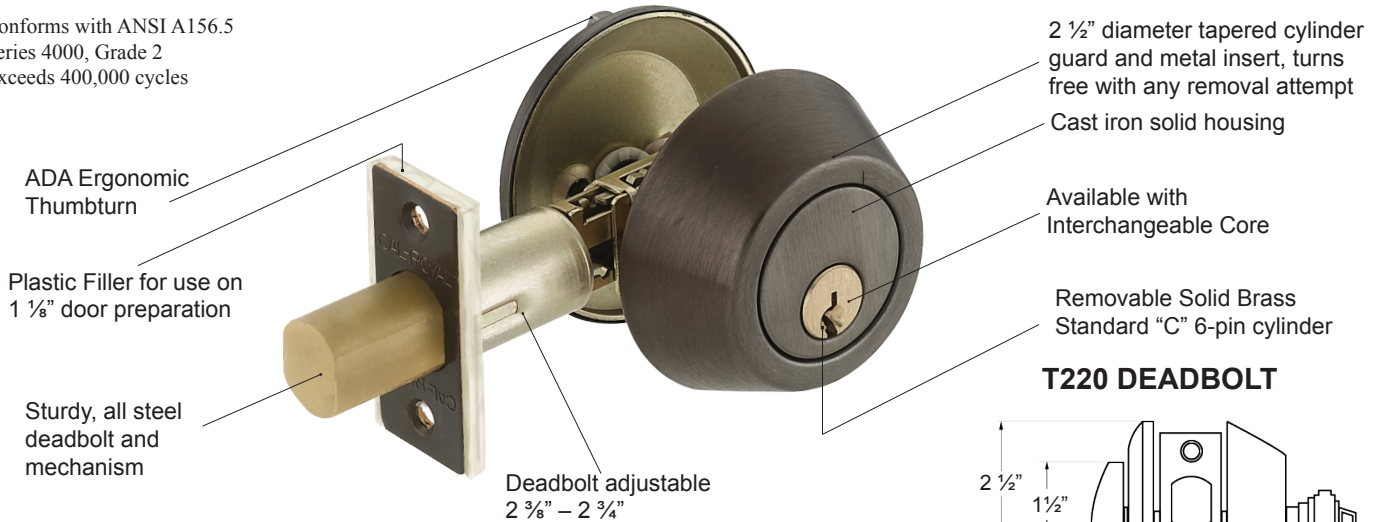

T220 DEADBOLT

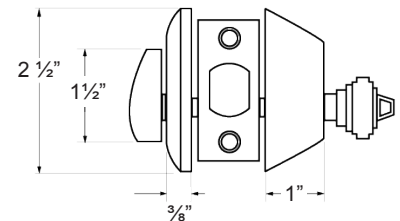

GL330 GATE LATCH
DOUBLE CYLINDER



GL220 GATE LATCH
SINGLE CYLINDER



- SINGL238** - 2 3/8" backset gate latch and for single cylinder deadbolt
- SINGL234** - 2 3/4" backset gate latch and for single cylinder deadbolt
- GL238** - 2 3/8" backset gate latch and for double cylinder deadbolt
- GL234** - 2 3/4" backset gate latch and for double cylinder deadbolt

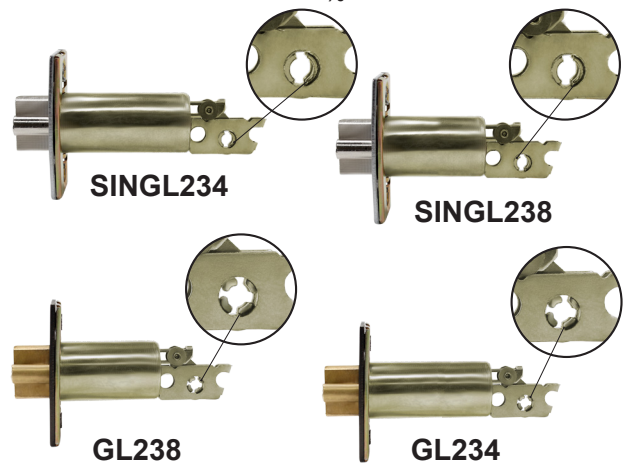

SPECIFICATIONS

TRIM

Wrought Brass or Stainless Steel.

DOOR RANGES

Adjustable 1 3/8" (35mm) to 1 3/4" (45mm) door thickness.

BACKSET

Adjustable 2 3/8" or 2 3/4" for T220 and T330.
For GL220 and GL330 specify backset.

DEADBOLT FACEPLATE

Latch bolt: Standard 2 1/4" x 1" packed with 1/8" plastic filler to convert 1" face plate to 1 1/8" wide door preparations.

BORE DIAMETER

1" for latch, 1 1/2" or 2 1/8" for lock housing.

STRIKE

1 1/8" X 2 3/4" square corner.

● **INTERCHANGEABLE CORE**

Interchangeable Core locks will accept compatible 6 or 7 pin cores with BEST, FALCON and ARROW.

●

Interchangeable Core locks will also accept SCHLAGE full size format OEM interchangeable core cylinders and compatible Schlage 6-pin Interchangeable Core. Interchangeable Core offered by Cal-Royal Products, Inc.

T220 / GL220 SERIES FINISHES AND FUNCTIONS



FINISHES AVAILABLE		
BHMA SYMBOL	US CODE	DESCRIPTION
605	US3	Polished Brass
606	US4	Satin Brass
609	US5	Antique Brass
612	US10	Satin Bronze
613	US10BE	Dark Oxidized Satin Bronze, Equivalent
619	US15	Satin Nickel
625	US26	Polished Chrome
626	US26D	Satin Chrome

Refer to price list for stock finishes and functions

DOOR PREPARATION

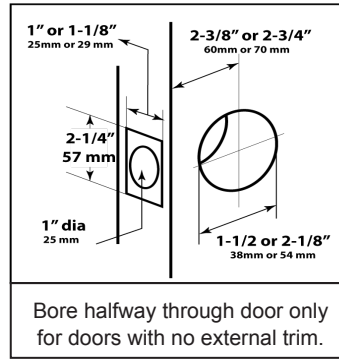

MEETS
The Buy American Act

T220
ICT220
SCICT220
ANSI E0153

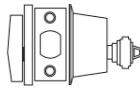

Single Cylinder Deadbolt
Dead locking latch bolt retracted by key from outside or by thumb turn on inside. Adjustable 2 3/8" or 2 3/4" backset.

T330
ICT330
SCICT330
ANSI E0143

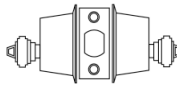

Double Cylinder Deadbolt
Dead locking deadbolt retracted by key from either side. Adjustable 2 3/8" or 2 3/4" backset.

ID58



One Sided Deadbolt
Deadbolt thrown or retracted by turn unit only. No outside trim. Bore halfway through door for installation visible from one side of door only.

ID60



One Sided Deadbolt
Deadbolt thrown or retracted by turn unit only. Blank plate is on external trim to be used on bore holes 1 5/8" and 2 1/8" wide.

GL220
ICGL220
ANSI E0153

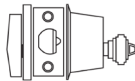

Single Cylinder Gate Latch
Dead locking latch bolt retracted by key from outside or by thumb turn on inside. Otherwise always locked (2 3/8" backset)

GL220234
ICGL220234
ANSI E0142

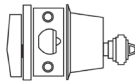

Single Cylinder Gate Latch
Dead locking latch bolt retracted by key from outside or by thumb turn on inside. Otherwise always locked (2 3/4" backset)

GL330
ICGL330
ANSI E0143

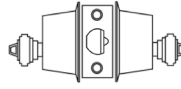

Double Cylinder Gate Latch
Dead locking latch bolt retracted by key from either side. Otherwise, always locked. (2 3/8" backset)

GL330234
ICGL330234
ANSI E0142

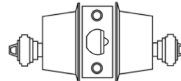

Double Cylinder Gate Latch
Dead locking latch bolt retracted by key from either side. Otherwise, always locked. (2 3/4" backset)

GL58



One Sided Latch Bolt
Dead latch retracted by thumb turn, no outside trim. Visible from one side of door only. Otherwise always locked.

GL60



One Sided Latch Bolt
Dead latch retracted by thumb turn unit. Blank plate on external trim to be used on bore holes 1 5/8" and 2 1/8" diameter. Otherwise, always locked.

GL58234



One Sided Latch Bolt
Dead latch retracted by thumb turn, no outside trim. Visible from one side of door only. Otherwise always locked.

GL60234



One Sided Latch Bolt
Dead latch retracted by turn unit. Blank plate on external trim to be used on bore holes 1 5/8" and 2 1/8" diameter. Otherwise, always locked.

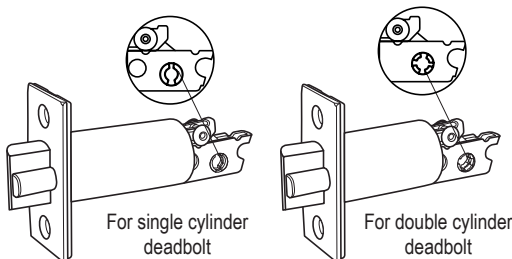

For single cylinder deadbolt

For double cylinder deadbolt

ADDITIONAL PARTS

SINGL238	2 3/8" backset gate latch (1 1/8" x 2 1/4") for single cylinder deadbolt
SINGL234	2 3/4" backset gate latch (1 1/8" x 2 1/4") for single cylinder deadbolt
GL238	2 3/8" backset gate latch (1 1/8" x 2 1/4") for double cylinder deadbolt
GL234	2 3/4" backset gate latch (1 1/8" x 2 1/4") for double cylinder deadbolt

- "IC" Indicates function available with BEST, FALCON & ARROW Interchangeable Core.
- "SCIC" Indicates function available with SCHLAGE full size format Interchangeable Core.

OTHER FUNCTIONS NOT LISTED ARE AVAILABLE UPON REQUEST

HOLD BACK FEATURE ON DEADBOLT WITH GATE LATCH NOT AVAILABLE