

**TABLE OF CONTENTS**

**I. GRADE 1**

**MORTISE**

**ESCUTCHEON**

NM Series..... L5-L10  
 WI Series (NM Series)..... L11-L13  
 WI Series (SC Series)..... L18-L19

**SECTIONAL**

NM Series..... L1-L4  
 SC Series..... L16-L17

**DEADBOLT**

NM Series..... L14  
 SC Series..... L20

**ACCESSORIES**

NM Series..... L15  
 SC Series..... L21

**HOSPITAL**

HL Series..... L23

**LIGATURE RESISTANT**

LG Series..... L24

**TUBULAR**

HOSPP Series..... L26

**CYLINDRICAL**

Genesys Series..... L28  
 Calypso Series..... L36  
 Omega GRB Series..... L38

**DEADBOLTS**

CRB800 Series..... L67

**II. GRADE 2**

**MECHANICAL**

CRCODE200 Series..... L44

**CYLINDRICAL**

Pioneer SL & CSL Series..... L45  
 Commander Com (Clutch)..... L49  
 Explorer XP & CXP Series..... L50  
 Challenger Series..... L54  
 Tuscany Series..... L42  
 Barrington BA Series..... L58

**INTERCONNECTED**

HIL Series List..... L62  
 JHIL Series..... L63

**DEADBOLT**

T300 Series..... L69  
 T400 Series..... L71  
 CB160 Series..... L73  
 Standard Duty Deadbolts Series..... L75  
 Gate Latch Dead Latches Series..... L77

**III. GRADE 3**

**CYLINDRICAL**

Columbus Series..... L61  
 Epic Series..... L64

**III. GRADE 3**

**DEADBOLT**

LSD Series..... L79  
 IND84 Indicator Deadbolts Series..... L80  
 Chelsie Series..... L88

**TUBULAR**

Legacy Series..... L98  
 Clipper Series..... L99  
 Contemporary Series..... L85  
 Summit Series..... L86  
 Chelsie Series..... L83  
 Vanguard Series..... L91  
 Heritage Series..... L97  
 Ashley Series..... L81  
 Italia Series..... L92

**HANDLESETS**

Chelsie Series..... L87

**IV. KEYS & KEYING**

**REPLACEMENT CYLINDERS**

Key-in-Knob-Lever Cylinders..... L102  
 Rim Cylinders..... L103  
 Mortise Cylinders..... L102  
 Mortise and Rim Cylinders..... L104  
 Mortise Cylinder Accessories..... L103  
 Mortise Cylinder Cams..... L103  
 Small Format IC Cylinders..... L105  
 Large Format IC Cylinders..... L106

**RESTRICTED CYLINDERS**

Key-in-Knob-Lever Cylinders..... L107  
 Small Format IC Cylinders..... L107  
 Mortise Cylinders..... L107  
 Single Cylinder Deadbolt Kits..... L107  
 Double Cylinder Deadbolt Kits..... L107  
 Mortise and Rim Cylinder Kits..... L107  
 ..... L107

**HIGH SECURITY KEY (HSK) SYSTEM**

Key-in-Knob-Lever Cylinders..... L108  
 Mortise-Rim Combo Cylinder..... L108  
 Small Format Interchangeable Core Cylinders..... L108  
 Large Format Interchangeable Core Cylinders..... L108  
 IC Housing..... L108  
 Accessories..... L109

**CRP COMBI CYLINDER PROGRAM**

Key-in-Knob-Lever Cylinders..... L113  
 Small Format IC Cylinders..... L113  
 Mortise Cylinders..... L113  
 Large Format Interchangeable Cores..... L113  
 European Profile Cylinders..... L113  
 CRP Combi Pinning Kits..... L114

**COMMERCIAL KEYING** ..... L115

**RESIDENTIAL KEYING** ..... L116



## NM Series

HEAVY DUTY, GRADE 1 MORTISE LOCKSET

**••** Optional Interchangeable Core Small Format (Best, Falcon and Arrow) or Large Format (Schlage)

 <small>3 HOUR FIRE RATED UL10C, UBC7-2-1997</small>	<b>LIFETIME WARRANTY</b>	<b>BHMA</b> <b>CERTIFIED</b> <small>Be Safe. Be Secure. Look for the Mark.</small>	<b>MEETS</b> <i>The Buy American Act</i>	 <small>HURRICANE APPROVED HARDWARE FLORIDA BUILDING CODE: FL13922-R1 ASTM E1686/E1996 ASTM E530 TAS 201, 202, 203 UL10B UL19C</small>
---	--------------------------	--	---	---

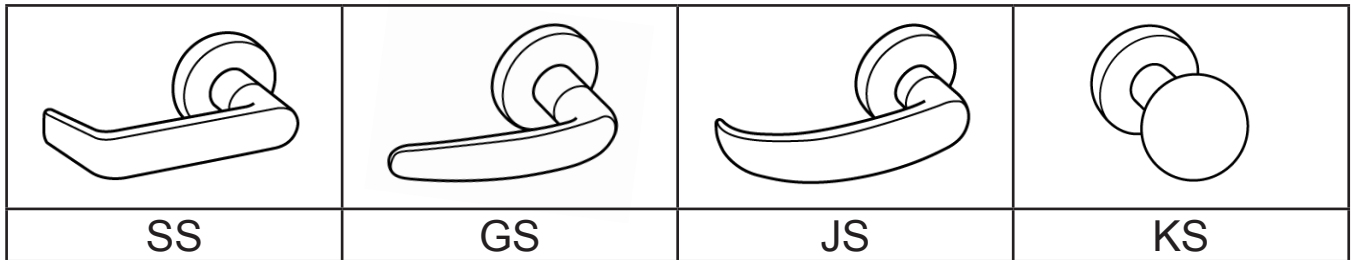

**ALL ITEMS BELOW AVAILABLE WITH FACTORY LEAD TIME AND SUBJECT TO MINIMUM ORDER QUANTITY**

### SS, GS, JS, AND KS SECTIONAL TRIM ONLY

FUNCTIONS	ANSI	FINISH						
<b>◀ Single cylinder without deadbolt</b>								
NM8050 - Office / Entrance	F04	US26D	US32D	US32	US10B	US3	US26	US4
NM8070 - Classroom	F05							
NM8080 - Storeroom	F07							
<b>◀ Single cylinder with deadbolt</b>								
NM8453 - Entrance	F20	US26D	US32D	US32	US10B	US3	US26	US4
NM8456 - Corridor	F13							
NM8495 - Keyed Privacy w/ Indicator	----							
NM8465 - Closet / Storeroom w/ DB	F65							
NM8473 - Dormitory / Bedroom	F21							
<b>◀ Double cylinder without deadbolt</b>								
NM8060 - Apartment Entrance	F09	US26D	US32D	US32	US10B	US3	US26	US4
NM8082 - Asylum / Institution	F30							
<b>◀ Double cylinder with deadbolt</b>								
NM8466 - Storeroom	F14	US26D	US32D	US32	US10B	US3	US26	US4
<b>◀ Other Functions</b>								
NM8440 - Privacy with Deadbolt	F19	US26D	US32D	US32	US10B	US3	US26	US4
NM8445 - Privacy with Deadbolt, Coin Turn & Indicator	F19B							
NM8010 - Passage	F01							
NM8170 - Single Fixed Dummy	----							
NM8172 - Double Fixed Dummy	----							

**••** All keyed lock functions are available with Best, Falcon and Arrow, Schlage, Corbin / Russwin, Sargent, and Yale Large Format Interchangeable Cores. For IC Core see pages L105 – L106. For Keying see page L115.

## HEAVY DUTY, GRADE 1 MORTISE LOCKSET

**Optional Interchangeable Core Small Format (Best, Falcon and Arrow) or Large Format (Schlage)**



**LIFETIME WARRANTY**

**BHMA**  
CERTIFIED  
Be Safe. Be Secure. Look for the Mark.

**MEETS**  
*The Buy American Act*

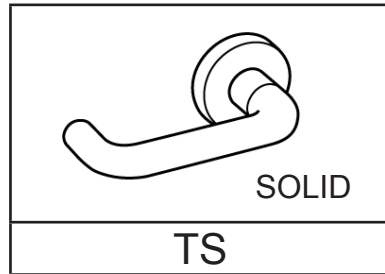
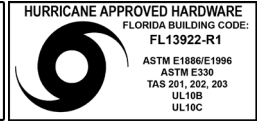

**STOCK ITEM IN BOLD>. (FOR OTHER DESIGNS, SEE NEXT PAGE)**

**NON-STOCK FINISH AVAILABLE WITH FACTORY LEAD TIME AND SUBJECT TO MINIMUM ORDER**

### TS SECTIONAL TRIM ONLY

FUNCTIONS	ANSI	FINISH						
<b>◀ Single cylinder without deadbolt</b>								
NM8050 - Office / Entrance	F04	<b>US26D</b>	<b>US32D</b>	US32	US10B	US3	US26	US4
NM8070 - Classroom	F05			US32	US10B	US3	US26	US4
NM8080 - Storeroom	F07			US32	US10B	US3	US26	US4
<b>◀ Single cylinder with deadbolt</b>								
NM8453 - Entrance	F20	<b>US26D</b>	<b>US32D</b>	US32	US10B	US3	US26	US4
NM8456 - Corridor	F13		US32D					
NM8495 - Keyed Privacy w/ Indicator	----		US32D					
NM8465 - Closet / Storeroom w/ DB	F65		US32D					
NM8473 - Dormitory / Bedroom	F21							
<b>◀ Double cylinder without deadbolt</b>								
NM8060 - Apartment Entrance	F09	<b>US26D</b>	<b>US32D</b>	US32	US10B	US3	US26	US4
NM8082 - Asylum / Institution	F30							
<b>◀ Double cylinder with deadbolt</b>								
NM8466 - Storeroom	F14	<b>US26D</b>						
<b>◀ Other Functions</b>								
NM8440 - Privacy with Deadbolt	F19	<b>US26D</b>	<b>US32D</b>	US32	US10B	US3	US26	US4
NM8445 - Privacy with Deadbolt, Coin Turn & Indicator	F19B		US32D					
NM8010 - Passage	F01		US32D					
NM8170 - Single Fixed Dummy	----		US32D					
NM8172 - Double Fixed Dummy	----		US32D					

**◀ All keyed lock functions are available with Best, Falcon and Arrow, Schlage, Corbin / Russwin, Sargent, and Yale Large Format Interchangeable Cores. For IC Core see pages L105 – L106. For Keying see page L115.**

## HEAVY DUTY, GRADE 1 MORTISE LOCKSET

**Optional Interchangeable Core Small Format (Best, Falcon and Arrow)  
or Large Format (Schlage)**





**LIFETIME WARRANTY**

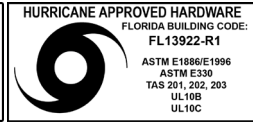

**MEETS**  
*The Buy American Act*

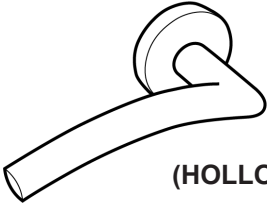
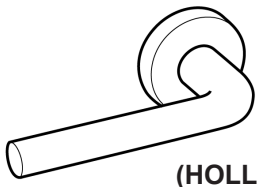
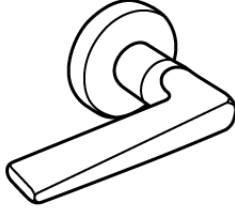
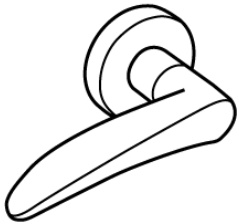
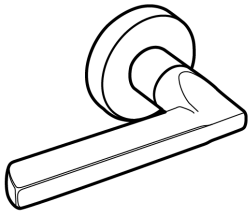
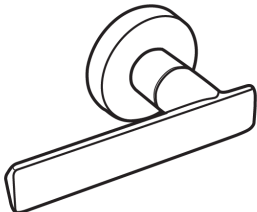
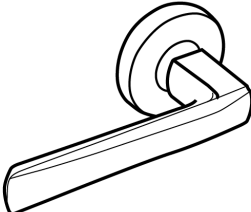
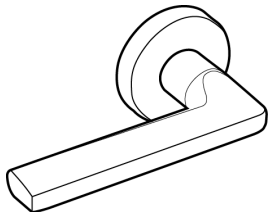
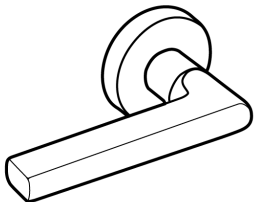
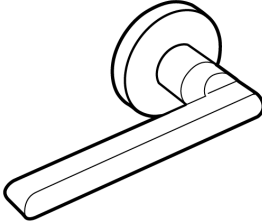
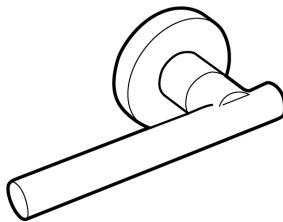
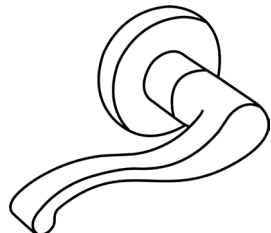
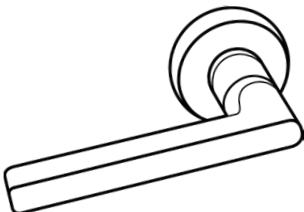

## SECTIONAL TRIMS

 <p>(HOLLOW)</p> <p><b>CS</b></p>	 <p>(HOLLOW)</p> <p><b>HS</b></p>	 <p><b>VS</b></p>	 <p><b>YS</b></p>
 <p><b>FS</b></p>	 <p><b>IS</b></p>	 <p><b>DS</b></p>	 <p><b>MS</b></p>
 <p><b>QS</b></p>	 <p><b>ZS</b></p>	 <p><b>RS</b></p>	 <p><b>PS</b></p>
 <p><b>WS</b></p>	 <p><b>XS</b></p>		

## NM Series



**LIFETIME WARRANTY**



**MEETS**  
*The Buy American Act*

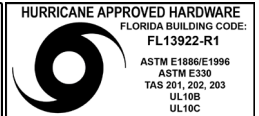

**NON-STOCK ITEMS**

**ALL ITEMS BELOW AVAILABLE WITH FACTORY LEAD TIME AND SUBJECT TO MINIMUM ORDER QUANTITY**

**CS, HS, VS, YS, DS, FS, IS, MS, QS, RS, PS, WS, XS, ZS  
SECTIONAL TRIM ONLY**

FUNCTIONS	ANSI	FINISH						
<b>◀ Single cylinder without deadbolt</b>								
NM8050 - Office / Entrance	F04	US26D	US32D	US32	US10B	US3	US26	US4
NM8070 - Classroom	F05							
NM8080 - Storeroom	F07							
<b>◀ Single cylinder with deadbolt</b>								
NM8453 - Entrance	F20	US26D	US32D	US32	US10B	US3	US26	US4
NM8456 - Corridor	F13							
NM8495 - Keyed Privacy w/ Indicator	----							
NM8465 - Closet / Storeroom w/ DB	F65							
NM8473 - Dormitory / Bedroom	F21							
<b>◀ Double cylinder without deadbolt</b>								
NM8060 - Apartment Entrance	F09	US26D	US32D	US32	US10B	US3	US26	US4
NM8082 - Asylum / Institution	F30							
<b>◀ Double cylinder with deadbolt</b>								
NM8466 - Storeroom	F14							
<b>◀ Other Functions</b>								
NM8440 - Privacy with Deadbolt	F19	US26D	US32D	US32	US10B	US3	US26	US4
NM8445 - Privacy with Deadbolt, Coin Turn & Indicator	F19B							
NM8010 - Passage	F01							
NM8170 - Single Fixed Dummy	----							
NM8172 - Double Fixed Dummy	----							

**⚙️** All keyed lock functions are available with **Best, Falcon and Arrow, Schlage, Corbin / Russwin, Sargent, and Yale Large Format Interchangeable Cores**. For IC Core see pages L105 – L106. For Keying see page L115.

## HEAVY DUTY, GRADE 1 MORTISE LOCKSET

**Optional Interchangeable Core Small Format (Best, Falcon and Arrow) or Large Format (Schlage)**

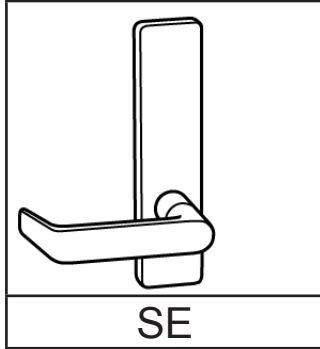

<p>3 HOUR FIRE RATED UL10C, UBC7-2-1997</p>	<p><b>LIFETIME WARRANTY</b></p>	<p><b>BHMA</b> CERTIFIED Be Safe. Be Secure. Look for the Mark.</p>	<p><b>MEETS</b> <i>The Buy American Act</i></p>
---	---------------------------------	---	---



**STOCK ITEM IN BOLD>. (FOR OTHER DESIGNS, SEE NEXT PAGE)**

**NON-STOCK FINISH AVAILABLE WITH FACTORY LEAD TIME AND SUBJECT TO MINIMUM ORDER**

SE ESCUTCHEON TRIM ONLY							
FUNCTIONS		ANSI	FINISH				
<b>◀ Single cylinder without deadbolt</b>							
NM8050 - Office / Entrance	F04	<b>US26D</b>	US32D	US10B	US3	US26	US4
NM8070 - Classroom	F05						
NM8080 - Storeroom	F07						
<b>◀ Single cylinder with deadbolt</b>							
NM8453 - Entrance	F20	<b>US26D</b>	US32D	<b>US10B</b>	<b>US3</b>	<b>US26</b>	US4
NM8456 - Corridor	F13			US10B	US3	US26	
NM8495 - Keyed Privacy w/ Indicator	----						
NM8465 - Closet / Storeroom w/ DB	F65						
NM8473 - Dormitory / Bedroom	F21						
<b>◀ Double cylinder without deadbolt</b>							
NM8060 - Apartment Entrance	F09	<b>US26D</b>	US32D	US10B	US3	US26	US4
NM8082 - Asylum / Institution	F30						
<b>◀ Double cylinder with deadbolt</b>							
NM8466 - Storeroom	F14						
<b>◀ Other Functions</b>							
NM8440 - Privacy with Deadbolt	F19	<b>US26D</b>	US32D	US10B	US3	US26	US4
NM8445 - Privacy with Deadbolt, Coin Turn & Indicator	F19B						
NM8010 - Passage	F01						
NM8170 - Single Fixed Dummy	----						
NM8172 - Double Fixed Dummy	----						

**Optional Interchangeable Cores.** For IC Core see pages L105 – L106. For Keying see page L115.

## HEAVY DUTY, GRADE 1 MORTISE LOCKSET

**Optional Interchangeable Core Small Format (Best, Falcon and Arrow) or Large Format (Schlage)**

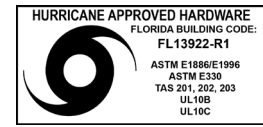
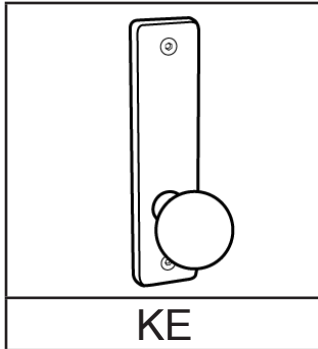

**STOCK ITEM IN BOLD>. (FOR OTHER DESIGNS, SEE NEXT PAGE)**

**NON-STOCK FINISH AVAILABLE WITH FACTORY LEAD TIME AND SUBJECT TO MINIMUM ORDER**

KE ESCUTCHEON TRIM ONLY							
FUNCTIONS		ANSI	FINISH				
<b>◀ Single cylinder without deadbolt</b>							
NM8050 - Office / Entrance	F04	<b>US26D</b>	US32D	US10B	US3	US26	US4
NM8070 - Classroom	F05						
NM8080 - Storeroom	F07						
<b>◀ Single cylinder with deadbolt</b>							
NM8453 - Entrance	F20	<b>US26D</b>	US32D	US10B	US3	US26	US4
NM8456 - Corridor	F13						
NM8495 - Keyed Privacy w/ Indicator	----						
NM8465 - Closet / Storeroom w/ DB	F65	US26D					
NM8473 - Dormitory / Bedroom	F21						
<b>◀ Double cylinder without deadbolt</b>							
NM8060 - Apartment Entrance	F09	US26D	US32D	US10B	US3	US26	US4
NM8082 - Asylum / Institution	F30						
<b>◀ Double cylinder with deadbolt</b>							
NM8466 - Storeroom	F14						
<b>◀ Other Functions</b>							
NM8440 - Privacy with Deadbolt	F19	<b>US26D</b>	US32D	US10B	US3	US26	US4
NM8445 - Privacy with Deadbolt, Coin Turn & Indicator	F19B						
NM8010 - Passage	F01						
NM8170 - Single Fixed Dummy	----	US26D					
NM8172 - Double Fixed Dummy	----						

**Optional Interchangeable Cores.** All keyed lock functions are available with **Best, Falcon and Arrow, Schlage, Corbin / Russwin, Sargent, and Yale Large Format Interchangeable Cores.** For IC Core see pages L105 – L106. For Keying see page L115.



## HEAVY DUTY, GRADE 1 MORTISE LOCKSET

**Optional Interchangeable Core Small Format (Best, Falcon and Arrow) or Large Format (Schlage)**

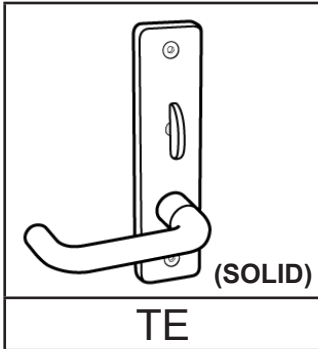

**LIFETIME WARRANTY**

**BHMA CERTIFIED**  
Be Safe. Be Secure. Look for the Mark.

**MEETS**  
*The Buy American Act*

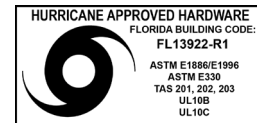

**STOCK ITEM IN BOLD>. (FOR OTHER DESIGNS, SEE NEXT PAGE)**  
**NON-STOCK FINISH AVAILABLE WITH FACTORY LEAD TIME AND SUBJECT TO MINIMUM ORDER**

TE ESCUTCHEON TRIM ONLY							
FUNCTIONS		ANSI	FINISH				
<b>◀ Single cylinder without deadbolt</b>							
NM8050 - Office / Entrance	F04						
NM8070 - Classroom	F05	<b>US26D</b>	<b>US32D</b>	US10B	US3	US26	US4
NM8080 - Storeroom	F07						
<b>◀ Single cylinder with deadbolt</b>							
NM8453 - Entrance	F20						
NM8456 - Corridor	F13		<b>US32D</b>				
NM8495 - Keyed Privacy w/ Indicator	----	<b>US26D</b>	<b>US32D</b>	US10B	US3	US26	US4
NM8465 - Closet / Storeroom w/ DB	F65						
NM8473 - Dormitory / Bedroom	F21		<b>US32D</b>				
<b>◀ Double cylinder without deadbolt</b>							
NM8060 - Apartment Entrance	F09						
NM8082 - Asylum / Institution	F30	<b>US26D</b>	<b>US32D</b>	US10B	US3	US26	US4
<b>◀ Double cylinder with deadbolt</b>							
NM8466 - Storeroom	F14						
<b>◀ Other Functions</b>							
NM8440 - Privacy with Deadbolt	F19		<b>US32D</b>				
NM8445 - Privacy with Deadbolt, Coin Turn & Indicator	F19B		<b>US32D</b>				
NM8010 - Passage	F01	<b>US26D</b>		US10B	US3	US26	US4
NM8170 - Single Fixed Dummy	----						
NM8172 - Double Fixed Dummy	----		<b>US32D</b>				

**Optional Interchangeable Cores.** For IC Core see pages L105 – L106. For Keying see page L115.

## HEAVY DUTY, GRADE 1 MORTISE LOCKSET

**Optional Interchangeable Core Small Format (Best, Falcon and Arrow) or Large Format (Schlage)**



**LIFETIME WARRANTY**

**BHMA CERTIFIED**  
Be Safe. Be Secure. Look for the Mark.

**MEETS**  
*The Buy American Act*

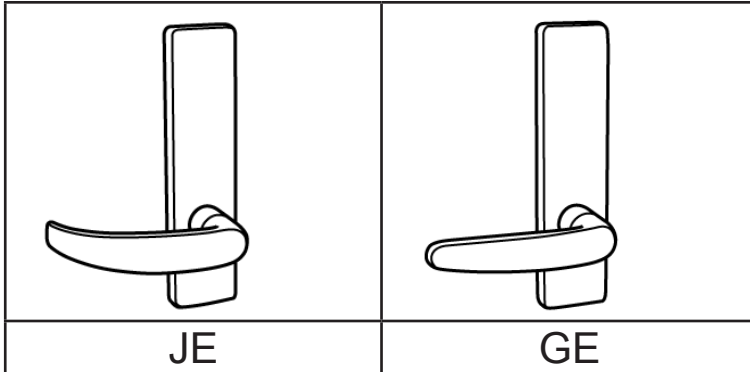
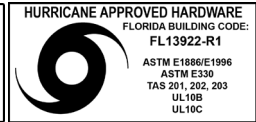

**STOCK ITEM IN BOLD.** (FOR OTHER DESIGNS, SEE NEXT PAGE)  
NON-STOCK FINISH AVAILABLE WITH FACTORY LEAD TIME AND SUBJECT TO MINIMUM ORDER

JE AND GE ESCUTCHEON TRIM ONLY							
FUNCTIONS	ANSI	FINISH					
<b>◀ Single cylinder without deadbolt</b>							
NM8050 - Office / Entrance	F04	<b>US26D</b>	US32D	US10B	US3	US26	US4
NM8070 - Classroom	F05						
NM8080 - Storeroom	F07						
<b>◀ Single cylinder with deadbolt</b>							
NM8453 - Entrance	F20	<b>US26D</b>	US32D	US10B	US3	US26	US4
NM8456 - Corridor	F13						
NM8495 - Keyed Privacy w/ Indicator	----						
NM8465 - Closet / Storeroom w/ DB	F65						
NM8473 - Dormitory / Bedroom	F21						
<b>◀ Double cylinder without deadbolt</b>							
NM8060 - Apartment Entrance	F09	<b>US26D</b>	US32D	US10B	US3	US26	US4
NM8082 - Asylum / Institution	F30	US26D					
<b>◀ Double cylinder with deadbolt</b>							
NM8466 - Storeroom	F14	<b>US26D</b>					
<b>◀ Other Functions</b>							
NM8440 - Privacy with Deadbolt	F19	<b>US26D</b>	<b>US32D</b>	US10B	US3	US26	US4
NM8445 - Privacy with Deadbolt, Coin Turn & Indicator	F19B		US32D				
NM8010 - Passage	F01		US32D				
NM8170 - Single Fixed Dummy	----						
NM8172 - Double Fixed Dummy	----						

**Optional Interchangeable Cores.** All keyed lock functions are available with **Best, Falcon and Arrow, Schlage, Corbin / Russwin, Sargent, and Yale Large Format Interchangeable Cores.** For IC Core see pages L105 – L106. For Keying see page L115.

## NM Series

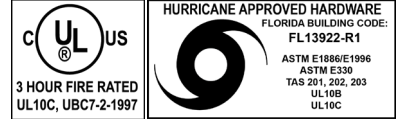

**HEAVY DUTY, GRADE 1 MORTISE LOCKSET**

**Optional Interchangeable Core Small Format (Best, Falcon and Arrow) or Large Format (Schlage)**

**ESCUTCHEON TRIMS**

**LIFETIME WARRANTY**

**BHMA**  
**CERTIFIED**  
Be Safe. Be Secure. Look for the Mark.

**MEETS**  
*The Buy American Act*

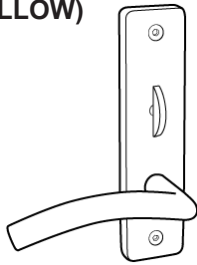
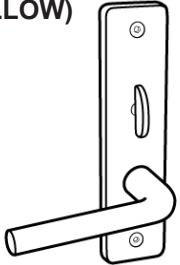
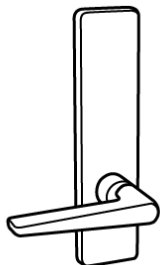
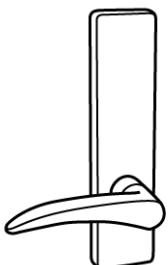
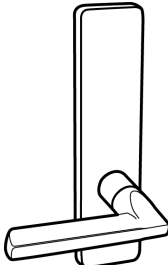
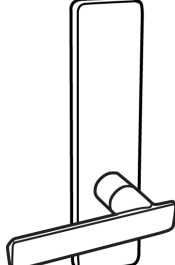
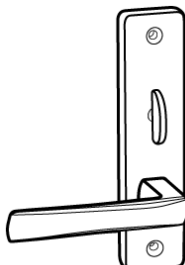
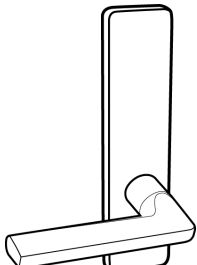
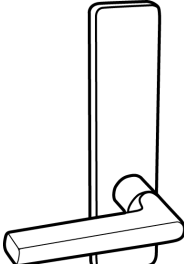
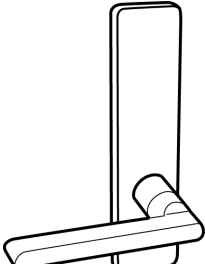
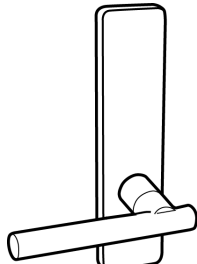
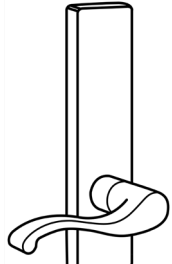
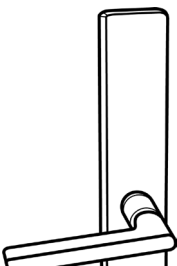
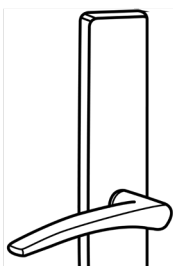
(HOLLOW)  <b>CE</b>	(HOLLOW)  <b>HE</b>	 <b>VE</b>	 <b>YE</b>
 <b>FE</b>	 <b>IE</b>	 <b>DE</b>	 <b>ME</b>
 <b>QE</b>	 <b>ZE</b>	 <b>RE</b>	 <b>PE</b>
 <b>WE</b>	 <b>XE</b>		

**HEAVY DUTY, GRADE 1 MORTISE LOCKSET**  
**Optional Interchangeable Core Small Format (Best, Falcon and Arrow) or Large Format (Schlage)**

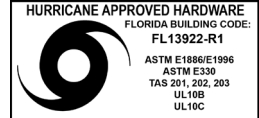

**LIFETIME WARRANTY**



**MEETS**  
*The Buy American Act*

**NON STOCK ITEMS**  
**ALL ITEMS BELOW AVAILABLE WITH FACTORY LEAD TIME AND SUBJECT TO MINIMUM ORDER QUANTITY**

**CE, HE, VE, YE, FE, IE, DE, ME, QE, ZE, RE, PE, WE, XE**  
**ESCUTCHEON TRIM ONLY**

FUNCTIONS	ANSI	FINISH					
		US26D	US32D	US10B	US3	US26	US4
<b>◀ Single cylinder without deadbolt</b>							
NM8050 - Office / Entrance	F04	US26D	US32D	US10B	US3	US26	US4
NM8070 - Classroom	F05						
NM8080 - Storeroom	F07						
<b>◀ Single cylinder with deadbolt</b>							
NM8453 - Entrance	F20	US26D	US32D	US10B	US3	US26	US4
NM8456 - Corridor	F13						
NM8495 - Keyed Privacy w/ Indicator	----						
NM8465 - Closet / Storeroom w/ DB	F65						
NM8473 - Dormitory / Bedroom	F21						
<b>◀ Double cylinder without deadbolt</b>							
NM8060 - Apartment Entrance	F09	US26D	US32D	US10B	US3	US26	US4
NM8082 - Asylum / Institution	F30						
<b>◀ Double cylinder with deadbolt</b>							
NM8466 - Storeroom	F14						
<b>◀ Other Functions</b>							
NM8440 - Privacy with Deadbolt	F19	US26D	US32D	US10B	US3	US26	US4
NM8445 - Privacy with Deadbolt, Coin Turn & Indicator	F19B						
NM8010 - Passage	F01						
NM8170 - Single Fixed Dummy	----						
NM8172 - Double Fixed Dummy	----						

**◉ All keyed lock functions are available with Best, Falcon and Arrow, Schlage, Corbin / Russwin, Sargent, and Yale Large Format Interchangeable Cores For IC Core see pages L105 – L106. For Keying see page L115.**

## WI Series

HEAVY DUTY, GRADE 1 WIDE ESCUTCHEON MORTISE LOCKSET

Optional Interchangeable Core Small Format (Best, Falcon and Arrow) or Large Format (Schlage)

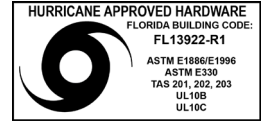

**LIFETIME WARRANTY**

**BHMA**  
CERTIFIED  
Be Safe. Be Secure. Look for the Mark.

**MEETS**  
*The Buy American Act*

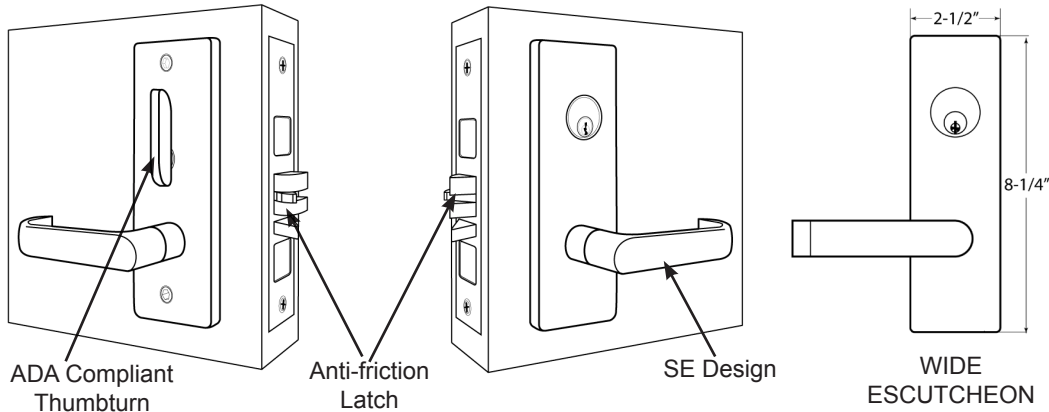

**STOCK ITEM IN BOLD.** (FOR OTHER DESIGNS, SEE NEXT PAGE)  
NON-STOCK FINISH AVAILABLE WITH FACTORY LEAD TIME AND SUBJECT TO MINIMUM ORDER

WIDE ESCUTCHEON SE TRIM ONLY						
FUNCTIONS	ANSI	FINISH				
<b>◀ Single cylinder without deadbolt</b>						
WI8050 - Office / Entrance	F04	<b>US26D</b>	US10B	US3	US26	US4
WI8070 - Classroom	F05					
WI8080 - Storeroom	F07					
<b>◀ Single cylinder with deadbolt</b>						
WI8453 - Entrance	F20	<b>US26D</b>	US10B	US3	US26	US4
WI8456 - Corridor	F13					
WI8495 - Keyed Privacy w/ Indicator	----					
WI8465 - Closet / Storeroom w/ DB	F65					
WI8473 - Dormitory / Bedroom	F21					
<b>◀ Double cylinder without deadbolt</b>						
WI8060 - Apartment Entrance	F09	<b>US26D</b>	US10B	US3	US26	US4
WI8082 - Asylum / Institution	F30					
<b>◀ Double cylinder with deadbolt</b>						
WI8466 - Storeroom	F14					
<b>◀ Other Functions</b>						
WI8440 - Privacy with Deadbolt	F19	<b>US26D</b>	US10B	US3	US26	US4
WI8445 - Privacy with Deadbolt, Coin Turn & Indicator	F19B	US26D				
WI8010 - Passage	F01	<b>US26D</b>				
WI8170 - Single Fixed Dummy	----					

Optional Interchangeable Cores For IC Core see pages L105 - L106. For Keying see page L115.

## WI Series

HEAVY DUTY, GRADE 1 WIDE ESCUTCHEON MORTISE LOCKSET

Optional Interchangeable Core Small Format (Best, Falcon and Arrow) or Large Format (Schlage)

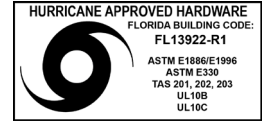

<p>3 HOUR FIRE RATED UL10C, UBC7-2-1997</p>	<p><b>LIFETIME WARRANTY</b></p>	<p><b>BHMA</b> CERTIFIED Be Safe. Be Secure. Look for the Mark.</p>	<p><b>MEETS</b> <i>The Buy American Act</i></p>
---	---------------------------------	---	---

CE*	DE*	GE	HE*	JE	KE	TE*	VE	YE

**ALL ITEMS BELOW AVAILABLE WITH FACTORY LEAD TIME AND SUBJECT TO MINIMUM ORDER QUANTITY**

### WIDE ESCUTCHEON CE, DE, GE, HE, JE, KE, TE, VE, YE TRIM ONLY

FUNCTIONS	ANSI	FINISH				
<b>◀ Single cylinder without deadbolt</b>						
WI8050 - Office / Entrance	F04	US26D	*US32D	US32	US10B	US3
WI8070 - Classroom	F05					
WI8080 - Storeroom	F07					
<b>◀ Single cylinder with deadbolt</b>						
WI8453 - Entrance	F20	US26D	*US32D	US32	US10B	US3
WI8456 - Corridor	F13					
WI8495 - Keyed Privacy w/ Indicator	----					
WI8465 - Closet / Storeroom w/ DB	F65					
WI8473 - Dormitory / Bedroom	F21					
<b>◀ Double cylinder without deadbolt</b>						
WI8060 - Apartment Entrance	F09	US26D	*US32D	US32	US10B	US3
WI8082 - Asylum / Institution	F30					
<b>◀ Double cylinder with deadbolt</b>						
WI8466 - Storeroom	F14					
<b>◀ Other Functions</b>						
WI8440 - Privacy with Deadbolt	F19	US26D	*US32D	US32	US10B	US3
WI8445 - Privacy with Deadbolt, Coin Turn & Indicator	F19B					
WI8010 - Passage	F01					
WI8170 - Single Fixed Dummy	----					

All keyed lock functions are available with Best, Falcon and Arrow, Schlage, Corbin / Russwin, Sargent, and Yale Large Format Interchangeable Cores For IC Core see pages L105 – L106. For Keying see page L115.

\*US32D Finish is not applicable to CE, DE, HE, TE Trims. Refer to page L13 for CE, DE, HE, TE US32D finish.

## WI Series

HEAVY DUTY, GRADE 1 WIDE ESCUTCHEON MORTISE LOCKSET

Optional Interchangeable Core Small Format (Best, Falcon and Arrow) or Large Format (Schlage)

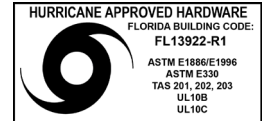

**LIFETIME WARRANTY**

**BHMA CERTIFIED**  
Be Safe. Be Secure. Look for the Mark.

**MEETS**  
*The Buy American Act*

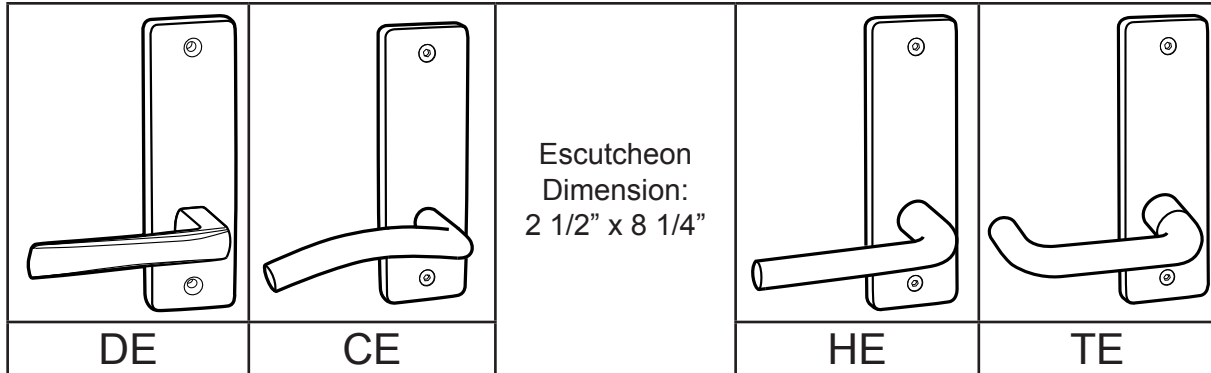

**ALL ITEMS BELOW AVAILABLE WITH FACTORY LEAD TIME AND SUBJECT TO MINIMUM ORDER QUANTITY**

### WIDE ESCUTCHEON WDE, WCE, WHE, WTE TRIM ONLY

FUNCTIONS	ANSI	FINISH
<b>◀ Single cylinder without deadbolt</b>		
WI8050 - Office / Entrance	F04	US32D
WI8070 - Classroom	F05	
WI8080 - Storeroom	F07	
<b>◀ Single cylinder with deadbolt</b>		
WI8453 - Entrance	F20	US32D
WI8456 - Corridor	F13	
WI8495 - Keyed Privacy w/ Indicator	----	US32D
WI8465 - Closet / Storeroom w/ DB	F65	US32D
WI8473 - Dormitory / Bedroom	F21	
<b>◀ Double cylinder without deadbolt</b>		
WI8060 - Apartment Entrance	F09	US32D
WI8082 - Asylum / Institution	F30	
<b>◀ Double cylinder with deadbolt</b>		
WI8466 - Storeroom	F14	
<b>◀ Other Functions</b>		
WI8440 - Privacy with Deadbolt	F19	US32D
WI8445 - Privacy with Deadbolt, Coin Turn & Indicator	F19B	
WI8010 - Passage	F01	
WI8170 - Single Fixed Dummy	----	

Optional Interchangeable Cores. For IC Core see pages L105 – L106. For Keying see page L115.

## M & SM Series

HEAVY DUTY, GRADE 1 MORTISE DEADBOLTS

**Optional Interchangeable Core Small Format (Best, Falcon and Arrow) or Large Format (Schlage)**

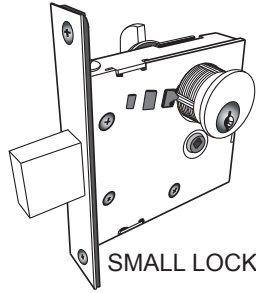

SMALL LOCKCASE

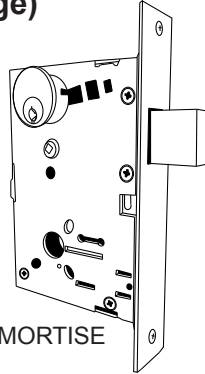

FULL MORTISE



**LIFETIME WARRANTY**

**BHMA CERTIFIED**  
Be Safe. Be Secure. Look for the Mark.

**MEETS**  
The Buy American Act

**STOCK ITEM IN BOLD**  
**NON-STOCK FINISH AVAILABLE WITH FACTORY LEAD TIME AND SUBJECT TO MINIMUM ORDER**

MODEL#	ANSI	FINISH	FUNCTIONS	MODEL#	ANSI	FINISH
SM4808	E06071	<b>US26D, 32D</b>	<b>Cylinder and Thumbturn</b> Deadbolt thrown or retracted by key outside or thumbturn inside.	M8460	F17	<b>US26D, 32D</b>
SM4828	E06061			M8462	F16	
SM4838	E06091			M8463	F29	
SM4848	E06081			M8464	F18	
SM4808	----	<b>US26D, 32D</b>	<b>Door Bolt</b> Deadbolt thrown or retracted by thumbturn from one side. No trim on opposite side.	M8480	----	<b>US26D, 32D</b>
SM4968	----			M8496	----	
		<b>US10B, 3, 26, 4</b>	<b>Classroom Lock</b> Deadbolt thrown or retracted by key from outside. Inside cylinder turn retracts deadbolt but cannot project it.			<b>US10B, 3, 26, 4</b>
		<b>US10B, 3, 26, 4</b>	<b>Cylinder Lock</b> Deadbolt thrown or retracted by key from one side. No trim on opposite side.			<b>US10B, 3, 26, 4</b>

**Optional Interchangeable Cores.** For IC Core see pages L105 – L106. For Keying see page L115.



# NM Series

HEAVY DUTY, GRADE 1 MORTISE LOCKSET

► **PACKAGING INCLUDES**

- 6 locks per case
- UL listed single point latch
- Standard "C", 6-pin cylinder
- Non-handed strike

► **KEYWAYS**

6-pin solid brass "C" keyway standard. Optional: Schlage E, Schlage C-K, Russwin D1-2-3-4, Corbin 59 / 60, Arrow A, Corbin-Russwin L4, Sargent LA-LB-LC, Falcon / Weiser E, Yale 8, Yale GA and Kwikset. Can also accept Medeco, Assa, Kaba and **Cal-Royal HSK** High Security Cylinders. See **page L115** for keying s and Cylinder PART #.

When using 1 1/8" length Mortise cylinder for sectional trim and 1 1/4" length Mortise cylinder for Escutcheon **MUST USE CLOVER CAM** supplied by Cal-Royal.

**Part # MCAM**

► **IC CORE**

● For **Best, Falcon and Arrow** Interchangeable Core prefix "IC" before **Part #**.  
 (Mortise housing **Part # ICH961387**)

● For **Schlage** Large Format Interchangeable Core prefix "ICSC",  
 For **Corbin / Russwin** Large Format Interchangeable Core prefix "ICCR",  
 For **Sargent** Large Format Interchangeable Core prefix "ICSA",  
 For **Yale** Large Format Interchangeable Core prefix "ICYA"  
 before **Part #**.  
 (Mortise housing **Part # 7000ICMC**)  
**Refer to pages L105 – L106 for Core.**

**Due to easy reversibility of NM Series, if handing is not available at time of shipment opposite hand will be shipped**

► **QUICKMARK TEMPLATE**

Available heavy duty steel template for fast and easy installation. Reduces installation time. Eliminates using paper templates.  
**Part # MTCAL**

► **OPTIONAL ADA THUMBTURN**

Prefix "ADA" before Mortise lock **ITEM#**  
 Use **Part # "ADATHUMB"** when ordering separately.

► FOR 2" up to 2 1/4" Thick door

**Order kit:**  
 SSMKIT214 - for sectional trim  
 SEMKIT214 - for escutcheon trim

► **TACTILE**

Tactile: Part # TAC

► **ELECTRIFIED**

Available on Storeroom with or without deadbolt

- Electrified Part # ELEC
- (Specify Options)

**FEATURES:**

- UL and CSFM Listings
- Continuous duty solenoids for cooler operation during "continuously on" applications
- Standard plug-in rectifier allows for an AC or DC power source
- Low current draw
- Numerous switch options
- 3 year "No Hassle" warranty

**OPTIONS:**

- Voltage requirement -12 VAC / DC or 24 VAC / DC
- Amperage - 700mA @ 12V or 350mA @ 24V
- Function - available "Fail Safe" (FS) or "Fail Secure" (FSE)

- **REX** - Request to Exit  
 Available on NM8080 and NM8480 Functions

► **LEAD LINING**

- Part # LEAD

► **ANTI MICROBIAL COATING**

Available on US26D and US32D FINISH.  
 Prefix "ANTB" before **Part #**.

ADA THUMBTURN

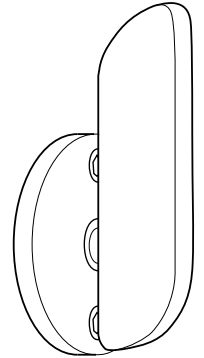

► **HOW TO ORDER**

1. Office Function
2. SS Trim Sectional
3. Satin Chrome
4. Right Handed

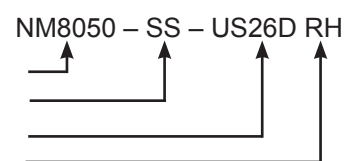

## SC Series

HEAVY DUTY, GRADE 1 MORTISE LOCKSET

**Optional Interchangeable Core Small Format (Best, Falcon and Arrow) or Large Format (Schlage)**

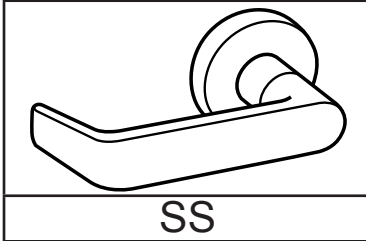

**LIFETIME WARRANTY**

**BHMA**  
CERTIFIED  
Be Safe. Be Secure. Look for the Mark.

**MEETS**  
*The Buy American Act*

### STOCK ITEM IN BOLD and SHADED AREAS

NON-STOCK FINISH AVAILABLE WITH FACTORY LEAD TIME AND SUBJECT TO MINIMUM ORDER

#### SS SECTIONAL TRIM ONLY

FUNCTIONS	ANSI	FINISH						
<b>◀ Single cylinder without deadbolt</b>								
SC8050 - Office / Entrance	F04	<b>US26D</b>	US32D	US32	US10B	US3	US26	US4
SC8070 - Classroom	F05							
SC8080 - Storeroom	F07							
<b>◀ Single cylinder with deadbolt</b>								
SC8453 - Entrance	F20	<b>US26D</b>	US32D	US32	US10B	US3	US26	US4
SC8456 - Corridor	F13							
SC8465 - Closet / Storeroom w/ DB	F65							
SC8495 - Privacy w/ Indicator	----	US26D						
SC8486 - Faculty Restroom w/ Indicator	----	US26D						
SC8473 - Dormitory / Bedroom	F21	<b>US26D</b>						
<b>◀ Double cylinder without deadbolt</b>								
SC8060 - Apartment Entrance	F09	<b>US26D</b>	US32D	US32	US10B	US3	US26	US4
SC8082 - Asylum / Institution	F30							
SC8071 - Classroom Security Lock	F32							
<b>◀ Double cylinder with deadbolt</b>								
SC8466 - Store Door Lock	F14	<b>US26D</b>	US32D	US32	US10B	US3	US26	US4
SC8457 - Classroom Security w/ DB	F33							
<b>◀ Other Functions</b>								
SC8458 - Classroom w/ DB & Aux Latch	F34	<b>US26D</b>	US32D	US32	US10B	US3	US26	US4
SC8440 - Privacy with Deadbolt	F19	<b>US26D</b>						
SC8445 - Privacy w/ Deadbolt, Coin turn & Indicator	F19B	US26D	<b>US26D</b>	US32D	US32	US10B	US3	US26
SC8170 - Single Fixed Dummy	----	<b>US26D</b>						
SC8010 - Passage	F01	<b>US26D</b>	US32D	US32	US10B	US3	US26	US4

**Optional Interchangeable Cores.** For IC Core see pages L105 – L106. For Keying see page L115.

## SC Series

HEAVY DUTY, GRADE 1 MORTISE LOCKSET

**Optional Interchangeable Core Small Format (Best, Falcon and Arrow) or Large Format (Schlage)**

	<b>LIFETIME WARRANTY</b>	<b>BHMA</b> CERTIFIED Be Safe. Be Secure. Look for the Mark.	<b>MEETS</b> The Buy American Act
--	--------------------------	--	--------------------------------------

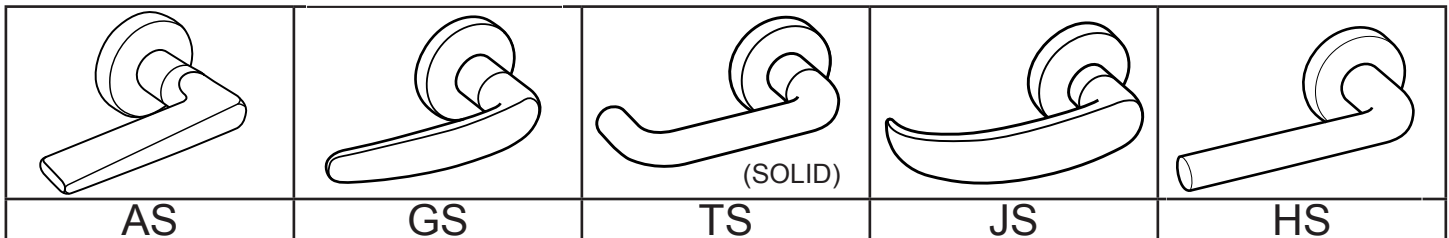

**STOCK ITEM IN BOLD and SHADED AREAS**  
NON-STOCK FINISH AVAILABLE WITH FACTORY LEAD TIME AND SUBJECT TO MINIMUM ORDER

AS, GS, TS, JS, HS SERIES SECTIONAL TRIM ONLY									
FUNCTIONS		ANSI	FINISH						
<b>◀Single cylinder without deadbolt</b>									
SC8050 - Office / Entrance	F04	US26D	US32D	US32	US10B	US3	US26	US4	
SC8070 - Classroom	F05								
SC8080 - Storeroom	F07								
<b>◀Single cylinder with deadbolt</b>									
SC8453 - Entrance	F20	US26D	US32D	US32	US10B	US3	US26	US4	
SC8456 - Corridor	F13								
SC8465 - Closet / Storeroom w/ DB	F65								
SC8495 - Privacy w/ Indicator	----								
SC8486 - Faculty Restroom w/ Indicator	----								
SC8473 - Dormitory / Bedroom	F21								
<b>◀Double cylinder without deadbolt</b>									
SC8060 - Apartment Entrance	F09	US26D	US32D	US32	US10B	US3	US26	US4	
SC8082 - Asylum / Institution	F30								
SC8071 - Classroom Security Lock	F32								
<b>◀Double cylinder with deadbolt</b>									
SC8466 - Store Door Lock	F14	US26D	US32D	US32	US10B	US3	US26	US4	
SC8457 - Classroom Security w/ DB	F33								
<b>◀Other Functions</b>									
SC8458 - Classroom w/ DB & Aux Latch	F34	US26D	US32D	US32	US10B	US3	US26	US4	
SC8440 - Privacy with Deadbolt	F19								
SC8445 - Privacy w/ Deadbolt, Coin turn & Indicator	F19B								
SC8170 - Single Fixed Dummy	----								
SC8010 - Passage	F01								

**Optional Interchangeable Cores.** For IC Core see pages L105 – L106. For Keying see page L115.

## SC Series

HEAVY DUTY, GRADE 1 WIDE ESCUTCHEON MORTISE LOCKSET

Optional Interchangeable Core Small Format (Best, Falcon and Arrow) or Large Format (Schlage)

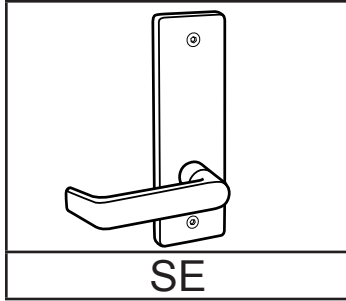

**STOCK ITEM IN BOLD and SHADED AREAS**  
NON-STOCK FINISH AVAILABLE WITH FACTORY LEAD TIME AND SUBJECT TO MINIMUM ORDER

SE WIDE ESCUTCHEON TRIM ONLY									
FUNCTIONS	ANSI	FINISH							
<b>◀Single cylinder without deadbolt</b>									
SC8050 - Office / Entrance	F04	<b>US26D</b>	US32D	US32	US10B	US3	US26	US4	
SC8070 - Classroom	F05								
SC8080 - Storeroom	F07								
<b>◀Single cylinder with deadbolt</b>									
SC8453 - Entrance	F20	<b>US26D</b>	US32D	US32	US10B	US3	US26	US4	
SC8456 - Corridor	F13								
SC8465 - Closet / Storeroom w/ DB	F65								
SC8495 - Privacy w/ Indicator	----	<b>US26D</b>	US32D	US32	US10B	US3	US26	US4	
SC8486 - Faculty Restroom w/ Indicator	----								
SC8473 - Dormitory / Bedroom	F21	<b>US26D</b>							
<b>◀Double cylinder without deadbolt</b>									
SC8060 - Apartment Entrance	F09	<b>US26D</b>	US32D	US32	US10B	US3	US26	US4	
SC8082 - Asylum / Institution	F30								
SC8071 - Classroom Security Lock	F32								
<b>◀Double cylinder with deadbolt</b>									
SC8466 - Store Door Lock	F14	<b>US26D</b>	US32D	US32	US10B	US3	US26	US4	
SC8457 - Classroom Security w/ DB	F33								
<b>◀Other Functions</b>									
SC8458 - Classroom w/ DB & Aux Latch	F34	<b>US26D</b>	US32D	US32	US10B	US3	US26	US4	
SC8440 - Privacy with Deadbolt	F19								
SC8445 - Privacy w/ Deadbolt, Coin turn & Indicator	F19B	<b>US26D</b>							
SC8170 - Single Fixed Dummy	----	<b>US26D</b>	US32D	US32	US10B	US3	US26	US4	
SC8010 - Passage	F01								

Optional Interchangeable Cores. For IC Core see pages L105 – L106. For Keying see page L115.

## SC Series

HEAVY DUTY, GRADE 1 WIDE ESCUTCHEON MORTISE LOCKSET

Optional Interchangeable Core Small Format (Best, Falcon and Arrow) or Large Format (Schlage)

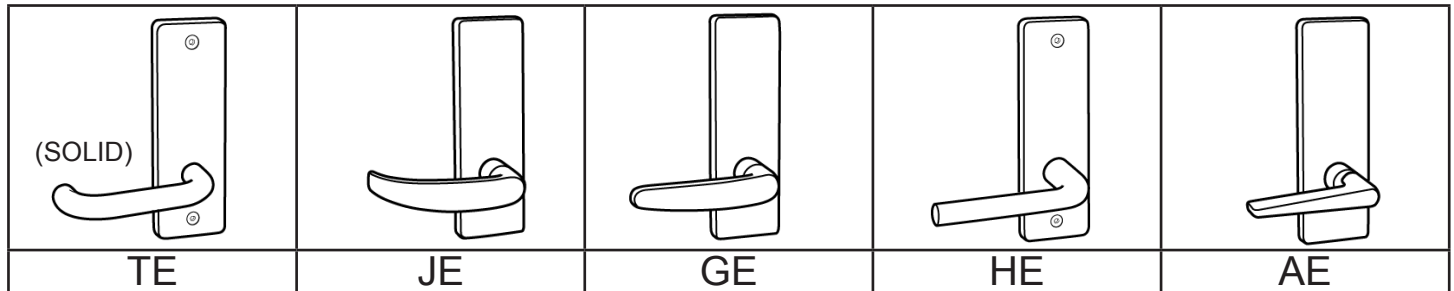

**STOCK ITEM IN BOLD and SHADED AREAS**  
NON-STOCK FINISH AVAILABLE WITH FACTORY LEAD TIME AND SUBJECT TO MINIMUM ORDER

SE WIDE ESCUTCHEON TRIM ONLY									
FUNCTIONS		ANSI	FINISH						
<b>◀Single cylinder without deadbolt</b>									
SC8050 - Office / Entrance	F04								
SC8070 - Classroom	F05	US26D	US32D	US32	US10B	US3	US26	US4	
SC8080 - Storeroom	F07								
<b>◀Single cylinder with deadbolt</b>									
SC8453 - Entrance	F20								
SC8456 - Corridor	F13								
SC8465 - Closet / Storeroom w/ DB	F65	US26D	US32D	US32	US10B	US3	US26	US4	
SC8495 - Privacy w/ Indicator	----								
SC8486 - Faculty Restroom w/ Indicator	----								
SC8473 - Dormitory / Bedroom	F21								
<b>◀Double cylinder without deadbolt</b>									
SC8060 - Apartment Entrance	F09								
SC8082 - Asylum / Institution	F30								
SC8071 - Classroom Security Lock	F32	US26D	US32D	US32	US10B	US3	US26	US4	
<b>◀Double cylinder with deadbolt</b>									
SC8466 - Store Door Lock	F14								
SC8457 - Classroom Security w/ DB	F33								
<b>◀Other Functions</b>									
SC8458 - Classroom w/ DB & Aux Latch	F34								
SC8440 - Privacy with Deadbolt	F19								
SC8445 - Privacy w/ Deadbolt, Coin turn & Indicator	F19B	US26D	US32D	US32	US10B	US3	US26	US4	
SC8170 - Single Fixed Dummy	----								
SC8010 - Passage	F01								

Optional Interchangeable Cores. For IC Core see pages L105 – L106. For Keying see page L115.

## SC Series

HEAVY DUTY, GRADE 1 MORTISE DEADBOLTS

Optional Interchangeable Core Small Format (Best, Falcon and Arrow) or Large Format (Schlage)

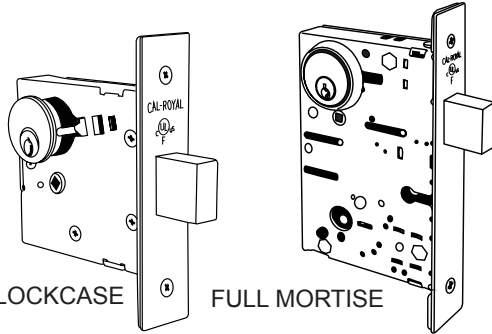

SMALL LOCKCASE

FULL MORTISE

**STOCK ITEM IN BOLD and SHADED AREAS**

NON-STOCK FINISH AVAILABLE WITH FACTORY LEAD TIME AND SUBJECT TO MINIMUM ORDER

MODEL#	ANSI	FINISH	FUNCTIONS	MODEL#	ANSI	FINISH	
SM140	...	US26D, 32D	US10B, 3, 26, 4	<b>Cylinder and Thumbturn</b> Deadbolt thrown or retracted by key outside or thumbturn inside.	SC8460	F17	
SM143	...			<b>Double Cylinder</b> Deadbolt operated by key on either side.	SC8462	F16	US26D
SM141	...			<b>Classroom Lock</b> Deadbolt thrown or retracted by key from outside. Inside cylinder turn retracts deadbolt but cannot project it.	SC8463	F29	
SM142	...			<b>Cylinder Lock</b> Deadbolt thrown or retracted by key from one side. No trim on opposite side.	SC8464	F18	US32D
SM145	...			<b>Door Bolt</b> Deadbolt thrown or retracted by thumbturn from one side. No trim on opposite side.	SC8461	...	
SM146	...			<b>Deadbolt with "OCCUPIED" indicator</b> Deadbolt thrown or retracted by key outside or thumbturn inside. "OCC" plate is displayed when deadbolt is thrown.	SC8496	...	US26D

Optional Interchangeable Cores. For IC Core see pages L105 – L106. For Keying see page L115.

## SC Series

HEAVY DUTY, GRADE 1 MORTISE LOCKSET WITH CLUTCH

•• Optional Interchangeable Core Small Format (Best, Falcon and Arrow) or Large Format (Schlage)

► **PACKAGING INCLUDES**

- 6 locks per case
- UL listed single point latch
- Standard "C", 6-pin cylinder
- Non-handed strike

► **KEYWAYS**

6-pin solid brass "C" keyway standard. Optional: Schlage E, Schlage C-K, Russwin D1-2-3-4, Corbin 59 / 60, Arrow A, Corbin-Russwin L4, Sargent LA-LB-LC, Falcon / Weiser E, Yale 8, Yale GA and Kwikset. Can also accept Medeco, Assa, Kaba and **Cal-Royal HSK** High Security Cylinders. See **page L115** for keying and Cylinder PART #.

► When using 1 1/8" length Mortise cylinder for sectional trim and 1 1/4" length Mortise cylinder for Escutcheon **MUST USE SCHLAGE CAM** supplied by Cal-Royal.

**Part # KCS7**

► **IC CORE**

•• For **Best, Falcon and Arrow** Interchangeable Core prefix "**IC**" before **Part #**. (Mortise housing **Part # ICH961387**)

•• For **Schlage** Large Format Interchangeable Core prefix "**ICSC**", For **Corbin / Russwin** Large Format Interchangeable Core prefix "**ICCR**", For **Sargent** Large Format Interchangeable Core prefix "**ICSA**", For **Yale** Large Format Interchangeable Core prefix "**ICYA**" before **Part #**. (Mortise housing **Part # 7000ICMC**)

Refer to pages L105 – L106 for Core.

► **LEAD LINING**

- Part # LEAD

► FOR 2" up to 2 1/4" Thick door

**Order kit:**

- SCSKIT200 - for sectional trim
- SCEKIT214 - for escutcheon trim

► **OPTIONAL ADA THUMBTURN**

Prefix "**ADA**" before Mortise lock **ITEM#**  
 Use **Part # "SCADA"** when ordering separately.

► **TACTILE**

Tactile: Part # TAC

► **ELECTRIFIED**

Available on Storeroom with or without deadbolt

- Electrified Part # ELEC (Specify Options)

FEATURES:

- UL and CSFM Listings
- Continuous duty solenoids for cooler operation during "continuously on" applications
- Standard plug-in rectifier allows for an AC or DC power source
- Low current draw
- Numerous switch options
- 3 year "No Hassle" warranty

OPTIONS:

- Voltage requirement -12 VAC / DC or 24 VAC / DC
- Amperage - 700mA @ 12V or 350mA @ 24V
- Function - available "Fail Safe" (FS) or "Fail Secure" (FSE)

- **REX** - Request to Exit  
 Available on SC8080 and SC8480 Functions

► **ANTI MICROBIAL COATING**

Available on US26D and US32D FINISH.  
 Prefix "**ANTB**" before **Part #**.

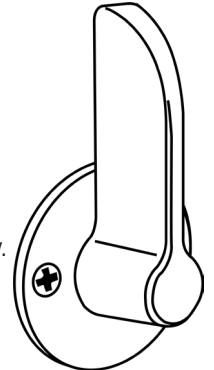

SCADA THUMBTURN

**Due to easy reversibility of SC Series, if handing is not available at time of shipment opposite hand will be shipped. ALL PRODUCTS ARE SHIPPED NON-HANDED. EASILY FIELD REVERSIBLE**







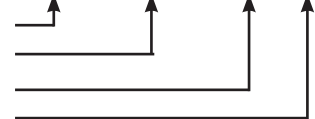





► **HOW TO ORDER**

1. Office Function
2. SS Trim Sectional
3. Satin Chrome
4. Right Handed

SC8050 – SS – US26D RH

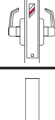

# Heavy Duty Mortise Lock COMPARISON CHART

FUNCTION	ILLUSTRATION	ANSI NO.	CAL-ROYAL MODEL NO	NT FALCON M SERIES	ARROW B Series	CORBIN/RUSSWIN	SARGENT 7800 / 8200	SCHLAGE L SERIES	PDQ MR SERIES	YALE	HAGER
ENTRANCE or OFFICE		<b>Single Cylinder Without Deadbolt</b>									
		F04	SC8050	M521	BM22	ML2051	5	L9050	MR116	8807	3850
CLASSROOM		F05	SC8070	M561	BM17	ML2055	37	L9070	MR148	8808	3870
STOREROOM or CLOSET		F07	SC8080	M371	BM12	ML2057	4	L9080	MR115	8805	3880
ENTRANCE		<b>Single Cylinder With Deadbolt</b>									
		F20	SC8453	M531	BM11	ML2067	45	L9453	MR162	8847	3853
DORMITORY / BEDROOM		F21	SC8473	M541	BM20	ML2024	24	L9473	MR135	8860	---
CORRIDOR / EXIT		F13	SC8456	M571	BM19	ML2065	25	L9456	MR136	8822	
KEYED PRIVACY INDICATOR		---	SC8495	M451	---	ML2024 M19	---	L9495 L9496	---	8864	---
CLOSET / STOREROOM w/ DEADBOLT		F65	SC8465	---	---	---	27	L9465	MR139	---	---
APARTMENT ENTRANCE / VESTIBULE		<b>Double Cylinder Without Deadbolt</b>									
		F09	SC8060	M381	BM32	ML2042	16	L9060	MR186	8817	----
INSTITUTION		F30	SC8082	M411	BM33	ML2032	17	L9082	---	8830-2	3882
STOREROOM UTILITY		<b>Double Cylinder With Deadbolt</b>									
		F14	SC8466	M371	BM31	ML2022	26	L9466	MR137	8860	----
PRIVACY or BATHROOM w/ DEADBOLT		<b>Other Functions</b>									
		F19	SC8440	M311	BM02	ML2020	65	L9040	MR178 MR179	8802	3840
PRIVACY WITH INDICATOR w/ DEADBOLT		F19B	SC8445	----	----	ML2020 M19	49	----	----	8862	3896
PASSAGE or CLOSET		F01	SC8010	M101	BM01	ML2010	13	L9010	MR126	8801	3810
SINGLE FIXED DUMMY		----	SC8170	M12	BM08	ML2050	93	L0170	MR211	8855	3817
DOUBLE FIXED DUMMY		----	SC8172	M18	BM09	ML2070	96	L0172	MR205	8838	3827



## HL Series

HOSPITAL LATCH (HL TRIM)  
HEAVY DUTY, GRADE 1 MORTISE LOCKSET

Optional Interchangeable Core Small Format (Best, Falcon and Arrow)  
or Large Format (Schlage)

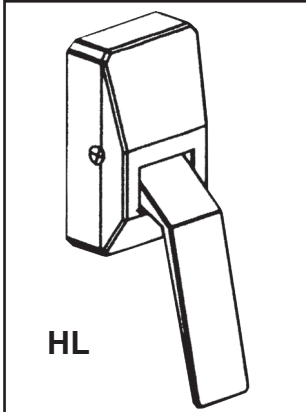

**STOCK ITEM IN BOLD**

**NON-STOCK FINISH AVAILABLE WITH FACTORY LEAD TIME AND SUBJECT TO MINIMUM ORDER**

HL SERIES TRIM ONLY								
FUNCTIONS	ANSI	FINISH						
SC8050HL - Office / Entrance	F04	<b>US26D</b>	US32D	US32	US10B	US3	US26	US4
SC8070HL - Classroom Lock	F05	<b>US26D</b>						
◀ Single cylinder with deadbolt								
SC8453HL - Entrance	F20	US26D	US32D	US32	US10B	US3	US26	US4
SC8456HL - Corridor	F13							
SC8473HL - Dormitory / Bedroom	F21							
◀ Double cylinder without deadbolt								
SC8060HL - Apartment Entrance	F09	US26D	US32D	US32	US10B	US3	US26	US4
SC8082HL - Asylum / Institution Lock	F30							
◀ Double cylinder with deadbolt								
SC8411HL - Dormitory or Exit Lock	F11	US26D	US32D	US32	US10B	US3	US26	US4
SC8466HL - Store Door Lock	F14							
◀ Other Functions								
SC8440HL - Privacy with Deadbolt	F19	<b>US26D</b>	US32D	US32	US10B	US3	US26	US4
SC8049HL - Privacy Bedroom / Bath	F22	US26D						
SC8010HL - Passage	F01							

Optional Interchangeable Cores. For IC Core see pages L105 – L106. For Keying see page L115.

## LG Series

LIGATURE RESISTANT LG TRIM  
HEAVY DUTY, GRADE 1 MORTISE LOCKSET

Optional Interchangeable Core Small Format (Best, Falcon and Arrow)  
or Large Format (Schlage)



**LIFETIME WARRANTY**

**BHMA CERTIFIED**  
Be Safe. Be Secure. Look for the Mark.

**MEETS**  
*The Buy American Act*

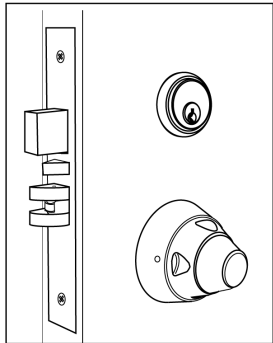

LGK

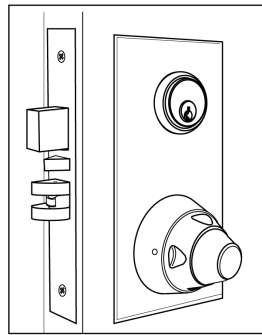

LGX

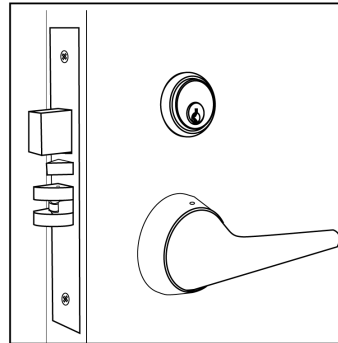

LGS

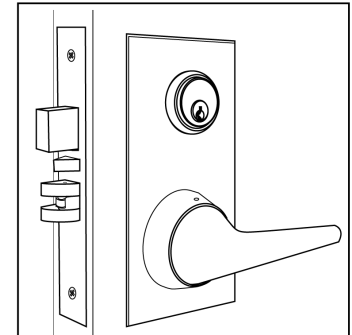

LGE

### STOCK ITEM IN BOLD

NON-STOCK FINISH AVAILABLE WITH FACTORY LEAD TIME AND SUBJECT TO MINIMUM ORDER

### LG SERIES TRIM ONLY

FUNCTIONS	ANSI	LGK	LGX	LGS	LGE
		FINISH			
<b>◀Single cylinder without deadbolt</b>					
SC8050LG - Office / Entrance	F04				
SC8070LG - Lockable Patient Room (Classroom Lock)	F05				<b>US32D</b>
SC8080LG - Medicine Storeroom (Storeroom Lock)	F07				
SC8026LG - Supervisor Office or Privacy Room (Institutional Privacy)	F26				US32D
<b>◀Single cylinder with deadbolt</b>					
SC8456LG - Nurse Dormitory with Deadbolt (Corridor)	F13				
SC8453LG - Entrance	F20				<b>US32D</b>
SC8473LG - Dormitory / Bedroom	F21				
SC8465LG - Closet / Storeroom with Deadbolt	F65				
<b>◀Double cylinder without deadbolt</b>					
SC8060LG - Apartment Entrance Lock	F09				
SC8082LG - Asylum with Double Cylinder (Asylum or Institution Lock)	F30				<b>US32D</b>
SC8071LG - Lockable Patient Room (Classroom Security Intruder Latchbolt)	F32				
<b>◀Double cylinder with deadbolt</b>					
SC8411LG - Keyed Only with Deadbolt and Latchbolt (Dormitory / Exit Lock)	F11				US32D
SC8457LG - Medical Academy Conference Room (Classroom Security Intruder Deadbolt)	F33				<b>US32D</b>
<b>◀Other Functions</b>					
SC8458LG - Classroom with Deadbolt & Auxiliary Latch	F34				<b>US32D</b>
SC8010LG - Passage Latch	F01				
SC8049LG - Privacy Bedroom / Bath (Privacy with Emergency Key)	F22				US32D
SC8440LG - Privacy with Deadbolt	F19				<b>US32D</b>

Optional Interchangeable Cores (See page L21). For IC Core see pages L105 – L106. For Keying see page L115.

## LG Series

LIGATURE RESISTANT LG TRIM

HEAVY DUTY, GRADE 1 MORTISE LOCKSET

Optional Interchangeable Core Small Format (Best, Falcon and Arrow) or Large Format (Schlage)

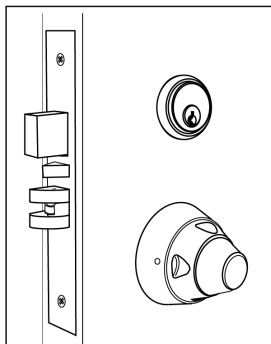

LGK

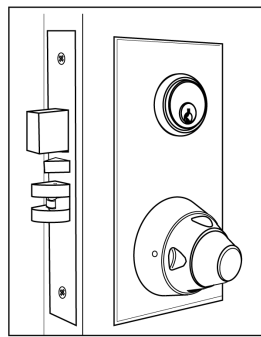

LGX

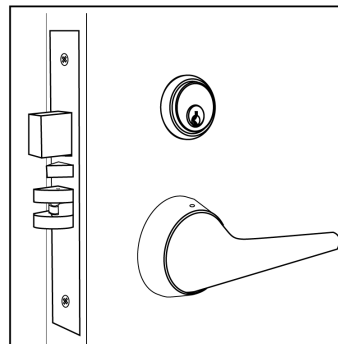

LGS

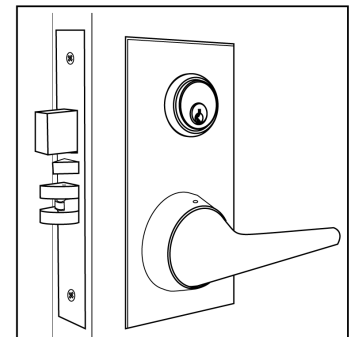

LGE

### STOCK ITEM IN **BOLD**

NON-STOCK FINISH AVAILABLE WITH FACTORY LEAD TIME AND SUBJECT TO MINIMUM ORDER

### LG SERIES TRIM ONLY

FUNCTIONS	ANSI				LGK	LGX	LGS	LGE
◀For Asylum use only no free exit	IT-Inside Thumbturn   IL-Inside Lever   IC-Inside Cylinder   OC-Outside Cylinder							
	IT	IL	IC	OC	FINISH			
SC8031LG – Asylum w/o Inside Cylinder		✓		✓	Asylum-1			
SC8032LG – Asylum w/ Double Cylinder, w/o Inside Lever			✓	✓	Asylum-2	US32D	US32D	US32D
SC8033LG – Asylum w/o Inside Cylinder and Inside Lever				✓	Asylum-3			
SC8466LG – Asylum w/ Deadbolt, Double Cylinder	✓	✓	✓		Asylum-4 (F14)	<b>US32D</b>	<b>US32D</b>	<b>US32D</b>
SC8467LG – Asylum w/ Deadbolt, Double Cylinder, w/o Inside Cylinder		✓		✓	Asylum-5 w/ deadbolt			
SC8468LG – Asylum w/ Deadbolt, w/o Inside Lever			✓	✓	Asylum-6 w/ deadbolt	US32D	US32D	US32D
SC8469LG – Asylum w/ Deadbolt, w/o Inside Cylinder and Inside Lever				✓	Asylum-7 w/ deadbolt			
◀Other Keyed Functions								
SC8055LG – Female Patient Room 1	✓	✓		✓	Female Patient Room-1			
SC8056LG – Female Patient Room 2	✓	✓		✓	Female Patient Room-2	US32D	US32D	US32D

All keyed lock functions are available with Best, Falcon and Arrow, Schlage, Corbin / Russwin, Sargent, and Yale Large Format Interchangeable Cores. For IC Core see pages L105 – L106. For Keying see page L115.

# HOSPITAL PUSH / PULL LATCH

## FOR 1 3/4" THICK DOORS



FEATURES

- UL-listed for use on all fire doors
- Meets ADA requirements
- Ideal for use in hospitals, washrooms or public buildings
- 6 possible PUSH-PULL mounting combinations
- Covers and paddles are made of stainless steel
- Non-Handed
- Standard T-Strike and plastic dust box
- 1 3/4" door thickness
- 2 3/4" backset standard, face plate 1 1/8" x 2 1/4"
- Optional 5" backsets
- 2 5/8" X 4 3/8" Covers
- 2 5/8" Handle Projection

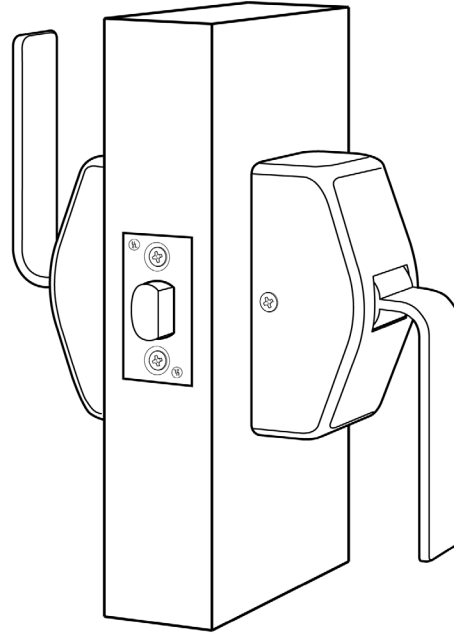













OPTIONS AVAILABLE

- Lead Lining
- Anti-Microbial
- ASA Strike

ITEM#	FUNCTIONS	DESCRIPTION	FINISH	PCS / INNER BOX	PCS / MC			
HOS-PP30	Passage	Hospital Push / Pull Latch, Non-Handed Passage Function, UL- Listed, 2 3/4" or 5" Backset	US32D	1	10			
ULHOS-PAS-5	Latchbolt	UL- Listed 5" Backset Privacy / Passage Latch		20	100			
ULHOS-PAS-234		UL- Listed 2 3/4" Backset Privacy / Passage Latch		20	100			
HOS-ANTB	Add on	Anti Microbial Coating (Inside and Outside surfaces)						
HOS-LEAD		LEAD LINING						
ASAST	Strike	ASA ANSI Strike						
EXASA-175	Strike	Extended Lip ANSI Strike					US32D, DURO	

# Heavy Duty Mortise Lock COMPARISON CHART

FUNCTION	ILLUSTRATION	ANSI NO.	CAL-ROYAL MODEL NO	NT FALCON M SERIES	ARROW B Series	CORBIN/RUSSWIN	SARGENT 7800 / 8200	SCHLAGE L SERIES	PDQ MR SERIES	YALE	HAGER
ENTRANCE or OFFICE		<b>Single Cylinder Without Deadbolt</b>									
		F04	NM8050	M521	BM22	ML2051	5	L9050	MR116	8807	3850
CLASSROOM		F05	NM8070	M561	BM17	ML2055	37	L9070	MR148	8808	3870
STOREROOM or CLOSET		F07	NM8080	M371	BM12	ML2057	4	L9080	MR115	8805	3880
APARTMENT / DORMITORY		<b>Single Cylinder With Deadbolt</b>									
		F20	NM8453	M531	BM11	ML2067	45	L9453	MR162	8847	3853
DORMITORY / BEDROOM		F21	NM8473	M541	BM20	ML2024	24	L9473	MR135	8860	---
CORRIDOR / EXIT		F13	NM8456	M571	BM19	ML2065	25	L9456	MR136	8822	---
KEYED PRIVACY INDICATOR		---	NM8495	M451	---	ML2024 M19	---	L9495 L9496	---	8864	---
CLOSET / STOREROOM		---	NM8465	---	---	---	27	L9465	MR139	---	---
APARTMENT ENTRANCE / VESTIBULE		<b>Double Cylinder Without Deadbolt</b>									
		F09	NM8060	M381	BM32	ML2042	16	L9060	MR186	8817	----
INSTITUTION		F30	NM8082	M411	BM33	ML2032	17	L9082	---	8830-2	3882
STOREROOM UTILITY		<b>Double Cylinder With Deadbolt</b>									
		F14	NM8466	M371	BM31	ML2022	26	L9466	MR137	8860	----
PRIVACY or BATHROOM		<b>Other Functions</b>									
		F19	NM8440	M311	BM02	ML2020	65	L9040	MR178 MR179	8802	3840
PRIVACY WITH INDICATOR		F19B	NM8445	----	----	ML2020 M19	49	----	----	8862	3896
PASSAGE or CLOSET		F01	NM8010	M101	BM01	ML2010	13	L9010	MR126	8801	3810
SINGLE FIXED DUMMY		----	NM8170	M12	BM08	ML2050	93	L0170	MR211	8855	3817
DOUBLE FIXED DUMMY		---	NM8172	M18	BM09	ML2070	96	L0172	MR205	8838	3827

# GENESYS Series

## HEAVY DUTY CYLINDRICAL LEVERSETS WITH CLUTCH

**ANSI - A156.2, SERIES 4000, GRADE 1**

**Optional Interchangeable Core for Best, Falcon and Arrow**

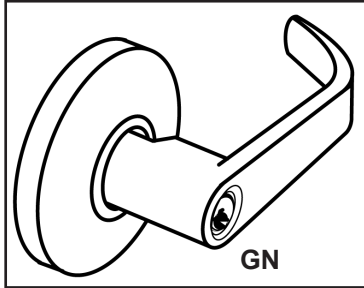

**LIFETIME WARRANTY**



**MEETS**  
*The Buy American Act*

**STOCK ITEM IN BOLD.**  
NON-STOCK FINISH AND DESIGNS AVAILABLE WITH FACTORY LEAD TIME AND SUBJECT TO MINIMUM ORDER

FUNCTIONS	ANSI	ITEM#	FINISH						PCS / MC
Entrance	F109	CGN00	<b>US26D</b>	<b>US10B</b>	<b>US3</b>	<b>US10</b>	<b>US26</b>	<b>US4</b>	10
		<b>ICCGN00</b>							
Entrance Push Button Lock	F82	CGN01	<b>US26D</b>	US10B	US3	US10	US26	US4	
		<b>ICCGN01</b>							
Store lock <b>Non Clutch</b> (keyed Dbl. cyl.)	F91	GN02	<b>US26D</b>	<b>US10B</b>	<b>US3</b>	<b>US10</b>	US26	<b>US4</b>	
		<b>ICGN02</b>							
Classroom	F84	CGN03	<b>US26D</b>	<b>US10B</b>	<b>US3</b>	<b>US10</b>	<b>US26</b>	<b>US4</b>	
		<b>ICCGN03</b>							
Communicating (keyed Dbl. cyl.)	F80	CGN04	<b>US26D</b>	US10B	US3	US10	US26	US4	
		<b>ICCGN04</b>							
Storeroom	F86	CGN05	<b>US26D</b>	<b>US10B</b>	<b>US3</b>	<b>US10</b>	<b>US26</b>	<b>US4</b>	
		<b>ICCGN05</b>							
Vestibule	F88	CGN06	<b>US26D</b>	US10B	US3	US10	US26	US4	
		<b>ICCGN06</b>							
Classroom / Intruder	F110	CGN07	<b>US26D</b>	US10B	US3	US10	US26	US4	
		<b>ICCGN07</b>							
Dormitory (Non-Clutch)	F90	GN101	<b>US26D</b>	<b>US10B</b>	<b>US3</b>	<b>US10</b>	<b>US26</b>	<b>US4</b>	
Institution (keyed Dbl. cyl.)	F87	CGN09	<b>US26D</b>	<b>US10B</b>	<b>US3</b>	<b>US10</b>	<b>US26</b>	<b>US4</b>	
		<b>ICCGN09</b>							
Privacy	F76	CGN20	<b>US26D</b>	<b>US10B</b>	<b>US3</b>	<b>US10</b>	<b>US26</b>	<b>US4</b>	
Hospital Privacy	---	HCGN20	<b>US26D</b>	<b>US10B</b>	<b>US3</b>	<b>US10</b>	<b>US26</b>	<b>US4</b>	
Passage	F75	GN30	<b>US26D</b>	<b>US10B</b>	<b>US3</b>	<b>US10</b>	<b>US26</b>	<b>US4</b>	
Exit	F89	GN50	<b>US26D</b>	<b>US10B</b>	<b>US3</b>	<b>US10</b>	<b>US26</b>	<b>US4</b>	
Single Dummy	----	GN40	<b>US26D</b>	<b>US10B</b>	<b>US3</b>	<b>US10</b>	<b>US26</b>	<b>US4</b>	20

**IC** Indicates function available with **Best, Falcon and Arrow** Interchangeable Core. For IC Core see pages L105 – L106. For Keying see page L115.

## HEAVY DUTY CYLINDRICAL LEVERSETS WITH CLUTCH ANSI - A156.2, SERIES 4000, GRADE 1

**Ⓢ** Optional Interchangeable Core for **Best, Falcon and Arrow**

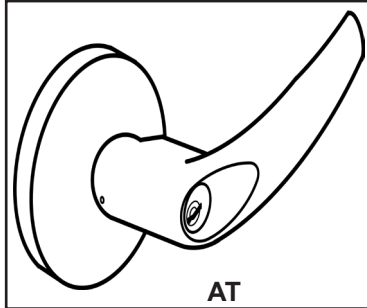

**LIFETIME WARRANTY**

**BHMA™ CERTIFIED**  
Be Safe. Be Secure. Look for the Mark.

**MEETS**  
*The Buy American Act*



**STOCK ITEM IN BOLD.**  
NON-STOCK FINISH AND DESIGNS AVAILABLE WITH FACTORY LEAD TIME AND SUBJECT TO MINIMUM ORDER

FUNCTIONS	ANSI	ITEM#	FINISH						PCS / MC	
Entrance	F109	CAT00	<b>US26D</b>	<b>US10B</b>	<b>US3</b>	<b>US10</b>	<b>US26</b>	<b>US4</b>	10	
		<b>Ⓢ</b> ICCAT00								
Entrance Push Button Lock	F82	CAT01	US26D	US10B	US3	US10	US26	US4		
		<b>Ⓢ</b> ICCAT01								
Store lock <b>Non Clutch</b> (keyed Dbl. cyl.)	F91	AT02	<b>US26D</b>	<b>US10B</b>	<b>US3</b>	<b>US10</b>	<b>US26</b>	<b>US4</b>		
		<b>Ⓢ</b> ICAT02		US10B	US3	US10	US26	US4		
Classroom	F84	CAT03		<b>US10B</b>	<b>US3</b>	<b>US10</b>	<b>US26</b>	<b>US4</b>		
		<b>Ⓢ</b> ICCAT03		US10B	US3	US10	US26	US4		
Communicating (keyed Dbl. cyl.)	F80	CAT04		<b>US10B</b>	<b>US3</b>	<b>US10</b>	<b>US26</b>	<b>US4</b>		
		<b>Ⓢ</b> ICCAT04		US10B	US3	US10	US26	US4		
Storeroom	F86	CAT05		<b>US10B</b>	<b>US3</b>	<b>US10</b>	<b>US26</b>	<b>US4</b>		
		<b>Ⓢ</b> ICCAT05		US10B	US3	US10	US26	US4		
Vestibule	F88	CAT06		<b>US10B</b>	<b>US3</b>	<b>US10</b>	<b>US26</b>	<b>US4</b>		
		<b>Ⓢ</b> ICCAT06								
Classroom / Intruder	F110	CAT07		US10B	US3	US10	US26	US4		
		<b>Ⓢ</b> ICCAT07								
Institution (keyed Dbl. cyl.)	F87	CAT09		<b>US10B</b>	<b>US3</b>	<b>US10</b>	<b>US26</b>	<b>US4</b>		
		<b>Ⓢ</b> ICCAT09		US10B	US3	US10	US26	US4		
Privacy	F76	CAT20		<b>US10B</b>	<b>US3</b>	<b>US10</b>	<b>US26</b>	<b>US4</b>		
Hospital Privacy	---	HCAT20		US10B	US3	US10	US26	US4		
Passage	F75	AT30		<b>US10B</b>	<b>US3</b>	<b>US10</b>	<b>US26</b>	<b>US4</b>		
Exit	F89	AT50		US26D	US10B	US3	US10	US26	US4	
Single Dummy	----	AT40		<b>US26D</b>	<b>US10B</b>	<b>US3</b>	<b>US10</b>	<b>US26</b>	<b>US4</b>	20

**Ⓢ** (IC) Indicates function available with **Best, Falcon and Arrow** Interchangeable Core. For IC Core see pages **L105 – L106**. For Keying see page **L115**.

## HEAVY DUTY CYLINDRICAL LEVERSETS WITH CLUTCH

### ANSI - A156.2, SERIES 4000, GRADE 1

Optional Interchangeable Core for **Best, Falcon and Arrow**

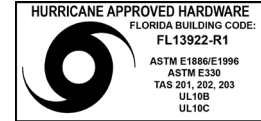
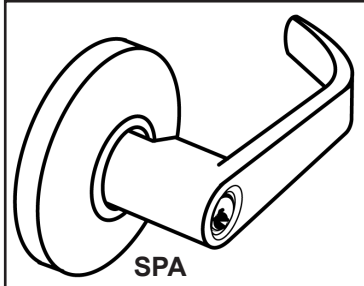

### STOCK ITEM IN BOLD.

NON-STOCK FINISH AND DESIGNS AVAILABLE WITH FACTORY LEAD TIME AND SUBJECT TO MINIMUM ORDER

FUNCTIONS	ANSI	ITEM#	FINISH						PCS / MC	
Entrance	F109	CSPA00	US26D	US10B	US3	US10	US26	US4	10	
		● ICCSPA00		US10B	US3	US10	US26	US4		
Entrance Push Button Lock	F82	CSPA01	US26D	US10B	US3	US10	US26	US4		
		● ICCSPA01	US26D	US10B	US3	US10	US26	US4		
Store lock Non Clutch (keyed Dbl. cyl.)	F91	SPA02	US26D	US10B	US3	US10	US26	US4		
		● ICSPA02		US10B	US3	US10	US26	US4		
Classroom	F84	CSPA03		US10B	US3	US10	US26	US4		
		● ICCSPA03		US10B	US3	US10	US26	US4		
Communicating (keyed Dbl. cyl.)	F80	CSPA04		US10B	US3	US10	US26	US4		
		● ICCSPA04		US10B	US3	US10	US26	US4		
Storeroom	F86	CSPA05		US10B	US3	US10	US26	US4		
		● ICCSPA05		US10B	US3	US10	US26	US4		
Vestibule	F88	CSPA06		US10B US10B	US3	US10	US26	US4		
		● ICCSPA06		US10B	US3	US10	US26	US4		
Classroom / Intruder	F110	CSPA07		US10B	US3	US10	US26	US4		
		● ICCSPA07		US10B	US3	US10	US26	US4		
Institution (keyed Dbl. cyl.)	F87	CSPA09		US10B	US3	US10	US26	US4		
		● ICCSPA09		US10B	US3	US10	US26	US4		
Privacy	F76	CSPA20		US10B	US3	US10	US26	US4		
Hospital Privacy	---	HCSA20		US10B	US3	US10	US26	US4		
Passage	F75	SPA30		US10B	US3	US10	US26	US4		
Exit	F89	SPA50		US26D	US10B	US3	US10	US26	US4	
Single Dummy	----	SPA40		US26D	US10B	US3	US10	US26	US4	20

● (IC) Indicates function available with Best, Falcon and Arrow Interchangeable Core. For IC Core see pages L105 – L106. For Keying see page L115.



## HEAVY DUTY CYLINDRICAL LEVERSETS WITH CLUTCH ANSI - A156.2, SERIES 4000, GRADE 1

● Optional Interchangeable Core for **Best, Falcon and Arrow**

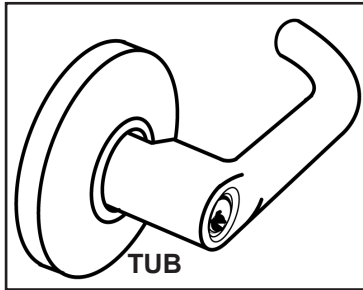

**LIFETIME WARRANTY**

**BHMA**  
CERTIFIED  
Be Safe. Be Secure. Look for the Mark.

**MEETS**  
The Buy American Act

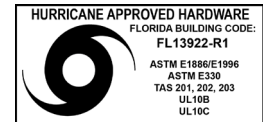

### STOCK ITEM IN BOLD.

NON-STOCK FINISH AND DESIGNS AVAILABLE WITH FACTORY LEAD TIME AND SUBJECT TO MINIMUM ORDER

FUNCTIONS	ANSI	ITEM#	FINISH						PCS / MC
Entrance	F109	CTUB00	<b>US26D</b>	<b>US10B</b>	<b>US3</b>	<b>US10</b>	<b>US26</b>	<b>US4</b>	10
		● ICCTUB00	US26D						
Entrance Push Button Lock	F82	CTUB01	<b>US26D</b>	US10B	US3	US10	US26	US4	
		● ICCTUB01	US26D						
Store lock Non Clutch (keyed Dbl. cyl.)	F91	TUB02	<b>US26D</b>	<b>US10B</b>	<b>US3</b>	<b>US10</b>	<b>US26</b>	<b>US4</b>	
		● ICTUB02		US10B	US3	US10	US26	US4	
Classroom	F84	CTUB03	<b>US26D</b>	<b>US10B</b>	<b>US3</b>	<b>US10</b>	<b>US26</b>	<b>US4</b>	
		● ICCTUB03		US10B	US3	US10	US26	US4	
Communicating (keyed Dbl. cyl.)	F80	CTUB04	<b>US26D</b>	<b>US10B</b>	<b>US3</b>	<b>US10</b>	<b>US26</b>	<b>US4</b>	
		● ICCTUB04		US10B	US3	US10	US26	US4	
Storeroom	F86	CTUB05	<b>US26D</b>	<b>US10B</b>	<b>US3</b>	<b>US10</b>	<b>US26</b>	<b>US4</b>	
		● ICCTUB05		US10B	US3	US10	US26	US4	
Vestibule	F88	CTUB06	<b>US26D</b>	<b>US10B</b>	<b>US3</b>	<b>US10</b>	<b>US26</b>	<b>US4</b>	
		● ICCTUB06	US26D						
Classroom / Intruder	F110	CTUB07	<b>US26D</b>	US10B	US3	US10	US26	US4	
		● ICCTUB07	US26D						
Institution (keyed Dbl. cyl.)	F87	CTUB09	<b>US26D</b>	<b>US10B</b>	<b>US3</b>	<b>US10</b>	<b>US26</b>	<b>US4</b>	
		● ICCTUB09	US26D	US10B	US3	US10	US26	US4	
Privacy	F76	CTUB20	<b>US26D</b>	<b>US10B</b>	<b>US3</b>	<b>US10</b>	<b>US26</b>	<b>US4</b>	
Hospital Privacy	---	HCTUB20		US10B	US3	US10	US26	US4	
Passage	F75	TUB30		<b>US10B</b>	<b>US3</b>	<b>US10</b>	<b>US26</b>	<b>US4</b>	
Exit	F89	TUB50	US26D	US10B	US3	US10	US26	US4	
Single Dummy	----	TUB40	<b>US26D</b>	<b>US10B</b>	<b>US3</b>	<b>US10</b>	<b>US26</b>	<b>US4</b>	20

● (IC) Indicates function available with Best, Falcon and Arrow Interchangeable Core. For IC Core see pages L105 – L106. For Keying see page L115.

## HEAVY DUTY CYLINDRICAL LEVERSETS WITH CLUTCH ANSI - A156.2, SERIES 4000, GRADE 1

Optional Full Size Interchangeable Core for **Corbin/Russwin, Sargent and Yale**

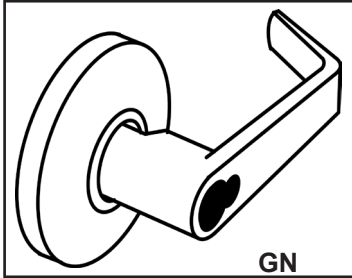

**LIFETIME WARRANTY**

**BHMA CERTIFIED**  
Be Safe. Be Secure. Look for the Mark.

**MEETS**  
The Buy American Act

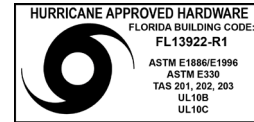

**STOCK ITEM IN BOLD.**  
NON-STOCK FINISH AND DESIGNS AVAILABLE WITH FACTORY LEAD TIME AND SUBJECT TO MINIMUM ORDER

**CORBIN/RUSSWIN (Large Format Interchangeable Core) 7 OR 6 PIN ONLY**

FUNCTIONS	ANSI	ITEM#	FINISH					PCS / MC	
Entrance	F109	Ⓜ RUSICCGN00	<b>US26D</b>	US10B	US3	US10	US26	US4	10
Classroom	F84	Ⓜ RUSICCGN03							
Communicating (keyed Dbl. cyl.)	F80	Ⓜ RUSICCGN04							
Storeroom	F86	Ⓜ RUSICCGN05							
Vestibule	F88	Ⓜ RUSICCGN06							
Classroom / Intruder	F110	Ⓜ RUSICCGN07							
Institution (keyed Dbl. cyl.)	F87	Ⓜ RUSICCGN09							
Dormitory (Non-Clutch)	F90	Ⓜ RUSICCGN101							

**SARGENT (Large Format Interchangeable Core) 6 PIN ONLY**

FUNCTIONS	ANSI	ITEM#	FINISH					PCS / MC	
Entrance	F109	Ⓜ SARICCGN00	<b>US26D</b>	US10B	US3	US10	US26	US4	10
Classroom	F84	Ⓜ SARICCGN03							
Communicating (keyed Dbl. cyl.)	F80	Ⓜ SARICCGN04							
Storeroom	F86	Ⓜ SARICCGN05							
Vestibule	F88	Ⓜ SARICCGN06							
Classroom / Intruder	F110	Ⓜ SARICCGN07							
Institution (keyed Dbl. cyl.)	F87	Ⓜ SARICCGN09							
Dormitory (Non-Clutch)	F90	Ⓜ SARICCGN101							

**YALE (Large Format Interchangeable Core) 6 PIN ONLY**

FUNCTIONS	ANSI	ITEM#	FINISH					PCS / MC	
Entrance	F109	Ⓜ YALICCGN00	<b>US26D</b>	US10B	US3	US10	US26	US4	10
Classroom	F84	Ⓜ YALICCGN03							
Communicating (keyed Dbl. cyl.)	F80	Ⓜ YALICCGN04							
Storeroom	F86	Ⓜ YALICCGN05							
Vestibule	F88	Ⓜ YALICCGN06							
Classroom / Intruder	F110	Ⓜ YALICCGN07							
Institution (keyed Dbl. cyl.)	F87	Ⓜ YALICCGN09							
Dormitory (Non-Clutch)	F90	Ⓜ YALICCGN101							

Ⓜ (IC) Indicates function available with Corbin / Russwin, Sargent, and Yale Full Size Interchangeable Core. For IC Core see page L106. For Keying see page L115.

## HEAVY DUTY CYLINDRICAL LEVERSETS WITH CLUTCH ANSI - A156.2, SERIES 4000, GRADE 1

⚙️ **Optional Full Size Interchangeable Core for SCHLAGE**

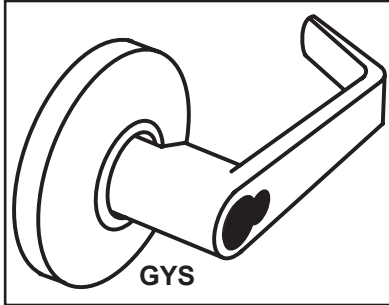

**STOCK ITEM IN BOLD.**  
 NON-STOCK FINISH AND DESIGNS AVAILABLE WITH FACTORY LEAD TIME AND SUBJECT TO MINIMUM ORDER

**SCHLAGE** (Large Format Interchangeable Core) **6 PIN ONLY**

FUNCTIONS	ANSI	ITEM#	FINISH						PCS / MC
			US26D	US10B	US3	US10	US26	US4	
Entrance	F109	⚙️ <b>ICGYS00</b>	US26D	US10B	US3	US10	US26	US4	10
Storeroom	F86	⚙️ <b>ICGYS05</b>							
Classroom	F84	⚙️ <b>ICGYS03</b>							
Communicating (keyed Dbl. cyl.)	F80	⚙️ <b>ICGYS04</b>							
Vestibule	F88	⚙️ <b>ICGYS06</b>		US10B					
Classroom/ Intruder	F110	⚙️ <b>ICGYS07</b>							
Institution (keyed Dbl. cyl.)	F87	⚙️ <b>ICGYS09</b>							
Dormitory (Non-Clutch)	F90	⚙️ <b>ICGYS101</b>							

⚙️ (IC) Indicates function available with Schlage Full Size Interchangeable Core. For IC Core see page L106. For Keying see page L115.

► **PACKAGING INCLUDES**

- UL Listed 2 3/4" Backset, 2 1/4" x 1 1/8" faceplate
- Standard "C", 6-pin cylinder
- ASA strike
- **For 2" up to 2 1/4" Thick Door Use Part # below.**

CGN214T00 - Entrance, CGN00	CGN214T05 - Storeroom, CGN05
GN214T02 - Store Lock, GN02	CGN214T09 - Institution, CGN09
CGN214T03 - Classroom, CGN03	CGN214T20 - Privacy, CGN20
CGN214T04 - Communicating, CGN04	GN214T30 - Passage, GN30
● <b>ICCGN214T00 - Entrance, ICCGN00</b>	Available on <b>AT, SPA &amp; TUB</b> Design. Use same Part No.
● <b>ICCGN214T03 - Classroom, ICCGN03</b>	
● <b>ICCGN214T05 - Storeroom, ICCGN05</b>	

► **KEYWAYS**

6-pin solid brass "C" keyway standard. Optional: Schlage E, Schlage C-K, Russwin D1-2-3-4, Corbin 59 / 60, Corbin-Russwin L4, Sargent LA-LB-LC, Falcon / Weiser E, Arrow A, Yale 8, Yale GA and Kwikset. Can also accept Medeco, Assa, Kaba and **Cal-Royal HSK** High Security Cylinders. See **page L115** for keying and Cylinder PART #.

► **MOUNT**

1 hole wooden mount  
Part # CGNMOUNT

► **ANTI MICROBIAL COATING**

Available on US26D finish only.

► **IC CORE, KEYING**

●● For IC Core see pages **L105-L106**. For Keying see page **L115**.

Prefix "**ANTB**" before **Part #**.

► **TACTILE / LEAD LINING**

- Lead Lining Part # **LEAD**
- Tactile Part # **TAC**

► **ELECTRIFIED**

*Available on Storeroom Only*



- Electrified **Part # ELEC**.  
Specify 12V or 24V, fail safe (SAF) or fail secure (SEC)

**STOCK ITEM IN BOLD.**  
**NON-STOCK FINISH AVAILABLE WITH FACTORY LEAD TIME AND**  
**SUBJECT TO MINIMUM ORDER**

ELECTRIFIED				
DESCRIPTION	ITEM #	FINISH		
FAIL SAFE OPTION 12V AC / DC	ECGN0512SAF	<b>US26D</b>	<b>US10B</b>	<b>US4</b>
	EICGN0512SAF		US10B	US4
	EICGYS0512SAF	US26D		
FAIL SECURE OPTION 12V AC / DC	ECGN0512SEC	<b>US26D</b>	<b>US10B</b>	<b>US4</b>
	EICGN0512SEC		US10B	US4
	EICGYS0512SEC	US26D		
FAIL SAFE OPTION 24V AC / DC	ECGN0524SAF	<b>US26D</b>	<b>US10B</b>	<b>US4</b>
	EICGN0524SAF		US10B	US4
	EICGYS0524SAF	US26D		
FAIL SECURE OPTION 24V AC / DC	ECGN0524SEC	<b>US26D</b>	<b>US10B</b>	<b>US4</b>
	EICGN0524SEC		US10B	US4
	EICGYS0524SEC	US26D		

► **ADDITIONAL PARTS FOR GENESYS SERIES**

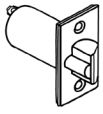
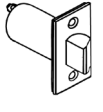
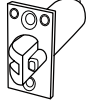
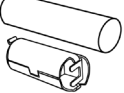
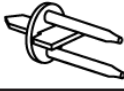
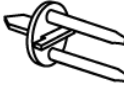
**Backsets:** UL listed 2 3/8", 2 1/4" x 1" Faceplate

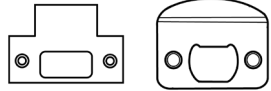
ILLUSTRATION	ITEM #	DESCRIPTION	FINISH
	GND238	CGN Series Dead Latch 2 3/8", 2 1/4" x 1" Faceplate	US3, 26D, 10B
	GNS238	CGN Series Spring Latch 2 3/8", 2 1/4" X 1" Faceplate	US3, 26D, 10B
	GND750	3/4" throw, anti-friction Dead Latch for pairs of fire doors, 2 1/4" x 1 1/8" Faceplate	US3, 26D, 10B, 10
	GEN5 EXT	5" Backset Extension Link	-----
	GEN334 EXT	3 3/4" Backset Extension Link	
<b>TAIL PIECE</b>			
	ICTP-01	6-pin Tail Piece for IC Genesys Series	
	ICTP-02	7 Pin Tail Piece for IC Genesys Series	
	ICTP-07	Tail Piece for Schlage Large Format IC Core	
<b>EXTRA UL LISTED BACKSET</b>			
	GND234	CGN Series 2 3/4" Dead latch, 2 1/4" x 1 1/8" Faceplate	US3, 26D, 10B
<b>STRIKES</b>			
	TS	T-Strike	US3, 26D, 10B, 26, 10, 4
	FLS	Full Lip Strike, Round Corner	

# CALYPSO Series

**EXTRA HEAVY DUTY CYLINDRICAL LEVERSETS**  
**ANSI - A156.2, SERIES 4000, GRADE 1**

**⌘ Optional Interchangeable Core for Best, Falcon and Arrow**



**LIFETIME WARRANTY**

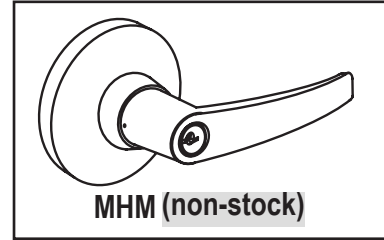
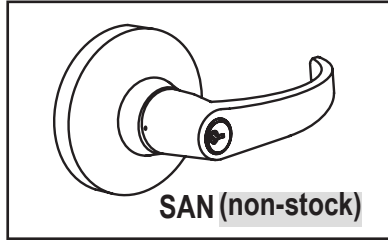
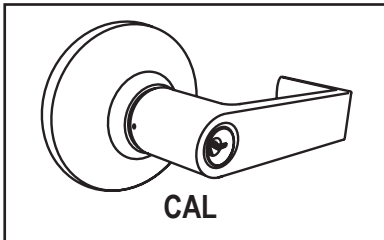

**When ordering:** "SAN" or "MHM" design **Example:** CAL00 Entrance in "SAN" design is SAN00 or in "MHM" design is MHM00

**STOCK ITEM IN BOLD**  
NON-STOCK FINISH AND DESIGNS AVAILABLE WITH FACTORY LEAD TIME AND SUBJECT TO MINIMUM ORDER.

FUNCTION	ANSI	ITEM #	FINISH	PCS / MC			
Entrance	F109	CAL00 <b>⌘ ICCAL00</b>	<b>US26D</b>	US10B, 3, 10, 26, 4  6			
Storelock	F91	CAL02 <b>⌘ ICCAL02</b>					
Classroom	F84	CAL03 <b>⌘ ICCAL03</b>					
Communicating	F80	CAL04 <b>⌘ ICCAL04</b>					
Storeroom	F86	CAL05 <b>⌘ ICCAL05</b>					
Vestibule	F88	CAL06 <b>⌘ ICCAL06</b>					
Classroom Intruder	F110	CAL07 <b>⌘ ICCAL07</b>					
Institution	F87	CAL09 <b>⌘ ICCAL09</b>					
Dormitory	F90	CAL101 <b>⌘ ICCAL101</b>					
Privacy	F76	CAL20					
Passage	F75	CAL30					
Dummy	----	CAL40			<b>50.00</b>	52.00	12

**⌘ (IC)** Indicates function available with **Best, Falcon and Arrow** Interchangeable Core. For IC Core see pages L105 – L106. For Keying see page L115.

► **PACKAGING INCLUDES**

UL Listed 2 3/4" Backset, 2 1/4" x 1 1/8" faceplate, Standard "C", 6-pin cylinder, ASA Strike

► **KEYWAYS**

6-pin solid brass "C" keyway standard. Optional: Schlage E, Schlage C-K, Russwin D1-2-3-4, Corbin 59 / 60, Corbin-Russwin L4, Sargent LA-LB-LC, Falcon / Weiser E, Arrow A, Yale 8, Yale GA and Kwikset. Can also accept Medeco, Assa, Kaba and **Cal-Royal HSK High Security Cylinders**. See **page L115** for keying and Cylinder Part #.

► **IC CORE, KEYING**

For IC Core see pages **L105-L106**. For Keying see page **L115**.

► **ANTI MICROBIAL COATING**

Available on US26D finish only.  
Prefix "**ANTB**" before **Part #**.

► **TACTILE / LEAD LINING**

- Lead Lining Part # **LEAD**
- Tactile Part # **TAC**

► **ADDITIONAL PARTS FOR CALYPSO SERIES**

**Backsets:** UL listed 2 3/8", 2 1/4" x 1 1/8" faceplate

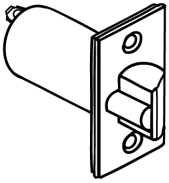
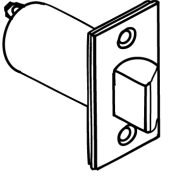
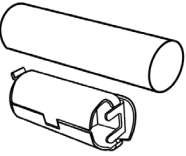
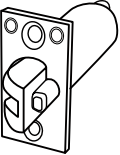
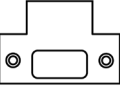
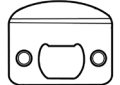
ILLUSTRATION	ITEM #	DESCRIPTION	FINISH
<b>EXTRA UL BACKSET</b>			
	CALSLD238	CAL Series Dead latch 2 3/8" 2 1/4" x 1 1/8" Faceplate	US26D
	CALDOR238	CAL101 Dormitory Dead latch 2 3/8" 2 1/4" x 1 1/8" Faceplate	US26D
	CALSLS238	CAL Series Spring Latch 2 3/8" 2 1/4" x 1 1/8" Faceplate	US26D
	CALSLP238	CAL Series Privacy Latch 2 3/8" 2 1/4" x 1 1/8" Faceplate	US26D
	CAL334 EXT	CAL Series 3 3/4" Extension Link <b>To be used with CALSLD238</b>	----
	CAL5 EXT	CAL Series 5" Extension Link	----
	CAL750	2 3/4" Backset, 2 1/4" x 1 1/8" faceplate, 3/4" throw, anti-friction Dead latch for pairs of fire doors	US26D
<b>STRIKES</b>			
	TS	T-Strike	US3, 26D, 10B, 26, 10, 4
	FLS	Full Lip Strike Round Corner	

# OMEGA GRB Series

## HEAVY DUTY CYLINDRICAL LEVERSETS

### ANSI - A156.2, SERIES 4000, GRADE 1

Ⓢ Optional Interchangeable Core for Best, Falcon and Arrow

 <small>3 HOUR FIRE RATED UL10C, UBC7-2-1997</small>	<b>LIFETIME WARRANTY</b>	<b>BHMA</b> <sup>TM</sup> <b>CERTIFIED</b> <small>Be Safe. Be Secure. Look for the Mark.</small>	<b>MEETS</b> <i>The Buy American Act</i>
--	--------------------------	--	---

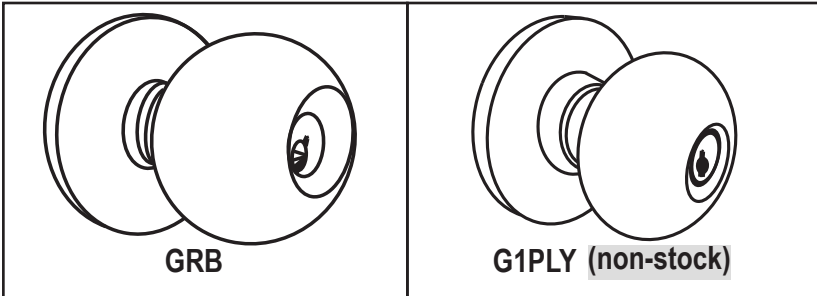

**When ordering:** "G1PLY" design **Example:** GRB00 Entrance in G1PLY design is G1PLY00

**STOCK ITEM IN BOLD**  
**NON-STOCK FINISH AND DESIGNS AVAILABLE WITH FACTORY LEAD TIME AND SUBJECT TO MINIMUM ORDER.**

FUNCTION	ANSI	ITEM #	FINISH			PCS / MC
Entrance	F109	Ⓢ GRB00 or <b>ICGRB00</b>	<b>US32D</b>	US3	US10B, 10, 4, 26	10
Storelock (keyed Dbl. cyl.)	F91	GRB02				
Classroom	F84	Ⓢ GRB03 or <b>ICGRB03</b>				
Communicating (keyed Dbl. cyl.)	F80	GRB04				
Storeroom	F86	Ⓢ GRB05 or <b>ICGRB05</b>				
Institution (keyed Dbl. cyl.)	F87	GRB09				
Privacy	F76	GRB20				
Passage	F75	GRB30				
Single Dummy	----	GRB40				

Ⓢ (IC) Indicates function available with **Best, Falcon and Arrow** Interchangeable Core. For IC Core see pages **L105 – L106**. For Keying see page **L115**.



► **PACKAGING INCLUDES**

UL Listed 2 3/4" Backset, 2 1/4" x 1 1/8" faceplate, Standard "C", 6-pin cylinder, ASA Strike

► **KEYWAYS**

6-pin solid brass "C" keyway standard. Optional: Schlage E, Schlage C-K, Russwin D1-2-3-4, Corbin 59 / 60, Corbin-Russwin L4, Sargent LA-LB-LC, Falcon / Weiser E, Arrow A, Yale 8, Yale GA and Kwikset. Can also accept Medeco, Assa, Kaba and **Cal-Royal HSK** High Security Cylinders. See **page L115** for keying and Cylinder PART #.

► **IC CORE, KEYING**

For IC Core see pages **L105-L106**. For Keying see page **L115**.

► **TACTILE / LEAD LINING**

- Lead Lining Part # **LEAD**
- Tactile Part # **TAC**

► **ADDITIONAL PARTS FOR OMEGA GRB SERIES**

**Backsets:** UL listed 2 3/8", 2 1/4" x 1 1/8" faceplate.

► **ANTI MICROBIAL COATING**

Available on US32D finish only.  
 Prefix "ANTB" before **Part #**.

► **ELECTRIFIED**

- Electrified **Part #** **ELEC**
- Specify 12V or 24V, fail safe (EL) or fail secure (EU)

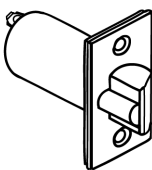
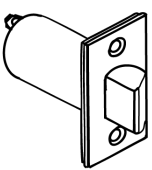
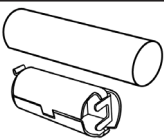
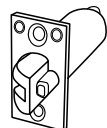
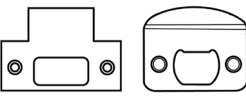
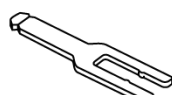
ILLUSTRATION	ITEM #	DESCRIPTION	FINISH
<b>EXTRA UL BACKSET</b>			
	CALSLD238	CAL Series Dead latch 2 3/8" 2 1/4" x 1 1/8" Faceplate	US26D
	CALDOR238	CAL101 Dormitory Dead latch 2 3/8" 2 1/4" x 1 1/8" Faceplate	
	CALSLS238	CAL Series Spring Latch 2 3/8" 2 1/4" x 1 1/8" Faceplate	
	CALSLP238	CAL Series Privacy Latch 2 3/8" 2 1/4" x 1 1/8" Faceplate	
	CAL334 EXT	CAL Series 3 3/4" Extension Link <b>To be used with CALSLD238</b>	----
	CAL5 EXT	CAL Series 5" Extension Link	----
	CAL750	2 3/4" Backset, 2 1/4" x 1 1/8" faceplate, 3/4" throw, anti-friction Dead latch for pairs of fire doors	US26D
<b>STRIKES</b>			
	TS	T-Strike	US3, 10B, 26, 10, 4
	FLS	Full Lip Strike	
<b>TAIL PIECE</b>			
	ICTP-09	Tail Piece for ICGRB	----

**CAL-ROYAL PRODUCTS, INC.  
COMPARISON CHART**

**GENESYS "CGN" AND CALYPSO "CAL" SERIES ( GRADE 1 CLUTCH LEVER )**

FUNCTION	ANSI #	CAL-ROYAL GENESYS & CALYPSO	SCHLAGE VANDLGARD	SARGENT CLUTCH	RUSSWIN CORBIN	PDQ	FALCON CLUTCH	YALE CLUTCH	HAGER
Entrance	F82 / F109	CGN00, CAL00	ND53 / ND92PD	10G05	CL3351	GT 116 / 182	T501	5407L	3450 / 3453
Storeroom	F86	CGN05, CAL05	ND80 / ND96PD	10G04	CL3357	GT 115	T581	5405L	3480
Classroom	F84	CGN03, CAL03	ND70S / ND94PD	10G37	CL3355	GT 148	T561	5408L	3470
Privacy	F76	CGN20, CAL20	ND40S	10U65	CL3320	GT 176	T301	5402L	3440
Passage	F75	GN30, CAL30	ND10S	10U15	CL3310	GT 126	T101	5401L	3410
Dummy	----	GN40, CAL40	ND170	U94	CL3350	GT 211 / 205	T12	455L	3417
Storelock / Double Cylinder	F91	GN02, CAL02	ND66PD	10G26	CL3382	GT 137	T371	5419L	----
Communication / Double Cylinder	F80	CGN04, CAL04	ND72PD	10G30	CL3362	GT 150	T391	5421L	----
Vestibule	F88	CGN06, CAL06	ND60PD	10G16	CL3372	GT 135	T381	5417L	----
Classroom Intruder	F110	CGN07, CAL07	ND75PD	10G38	CL3352	GT 148	T561	5418L	3495
Institution / Double Cylinder	F87	CGN09, CAL09	ND82PD	10G17	CL3332	GT 128	T411	5430L	----
Exit/Communicating	F89	GN50	ND25D	10G15-3	CL3380	GT 125	----	5428L	----
Dormitory	F90	CAL101	ND73PD	10G54	CL3375	GT 165	T571	5422L	3473

**PIONEER "SL" SERIES, EXPLORER "XP" SERIES ( GRADE 2 NON-CLUTCH LEVER )  
PIONEER "CSL" SERIES ( GRADE 2 CLUTCH LEVER )**

FUNCTION	ANSI #	CAL-ROYAL PIONEER SERIES	SCHLAGE NON-CLUTCH	SARGENT NON-CLUTCH	RUSSWIN CORBIN	PDQ	FFRNON TUBULAR NON-CLUTCH	YALE	HAGER
Entrance	F82 / F109	CSL00 / SL00	AL53	65G05	CL3851	SP / SK	W511	5307LN	3553
Storeroom	F109	SL01	AL50	----	CL3861	116	W501	---	3550
Classroom	F86	CSL05 / SL05	AL80	65G04	CL3857	115	W581	5305LN	3580
Privacy	F84	CSL03 / SL03	AL70	65G37	CL3855	148	W561	5308LN	3570
Passage	F76	SL30	AL10S	65U15	CL3810	126	W101	5301LN	3510
Dummy	----	40SL40	AL170	65U93	CL3850	211 / 205	W12	5355LN	3517
Exit / Communicating	F89/F111	SL50	AL25	N/A	CL3880	125	W161	5328LN	3525
Exit Communicating Keyed	F112	SL80	----	----	----	----	----	----	----
Patio	F77	SL10	----	----	CL3840	GP182	----	----	----

**HIL AND JHIL SERIES ( INTERCONNECTED GRADE 2 LEVER )**

FUNCTION	ANSI NO	CAL-ROYAL HIL SERES	SCHLAGE	FALCON	HAGER
Entrance - Single Locking	F95	HIL30, JHIL30	CS201	H2101	3710
Entrance - Double Locking	F97	HIL00, JHIL00	-	-	3753

Other functions available upon request and subject to minimum quantity: Storeroom, single / double dummy trim



# CAL-ROYAL PRODUCTS, INC.

## COMPARISON CHART

### GRADE 2 CYLINDRICAL LEVER ( SG DESIGN )

FUNCTION	ANSI #	CAL-ROYAL SG SERIES	SCHLAGE S	FALCON "Y" Dane	YALE 4300LN	PDQ SE	CORBIN RUSSWIN	HAGER 3600
Entrance	F82 / F109	SG00	S51PD	Y521	4307LN	SE-116	CL3751	3653
Storeroom	F86	SG05	S80PD	Y581	4305LN	SE-115	CL3759	3680
Classroom	F84	SG03	S70PD	Y561	4308LN	SE-148	CL3755	3670
Patio	F77	SG10	----	----	----	----	----	----
Privacy	F76	SG20	S40D	Y301	4302LN	SE-176	CL3720	3640
Passage	F75	SG30	S10D	Y101	4301LN	SE-126	CL3710	3610
Dummy	----	SG40	S170	Y12	4355LN	SE-211	CL3750	3617
Exit	F89	SG50	----	Y161	----	SE-125	CL3780	----

### GRADE 2 CYLINDRICAL LOCKSET, ORBIT STYLE ( BA & PLG DESIGNS )

FUNCTION	ANSI #	CAL-ROYAL BA SERIES	SCHLAGE A SERIES	CORBIN 5600	RUSSWIN 3300	SARGENT 6 LINE	YALE 5300	ARROW 151	PDQ SV	FED. NO.
Entrance	F82 / F109	BA00	A53PD	5651	CK4251	6G05	5307	151	SV116	160A
Privacy	F76-2	BA20	A40S	5620	CK4220	6U65	----	157	SV176	160L
Passage	F75-2	BA30	A10S	5610	CK4210	6U15	5301	156	SV126	160N
Storeroom	F86-2	BA05	A80PD	5657	CK4257	6G04	5305	151F	SV115	160D
Classroom	F84-2	BA03	A70PD	5655	CK4255	6G37	5308	151S	SV148	160R
Double Cyl	----	BA04	A66D	----	CK4262	----	5316	----	SV137	----
Sgl Dummy	F79-2	BA40	A170	½ DT	CK4250	6U93	355	125	SV211	----
Storage	F91	BA02	----	----	CK4282	----	----	----	----	----
Institution	F87	BA09	----	----	CK4232	----	----	----	----	----
Exit	F89	BA50	A25D	----	----	6G15-3	5328	156CB	SV125	----

# TUSCANY Series

Clutch Mechanism, Optional Thru Bolt Installation  
ANSI - A156.2, Series 4000, Grade 2

Ⓜ Optional Interchangeable Core for **Best, Falcon and Arrow**

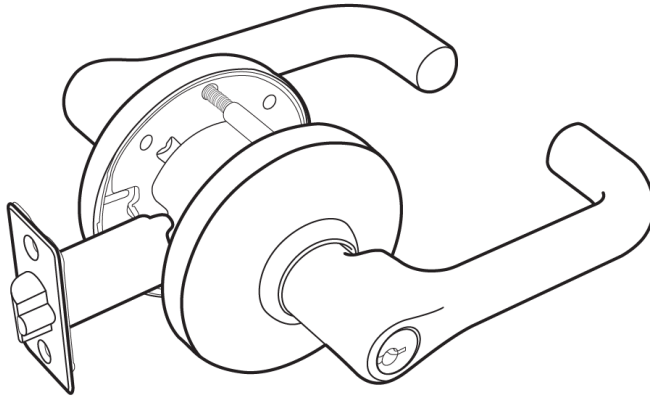

**MEETS**  
*The Buy American Act*







**STOCK ITEM IN BOLD**  
NON-STOCK FINISH AND DESIGNS AVAILABLE WITH FACTORY LEAD TIME AND SUBJECT TO MINIMUM ORDER.

FUNCTIONS	ANSI	ITEM #	FINISH						PCS / MC						
Entrance	F109	CTUSL00	<b>US26D</b>	US10B	US3	US10	US26	US4	10						
		Ⓜ ICCTUSL00													
Entrance Push Button Lock	F82	CTUSL01													
Classroom	F84	CTUSL03													
		Ⓜ ICCTUSL03													
Storeroom	F86	CTUSL05													
		Ⓜ ICCTUSL05													
Privacy	F76	CTUSL20													
Passage	F75	TUSL30													
Exit	F89	TUSL50													
Single Dummy	----	TUSL40						20							

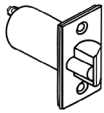
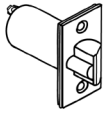
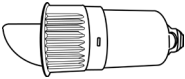
Ⓜ (IC) Indicates function available with **Best, Falcon and Arrow** Interchangeable Core. For IC Core see pages L105 – L106. For Keying see page L115.

► **ADDITIONAL PARTS FOR TUSCANY SERIES**

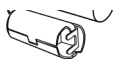
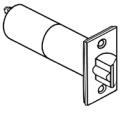
**Backsets:** UL listed 2 3/8", (2 1/4" x 1") faceplate.

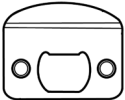
ILLUSTRATION	ITEM #	DESCRIPTION	FINISH
	ULSLD238	SL Series UL-listed Dead Latch 2 3/8" 2 1/4" x 1" Faceplate	US3, 26D, 10B, 10, 26
	ULSLS238	SL Series UL-listed Spring Latch 2 3/8" 2 1/4" x 1" Faceplate	US26D, 10B, 10, 26
	SLDRI-1	2 3/4" Entrance, Drive-in Latch bolt for G2 Lockset	ZINC
	SLDRI-2	2 3/4" Privacy / Passage, Drive-in Latch bolt for G2 Lockset	
	SLDRI-4	2 3/8" Entrance, Drive-in Latch bolt for G2 Lockset	
	SLDRI-5	2 3/8" Privacy / Passage, Drive-in Latch bolt for G2 Lockset	
<b>EXTRA UL LISTED BACKSET</b>			
	ULSLD234	SL Series Dead Latch 2 3/4" 2 1/4" x 1 1/8" Faceplate	US3, 26D, 10B, 10, 26
	ULSLS234	SL Series Spring Latch 2 3/4" 2 1/4" x 1 1/8" Faceplate	US3, 26D, 10B, 10, 26
<b>3 3/4", 5" UL LISTED BACKSET</b>			
	SL5	5" UL listed Extension Link	----
	SLD334	3 3/4" Dead latch, 2 1/4" x 1 1/8" Faceplate	US3, 26D, 10B
	SLS334	3 3/4" Spring Latch, 2 1/4" x 1 1/8" Faceplate	US3, 26D, 10B
<b>STRIKES</b>			
	TS	T-Strike	US3, 26D, 10B, 10, 26, 15, 4
	FLS	Full lip strike	US3, 26D, 10B, 10, 26, 15, 4, 5

# CRCODE200 Series

**GRADE 2, MECHANICAL STAND ALONE PUSH BUTTON LOCK AND EXIT DEVICE TRIM WITH BREAKAWAY LEVER FEATURE**

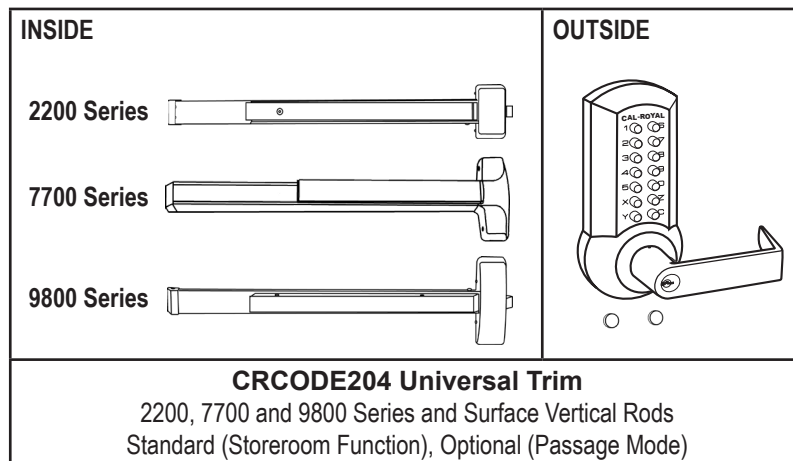
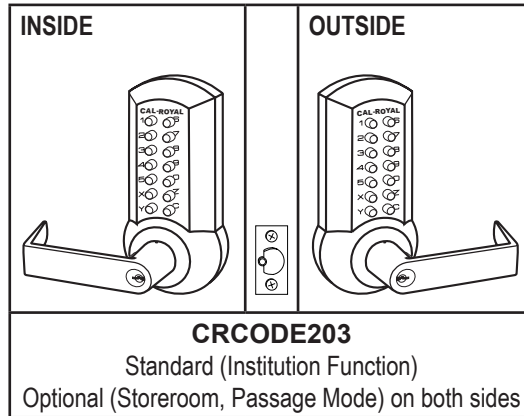
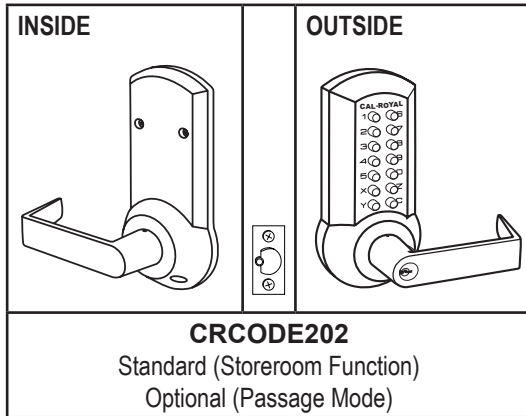

FUNCTION	ITEM #	FINISH		PCS / MC
Mechanical Easy Code Change Lock with 2 3/4" backset latchbolt Door Thickness: 1 3/8" - 2 1/4"	CRCODE202			8
Double Coded Easy Code Change Lock with 2 3/4" backset latchbolt Door Thickness: 1 3/8" - 1 3/4"	CRCODE203	US26D	US10B	8
Mechanical Easy Code Change Exit Trim for 2200, 7700 and 9800 Series Exit Device Door Thickness: 1 3/4" - 2"	CRCODE204			8
<b>ACCESSORIES</b>				
CRCODE200 Series Dead latch 2 3/8" 2 1/4" x 1" Faceplate (for CRCODE-202 and 203)	CRSLD	US26D	---	1
Easy Code Change Key	EZCHKEY	BLUE	---	1

► For Keying see page L115.

## PIONEER SL Series

### HEAVY DUTY CYLINDRICAL LEVERSETS

#### ANSI - A156.2, Series 4000, Grade 2

Optional Interchangeable Core for **Best, Falcon and Arrow**

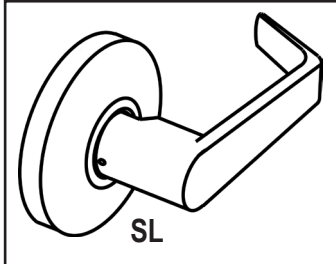

<p>3 HOUR FIRE RATED UL10C, UBC7-2-1997</p>	<p><b>LIFETIME WARRANTY</b></p>	<p><b>BHMA</b> CERTIFIED</p> <p>Be Safe. Be Secure. Look for the Mark.</p>	<p><b>MEETS</b> The Buy American Act</p>
---	---------------------------------	--	--

HURRICANE APPROVED HARDWARE  
FLORIDA BUILDING CODE:  
FL13922-R1  
ASTM E1886/E1996  
ASTM E530  
TAS 201, 202, 203  
UL10B  
UL10C

**STOCK ITEM IN BOLD**

NON-STOCK FINISH AND DESIGNS AVAILABLE WITH FACTORY LEAD TIME AND SUBJECT TO MINIMUM ORDER.

FUNCTIONS	ANSI	ITEM #	FINISH			PCS / MC
Entrance	F109	SL00 <b>ICSL00</b>	<b>US26D</b>	US3	US10BE, 10, 26, 4, 15, 5	US1
Combination Entrance and Single Cylinder Deadbolt -- KA/2 packed together	<b>NEW ITEM</b>	SL00 / T220		---	---	---
Storeroom	F91	SL05 <b>ICSL05</b>		US3	US10BE, 10, 26, 4, 15, 5	US1
Classroom	F84	SL03 <b>ICSL03</b>		US3	US10BE, 10, 26, 4, 15, 5	US1
Entrance Push Button Lock	F82	SL01 <b>ICSL01</b>	US26D	US3	US10BE, 10, 26, 4, 15, 5	10
Exit Lock / Connecting Room with key	---	SL80 <b>ICSL80</b>	<b>US26D</b>	US3	US10BE, 10, 26, 4, 15, 5	
			US26D	US3	US10BE, 10, 26, 4, 15, 5	
Dormitory / Assisted Living	F90	SL101 <b>ICSL101</b>	<b>US26D</b>	US3	US10BE, 10, 26, 4, 15, 5	
Privacy (see below for split FINISH)	F76	SL20	<b>US26D</b>	US3	US10BE, 10, 26, 4, 15, 5	US1
				US3	US10BE, 10, 26, 4, 15, 5	US1
Patio	F77	SL10		US3	US10BE, 10, 26, 4, 15, 5	US1
Passage	F75	SL30				
Exit	F89	SL50				
Single Dummy	---	SL40		US3	US10BE, 10, 26, 4, 15, 5	US1
						20

**(IC)** Indicates function available with **Best, Falcon and Arrow** Interchangeable Core. For IC Core see pages L105 – L106. For Keying see page L115.

► **SPLIT FINISH FOR PRIVACY FUNCTION**

ILLUSTRATION	ITEM #	FUNCTIONS	ANSI	PCS / MC
<p>SL20</p>	SL20 US3 / 26 (Inside)	Privacy	F76	10
	SL20 US10B / 26 (Inside)			
	SL20 US4 / 26D (Inside)			
	SL20 US4 / 26 (Inside)			
	SL20 US4 / 3 (Inside)			
	SL20 US3 / 26D (Inside)			
	SL20 US10B / 26D (Inside)			

## PIONEER RL & AG Series

### HEAVY DUTY CYLINDRICAL LEVERSETS

ANSI - A156.2, Series 4000, Grade 2

Optional Interchangeable Core for **Best, Falcon and Arrow**

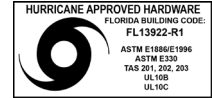
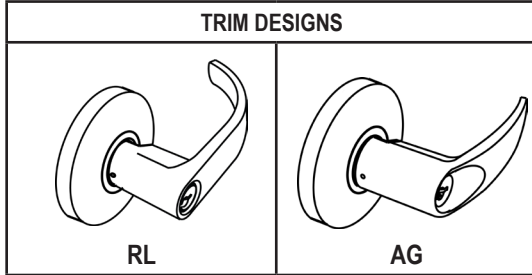

### STOCK ITEM IN BOLD

NON-STOCK FINISH AND DESIGNS AVAILABLE WITH FACTORY LEAD TIME AND SUBJECT TO MINIMUM ORDER.

FUNCTIONS	ANSI	ITEM #		FINISH			PCS / MC	
Entrance	F109	RL00	AG00	US26D	US3	US10BE, 10, 26, 4, 15	US1	
		<b>ICRL00</b>	<b>ICAG00</b>		US3	US10BE, 10, 26, 4, 15	US1	
Storeroom	F91	RL05	AG05		US3	US10BE, 10, 26, 4, 15	US1	
		<b>ICRL05</b>	<b>ICAG05</b>		US3	US10BE, 10, 26, 4, 15	US1	
Classroom	F84	RL03	AG03		US3	US10BE, 10, 26, 4, 15	US1	
		<b>ICRL03</b>	<b>ICAG03</b>		US3	US10BE, 10, 26, 4, 15	US1	
Entrance Push Button Lock	F82	RL01	AG01		US26D	US3	US10BE, 10, 26, 4, 15	10
		<b>ICRL01</b>	<b>ICAG01</b>		US26D	US3	US10BE, 10, 26, 4, 15	
Exit Lock / Connecting Room with key	---	RL80	AG80	US26D	US3	US10BE, 10, 26, 4, 15	US1	
		<b>ICRL80</b>	<b>ICAG80</b>	US26D	US3	US10BE, 10, 26, 4, 15		
Dormitory / Assisted Living	F90	RL101	AG101	US26D	US3	US10BE, 10, 26, 4, 15	US1	
		<b>ICRL101</b>	<b>ICAG101</b>	US26D	US3	US10BE, 10, 26, 4, 15		
Privacy (see below for split FINISH)	F76	RL20	AG20	US26D	US3	US10BE, 10, 26, 4, 15	US1	
Patio	F77	RL10	AG10		US3	US10BE, 10, 26, 4, 15	US1	
Passage	F75	RL30	AG30		US3	US10BE, 10, 26, 4, 15	US1	
Exit	F89	RL50	AG50			US3		US10BE, 10, 26, 4, 15
Single Dummy	---	RL40	AG40				20	

(IC) Indicates function available with **Best, Falcon and Arrow** Interchangeable Core. For IC Core see pages L105 – L106. For Keying see page L115.

#### ► SPLIT FINISH FOR PRIVACY FUNCTION

ILLUSTRATION	ITEM #	FUNCTIONS	ANSI	PCS / MC
<p>RL20</p>	RL20 or AG20 US3 / 26 (Inside)	Privacy	F76	10
	RL20 or AG20 US10B / 26 (Inside)			
	RL20 or AG20 US4 / 26D (Inside)			
	RL20 or AG20 US4 / 26 (Inside)			
	RL20 or AG20 US4 / 3 (Inside)			
	RL20 or AG20 US3 / 26D (Inside)			
	RL20 or AG20 US10B / 26D (Inside)			



## PIONEER CSL, CRL & CAG CLUTCH HEAVY DUTY CYLINDRICAL LEVERSETS WITH CLUTCH ANSI - A156.2, Series 4000, Grade 2

Optional Interchangeable Core for **Best, Falcon and Arrow**



**LIFETIME WARRANTY**

**BHMA**  
CERTIFIED  
Be Safe. Be Secure. Look for the Mark.

**MEETS**  
*The Buy American Act*

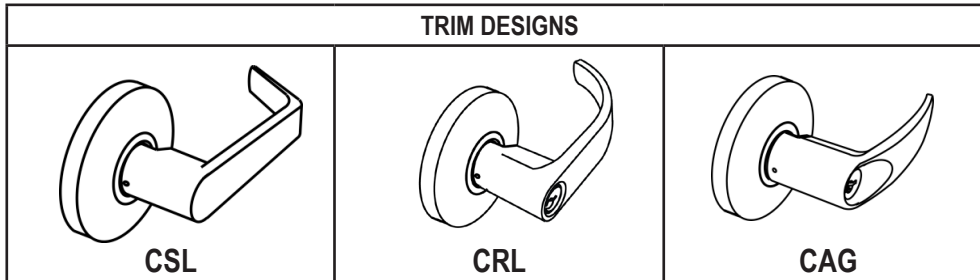

**STOCK ITEM IN BOLD**  
NON-STOCK FINISH AND DESIGNS AVAILABLE WITH FACTORY LEAD TIME AND SUBJECT TO MINIMUM ORDER.

FUNCTIONS	ANSI	ITEM #	FINISH			PCS / MC
Entrance	F109	CSL00	US26D	US3	US10BE	US10, 26, 4, 15, 5
		● IC CSL00		US3	US10BE	
Storeroom	F91	CSL05	US26D	US3	US10BE	
		● IC CSL05	US26D	US3	US10BE	
Classroom	F84	CSL03	US26D	US3	US10BE	
		● IC CSL03	US26D	US3	US10BE	
Privacy	F76	CSL20	US26D	US3	US10BE	

FUNCTIONS	ANSI	ITEM #		FINISH		PCS / MC
Entrance	F109	CRL00	CAG00	US26D, 3	US10BE, 10, 26, 4, 15, 5	10
		● IC CRL00	● IC CAG00	US26D, 3	US10BE, 10, 26, 4, 15, 5	
Storeroom	F91	CRL05	CAG05	US26D, 3	US10BE, 10, 26, 4, 15, 5	
		● IC CRL05	● IC CAG05	US26D, 3	US10BE, 10, 26, 4, 15, 5	
Classroom	F84	CRL03	CAG03	US26D, 3	US10BE, 10, 26, 4, 15, 5	
		● IC CRL03	● IC CAG03	US26D, 3	US10BE, 10, 26, 4, 15, 5	
Privacy	F76	CRL20	CAG20	US26D, 3	US10BE, 10, 26, 4, 15, 5	

● (IC) Indicates function available with **Best, Falcon and Arrow** Interchangeable Core. For IC Core see pages L105 – L106. For Keying see page L115.

► **PACKAGING INCLUDES**

UL Listed 2 3/4" Backset, 2 1/4" x 1 1/8" faceplate ASA Strike

► **KEYWAYS**

6-pin solid brass "C" keyway standard. Optional: Schlage E, Schlage C-K, Russwin D1-2-3-4, Corbin 59 / 60, Arrow A, Corbin-Russwin L4, Sargent LA-LB-LC, Falcon / Weiser E, Yale 8, Yale GA and Kwikset. Can also accept Medeco, Assa, Kaba and **Cal-Royal HSK** High Security Cylinders. See page L115 for Keying and Cylinder PART #.

► **IC CORES, KEYING**



For IC Core see pages L105 - L106.  
For Keying see page L115.

► **TACTILE / LEAD LINING**

Lead Lining Part # **LEAD**  
Tactile Part # **TAC**

► **ADDITIONAL PARTS FOR PIONEER SERIES**

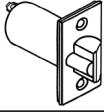
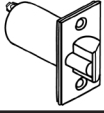
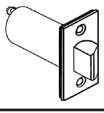
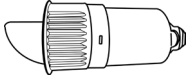
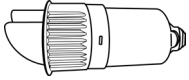
Backsets: UL listed 2 3/8", (2 1/4" x 1") faceplate

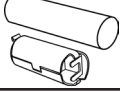
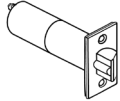
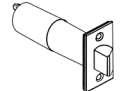
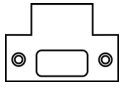
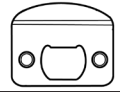
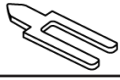
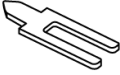
ILLUSTRATION	ITEM #	DESCRIPTION	FINISH
	ULSLD238	SL Series UL-listed Dead Latch 2 3/8" 2 1/4" x 1" Faceplate	US3, 26D, 10B, 10, 26
	ULSLS238	SL Series UL-listed Spring Latch 2 3/8" 2 1/4" x 1" Faceplate	US26D, 10B, 10, 26
	ULSGPA238	2 3/8" UL-listed Dead Latch, 2 1/4" x 1" Faceplate ( for SG10, SL10 Patio Function and SL101 Dormitory/Assisted Living Function )	US26D
	SLDRI-1	2 3/4" Entrance, Drive-in Latch bolt for G2 Lockset	ZINC
	SLDRI-2	2 3/4" Privacy / Passage, Drive-in Latch bolt for G2 Lockset	
	SLDRI-4	2 3/8" Entrance, Drive-in Latch bolt for G2 Lockset	
	SLDRI-5	2 3/8" Privacy / Passage, Drive-in Latch bolt for G2 Lockset	
<b>EXTRA UL LISTED BACKSET</b>			
	ULSLD234	SL Series Dead Latch 2 3/4" 2 1/4" x 1 1/8" Faceplate	US3, 26D, 10B, 10, 26
	ULSLS234	SL Series Spring Latch 2 3/4" 2 1/4" x 1 1/8" Faceplate	US3, 26D, 10B, 10, 26
<b>3 3/4", 5" UL LISTED BACKSET</b>			
	SL5	5" UL listed Extension Link	---
	SLD334	3 3/4" Dead latch, 2 1/4" x 1 1/8" Faceplate	US3, 26D, 10B
	SLS334	3 3/4" Spring Latch, 2 1/4" x 1 1/8" Faceplate	US3, 26D, 10B
<b>STRIKES</b>			
	TS	T-Strike	US3, 26D, 10B, 10, 26, 15, 4
	FLS	Full lip strike	US3, 26D, 10B, 10, 26, 15, 4, 5
<b>TAIL PIECE</b>			
	ICTP-03	6-pin Tail Piece for IC Pioneer Series	---
	ICTP-04	7 Pin Tail Piece for IC Pioneer Series	

## COMMANDER COM (CLUTCH) Series

### HEAVY DUTY CYLINDRICAL LEVERSETS WITH CLUTCH

#### ANSI - A156.2, Series 4000, Grade 2

With Interchangeable Core to accept **Schlage Full Size** format OEM Interchangeable Core Cylinder

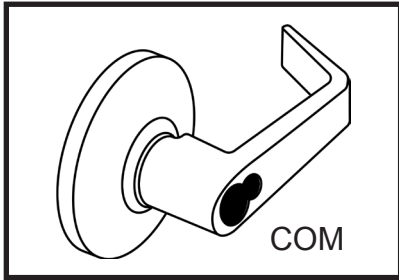

**LIFETIME WARRANTY**

**MEETS**  
*The Buy American Act*

**STOCK ITEM IN BOLD**  
NON-STOCK FINISH AND DESIGNS AVAILABLE WITH FACTORY LEAD TIME AND SUBJECT TO MINIMUM ORDER.

FUNCTIONS	ANSI	ITEM #	FINISH	PCS / MC		
Entrance	F109	ICCOM00	US26D, 3	US10B	US10, 26, 4, 5	10
Storeroom	F86	ICCOM05				
Classroom	F84	ICCOM03				

\*\*\*Use SL Pioneer series lockset for interior locks. For IC Core see page L106. For Keying see page L115.

► **PACKAGING INCLUDES**

- UL Listed 2 3/4" Backset, 2 1/4" x 1 1/8" faceplate
- Less cylinder
- ASA Strike

► **TACTILE / LEAD LINING**

- Lead Lining Part # LEAD
- Tactile Part # TAC

► **ADDITIONAL PARTS**

Backsets: UL listed 2 3/8", 2 1/4" x 1 1/8" Faceplate,

ILLUSTRATION	ITEM #	DESCRIPTION	FINISH
	GND238	CGN Series UL-listed Dead Latch 2 3/8"	US3, 26D, 10B, 26
	GND750	2 3/4" x 1 1/8" x 3/4" throw, anti-friction Dead latch for pairs of fire doors	US3, 26D, 10B, 10
	SLDRI-1	2 3/4" Entrance, Drive-in Latch bolt for G2 Lockset	ZINC
	SLDRI-4	2 3/8" Entrance, Drive-in Latch bolt for G2 Lockset	ZINC
<b>EXTRA UL LISTED BACKSET</b>			
	GND234	CGN Series Dead Latch 2 3/4"	US3, 26D, 10B, 26
	GEN5 EXT	5" Backset Extension Link	----
<b>STRIKES</b>	TS	T-Strike	US3, 26D, 10B, 26, 10, 4
	FLS	Full lip strike	US3, 26D, 10B, 26, 10, 4, 5
<b>TAIL PIECE</b>			
	ICTP07	Tail piece for Schlage Large format IC Core	----

# EXPLORER XP Series

## HEAVY DUTY CYLINDRICAL LEVERSETS

### ANSI - A156.2, Series 4000, Grade 2

Optional Interchangeable Core for **Best, Falcon and Arrow**

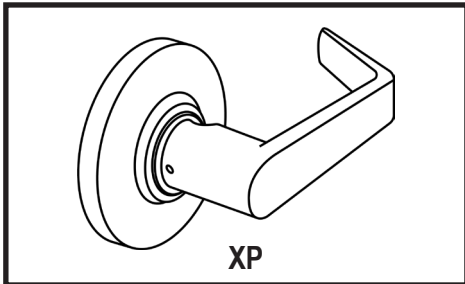

 <small>3 HOUR FIRE RATED UL10C, UBCT-2-1997</small>	<b>LIFETIME WARRANTY</b>	<b>BHMA™</b> <b>CERTIFIED</b> <small>Be Safe. Be Secure. Look for the Mark.</small>	<b>MEETS</b> <i>The Buy American Act</i>
--	--------------------------	---	---

<b>STOCK ITEM IN BOLD</b>							
<small>NON-STOCK FINISH AND DESIGNS AVAILABLE WITH FACTORY LEAD TIME AND SUBJECT TO MINIMUM ORDER.</small>							
FUNCTIONS	ANSI	ITEM #	FINISH				PCS / MC
Entrance	F109	XP00	<b>US26D</b>	US3	<b>US10B, 10, 26, 4</b>	US5,15	10
		●ICXP00		US3	US10B, 10, 26, 4		
Storeroom	F91	XP05		US3	<b>US10B, 10, 26, 4</b>		
		●ICXP05		US3	US10B, 10, 26, 4		
Classroom	F84	XP03		US3	<b>US10B, 10, 26, 4</b>		
		●ICXP03		US3	US10B, 10, 26, 4		
Privacy (See below for split FINISH)	F76	XP20		US3	<b>US10B, 10, 26, 4</b>		
Hospital Privacy	---	HXP20		US3	US10B, 10, 26, 4		
Passage	F75	XP30		<b>US3</b>	<b>US10B, 10, 26, 4</b>		
Exit	F89	XP50					
Single Dummy	----	XP40	20				

● (IC) Indicates function available with **Best, Falcon and Arrow** Interchangeable Core. For IC Core see pages L105 – L106. For Keying see page L115.

◆ **SPLIT FINISH FOR PRIVACY FUNCTION**

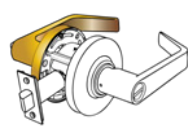
ILLUSTRATION	ITEM #	FUNCTIONS	ANSI	FINISH	PCS / MC
	XP20	Privacy	F76	US3 / 26D (Inside)	10
				US4 / 26 (Inside)	
				US10B / 26 (Inside)	
				US4 / 26D (Inside)	

## EXPLORER XPRL Series

### HEAVY DUTY CYLINDRICAL LEVERSETS

### ANSI - A156.2, SERIES 4000, GRADE 2

Optional Interchangeable Core for **Best, Falcon and Arrow**

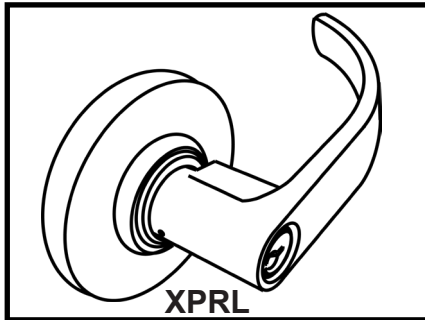

**LIFETIME WARRANTY**

**BHMA CERTIFIED**  
Be Safe. Be Secure. Look for the Mark.

**MEETS**  
*The Buy American Act*

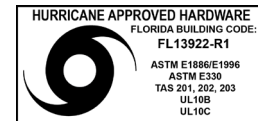

**STOCK ITEM IN BOLD**  
NON-STOCK FINISH AND DESIGNS AVAILABLE WITH FACTORY LEAD TIME  
AND SUBJECT TO MINIMUM ORDER.

FUNCTIONS	ANSI	ITEM #	FINISH		US3	US10,4 26,15	PCS / MC
Entrance	F109	XPRL00	<b>US26D</b>	<b>US10B</b>			
		● ICXPRL00	US26D	US10B			
Storeroom	F91	XPRL05	<b>US26D</b>	<b>US10B</b>			
		● ICXPRL05	US26D	US10B			
Classroom	F84	XPRL03	<b>US26D</b>	<b>US10B</b>			
		● ICXPRL03	US26D	US10B			
Privacy (See below for split FINISH)	F76	XPRL20	<b>US26D</b>	<b>US10B</b>			
Hospital Privacy	---	HXPRL20		US10B			
Passage	F75	XPRL30		<b>US10B</b>			
Exit	F89	XPRL50					
Single Dummy	----	XPRL40			20		

● (IC) Indicates function available with **Best, Falcon and Arrow** Interchangeable Core. For IC Core see pages L105 – L106.  
For Keying see page L115.

◆ **SPLIT FINISH FOR PRIVACY FUNCTION**

ILLUSTRATION	ITEM #	FUNCTIONS	ANSI	FINISH	PCS / MC
	XPRL20	Privacy	F76	US3 / 26D (Inside)	10
				US4 / 26 (Inside)	
				US10B / 26 (Inside)	
				US4 / 26D (Inside)	

## EXPLORER CXP, CXPRL CLUTCH

### HEAVY DUTY CYLINDRICAL LEVERSETS WITH CLUTCH

ANSI - A156.2, Series 4000, Grade 2

Optional Interchangeable Core for **Best, Falcon and Arrow**

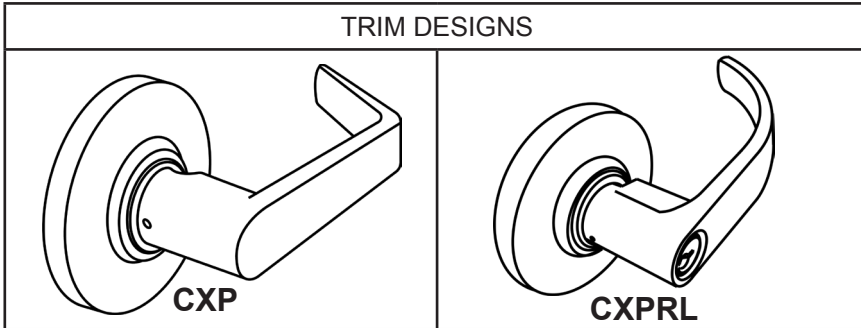

**MEETS**  
*The Buy American Act*

#### STOCK ITEM IN BOLD

NON-STOCK FINISH AND DESIGNS AVAILABLE WITH FACTORY LEAD TIME  
AND SUBJECT TO MINIMUM ORDER.

FUNCTIONS	ANSI	ITEM #	US26D	US10B	US3	US10, 26, 4, 15, 5	PCS / MC
Entrance	F109	CXP00	<b>US26D</b>	<b>US10B</b>	US3	US10, 26, 4, 15, 5	10
		ⓈICXP00	US26D	US10B			
Storeroom	F91	CXP05	<b>US26D</b>	<b>US10B</b>			
		ⓈICXP05	US26D	US10B			
Classroom	F84	CXP03	<b>US26D</b>	<b>US10B</b>			
		ⓈICXP03	US26D	US10B			
Privacy	F76	CXP20	<b>US26D</b>	<b>US10B</b>			
Hospital Privacy	---	HCXP20	<b>US26D</b>	US10B			

FUNCTIONS	ANSI	ITEM #	US26D	US10B	US3	US10, 26, 4, 15, 5	PCS / MC
Entrance	F109	CXPRL00	<b>US26D</b>	<b>US10B</b>	US3	US10, 26, 4, 15, 5	10
		ⓈICXPRL00	US26D	US10B			
Storeroom	F91	CXPRL05	<b>US26D</b>	<b>US10B</b>			
		ⓈICXPRL05	US26D	US10B			
Classroom	F84	CXPRL03	<b>US26D</b>	<b>US10B</b>			
		ⓈICXPRL03	US26D	US10B			
Privacy	F76	CXPRL20					
Hospital Privacy	---	HCXPRL20	<b>US26D</b>				

Ⓢ (IC) Indicates function available with **Best, Falcon and Arrow** Interchangeable Core. For IC Core see pages L105 – L106. For Keying see page L115.

► **PACKAGING INCLUDES**

- UL Listed 2 3/4" Backset with 2 1/4" x 1" Faceplate, Square corner, packed with 1/8" Filler for 1 1/8" width
- Standard "C", 6-pin cylinder
- ASA Strike

► **TACTILE / LEAD LINING**

- Lead Lining Part # **LEAD**
- Tactile Part # **TAC**

► **MOUNT**

- 2 hole wooden mount
- Part # **SLMOUNT**

► **IC CORES, KEYING**





For IC Core see pages **L105 – L106**. For Keying see page **L115**.

► **KEYWAYS**

6-pin solid brass "C" keyway standard. Optional: Schlage E, Schlage C-K, Russwin D1-2-3-4, Corbin 59 / 60, Corbin-Russwin L4, Sargent LA-LB-LC, Falcon / Weiser E, Arrow A, Yale 8, Yale GA and Kwikset. Can also accept Medeco, Assa, Kaba and **Cal-Royal HSK** High Security Cylinders. See **page L115** for keying and Cylinder PART #.

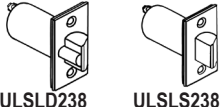
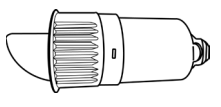
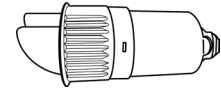
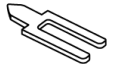
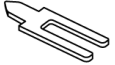
► **ADDITIONAL PARTS FOR EXPLORER SERIES**

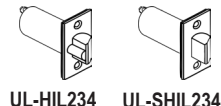
**Backsets:** UL listed 2 3/8", (2 1/4" x 1") faceplate.

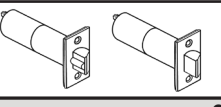
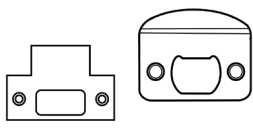
ILLUSTRATION	ITEM#	DESCRIPTION	FINISH
 ULSLD238    ULSLS238	ULSLD238	XP Series UL-listed Dead Latch 2 3/8" 2 1/4" x 1" Faceplate	US3, 26D, 10B, 10, 26
	ULSLS238	XP Series UL-listed Spring Latch 2 3/8" 2 1/4" x 1" Faceplate	
	SLDRI-1	2 3/4" Entrance, Drive-in Latch bolt for G2 Lockset	ZINC
	SLDRI-2	2 3/4" Privacy / Passage, Drive-in Latch bolt for G2 Lockset	
	SLDRI-4	2 3/8" Entrance, Drive-in Latch bolt for G2 Lockset	
	SLDRI-5	2 3/8" Privacy / Passage, Drive-in Latch bolt for G2 Lockset	
<b>TAIL PIECE</b>			
	ICTP-03	6-pin Tail Piece for IC Explorer Series	----
	ICTP-04	7 Pin Tail Piece for IC Explorer Series	
	ICTP-05	6-pin Tail Piece for ICXP03 Explorer Series Classroom Function Only	
	ICTP-06	7 Pin Tail Piece for ICXP03 Explorer Series Classroom Function Only	
<b>EXTRA UL LISTED BACKSET</b>			
 UL-HIL234    UL-SHIL234	UL-HIL234	XP Series Dead Latch 2 3/4" 2 1/4" x 1 1/8" Faceplate	US3, 26D, 10B, 10, 26
	UL-SHIL234	XP Series Spring Latch 2 3/4" 2 1/4" x 1" Faceplate	
<b>3 3/4", 5" UL LISTED BACKSET</b>			
	SL5	5" UL listed Extension Link	----
	SLD334	3 3/4" Dead latch, 2 1/4" x 1 1/8" Faceplate	US3, 26D, 10B
	SLS334	3 3/4" Spring Latch, 2 1/4" x 1 1/8" Faceplate	
<b>STRIKES</b>			
	TS	T-Strike	US3, 4, 26D, 26 10B, 10, 15
	FLS	Full lip strike	US3, 4, 26D, 10B, 10, 15, 26, 5

# CHALLENGER Series

## STANDARD DUTY CYLINDRICAL LEVERSETS

### ANSI STANDARD A156.2, GRADE 2

Ⓢ Optional Interchangeable Core for **Best, Falcon and Arrow**

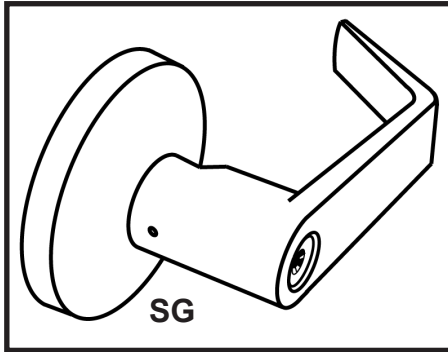

**STOCK ITEM IN BOLD**  
NON-STOCK FINISH AND DESIGNS AVAILABLE WITH FACTORY LEAD TIME  
AND SUBJECT TO MINIMUM ORDER.

FUNCTIONS	ANSI	ITEM #	FINISH				PCS / MC	
Entrance	F109	SG00	<b>US26D</b>	<b>US3</b>	<b>US10B, 26</b>	<b>US15</b>	US10, 4, 15A	10
		Ⓢ ICSG00	US26D					
Entrance Push Button Lock	F82	SG01	<b>US26D</b>	US3	US10B, 26	US15		
		SG05		<b>US3</b>	<b>US10B, 26</b>	<b>US15</b>		
Storeroom	F91	Ⓢ ICSG05	US26D	US3	US10B, 26	US15		
		SG03	<b>US26D</b>	<b>US3</b>	<b>US10B, 26</b>	<b>US15</b>		
Classroom	F84	Ⓢ ICSG03	US26D	US3	US10B, 26	US15		
		SG10			US3	US10B, 26		
Patio	F77	SG10						
Privacy	F76	SG20						
Passage	F75	SG30	<b>US26D</b>	<b>US3</b>	<b>US10B, 26</b>	<b>US15</b>		
Exit	F89	SG50						
Single Dummy	---	SG40						

Ⓢ (IC) Indicates function available with **Best, Falcon and Arrow** Interchangeable Core. For IC Core see pages L105 – L106. For Keying see page L115.



## STANDARD DUTY CYLINDRICAL LEVERSETS ANSI STANDARD A156.2, GRADE 2

**Ⓢ** Optional Interchangeable Core for **Best, Falcon and Arrow**

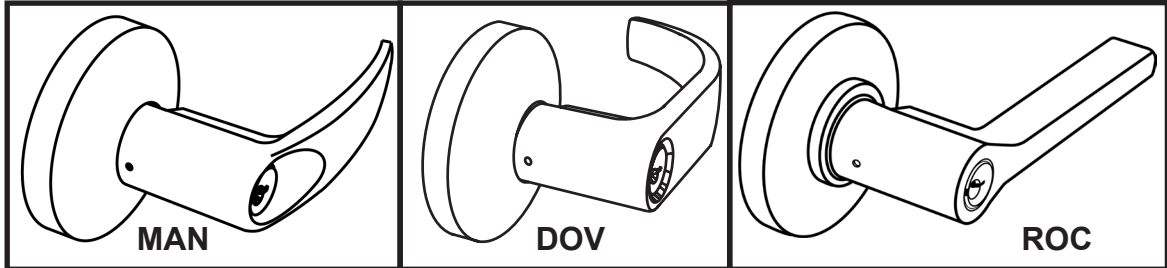

**LIFETIME WARRANTY**



**MEETS**  
*The Buy American Act*

**STOCK ITEM IN BOLD**  
NON-STOCK FINISH AND DESIGNS AVAILABLE WITH FACTORY LEAD TIME  
AND SUBJECT TO MINIMUM ORDER.

FUNCTIONS	ANSI	ITEM #	FINISH	PCS / MC		
Entrance	F109	MAN00 / DOV00 / ROC00	US3	US10B, 26, 15, 15A, 4		
		<b>Ⓢ</b> ICMAN00 / ICDOV00 / ICROC00			US26D	
Storeroom	F91	MAN05 / DOV05 / ROC05			US26D	
		<b>Ⓢ</b> ICMAN05 / ICDOV05 / ICROC05			US26D	
Classroom	F84	MAN03 / DOV03 / ROC03			US26D	
		<b>Ⓢ</b> ICMAN03 / ICDOV03 / ICROC03			US26D	
Patio	F77	MAN10 / DOV10 / ROC10			US26D	10
Privacy	F76	MAN20 / DOV20 / ROC20				
Passage	F75	MAN30 / DOV30 / ROC30			US26D	20
Exit	F89	MAN50 / DOV50 / ROC50	US26D			
Single Dummy	---	MAN40 / DOV40 / ROC40	US26D			

**Ⓢ** (IC) Indicates function available with **Best, Falcon and Arrow** Interchangeable Core. For IC Core see pages L105 – L106. For Keying see page L115.

**STANDARD DUTY CYLINDRICAL LEVERSETS**  
**ANSI STANDARD A156.2, GRADE 2**

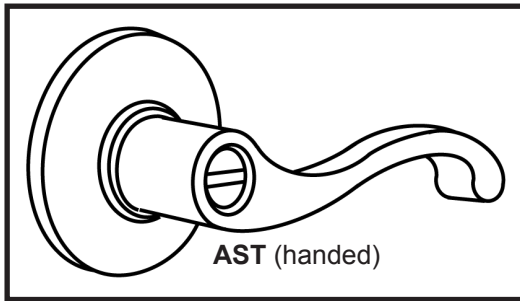

 <small>3 HOUR FIRE RATED UL10C, UBC7-2-1997</small>	<b>LIFETIME WARRANTY</b>	<b>BHMA</b> <b>CERTIFIED</b> <small>Be Safe. Be Secure. Look for the Mark.</small>	<b>MEETS</b> <i>The Buy American Act</i>
--	--------------------------	--	---

**STOCK ITEM IN BOLD**  
**NON-STOCK FINISH AND DESIGNS AVAILABLE WITH FACTORY LEAD TIME AND SUBJECT TO MINIMUM ORDER.**

FUNCTIONS	ANSI	ITEM #	FINISH				PCS / MC
Entrance	F109	AST00	<b>US3</b>	<b>US15, 15A</b>	US26D	US10B, 26	10
Storeroom	F91	AST05					
Classroom	F84	AST03					
Privacy	F75	AST20					
Passage	F75	AST30	US3	US15, 15A			
Exit	F89	AST50	<b>US3</b>	<b>US15, 15A</b>			
Single Dummy	----	AST40	<b>US3</b>	<b>US15, 15A</b>			

\*SH SPECIFY HANDING FOR "AST" Design.

\*HANDING: Entrance, Privacy and Passage functions are reversible non handed on AST designs. Specify handing for convenience. If handing is not available at time of shipment, opposite hand will be shipped. Other functions are handed.

► **PACKAGING INCLUDES**

- UL Listed 2 3/4" backset (2 1/4" x 1", square corner packed with 1/8" filler for 1 1/8" width). 2 3/8" available on request.
- Standard "C", 6-pin cylinder
- All locksets are packed with ASA Strike

8 ► **IC CORES, KEYING**

For IC Core see pages L105 – L106.  
 For Keying see page L115.

► **MOUNT**



2 hole wooden mount

► **KEYWAYS**

6-pin solid brass "C" keyway standard. Optional: Schlage E, Schlage C-K, Russwin D1-2-3-4, Corbin 59 / 60, Arrow A, Corbin-Russwin L4, Sargent LA-LB-LC, Falcon / Weiser E, Yale 8, Yale GA and Kwikset. Can also accept Medeco, Assa, Kaba and **Cal-Royal HSK** High Security Cylinders. See page L115 for keying and Cylinder PART #.

► **ADDITIONAL PARTS FOR CHALLENGER SERIES**

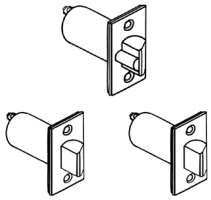
Backsets: UL listed 2 3/8", (2 1/4" x 1") faceplate

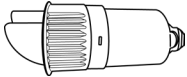
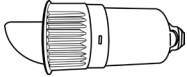
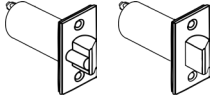
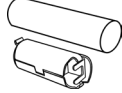
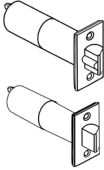
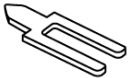
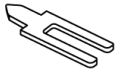
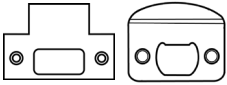
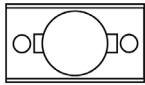
ILLUSTRATION	ITEM #	DESCRIPTION	FINISH
	UL-HIL238	2 3/8" UL-listed Dead latch, 2 1/4" x 1" Faceplate ( key functions only )	US3, 26D, 10B, 10, 26
	ULSLS238	2 3/8" UL-listed Spring Latch, 2 1/4" x 1" Faceplate ( for privacy only )	US3, 26D, 10B, 10, 26
	UL-SHIL238	2 3/8" UL-listed Spring Latch, 2 1/4" x 1" Faceplate ( for passage only )	US3, 26D, 10B, 10, 26
	ULSGPA238	2 3/8" UL-listed Dead Latch, 2 1/4" x 1" Faceplate ( for SG10, SL10 Patio Function and SL101 Dormitory/ Assisted Living Function )	US26D
	SLDRI-1	2 3/4" Entrance, Drive-in Latch bolt for G2 Lockset	ZINC
	SLDRI-4	2 3/8" Entrance, Drive-in Latch bolt for G2 Lockset	ZINC
	SLDRI-2	2 3/4" Privacy / Passage, Drive-in Latch bolt for G2 Lockset	ZINC
	SLDRI-5	2 3/8" Privacy / Passage, Drive-in Latch bolt for G2 Lockset	ZINC
<b>EXTRA UL LISTED BACKSET</b>			
	UL-HIL234	Dead Latch 2 3/4" 2 1/4" x 1 1/8" Faceplate	US3, 26D, 10B, 10, 26
	UL-SHIL234	Spring Latch 2 3/4" 2 1/4" x 1" Faceplate	US3, 26D, 10B, 10, 26
<b>3 3/4", 5" UL LISTED BACKSET</b>			
	SL5	5" UL listed Extension Link	----
	SLD334	3 3/4" Dead latch, 2 1/4" x 1 1/8" Faceplate	US3, 26D, 10B
	SLS334	3 3/4" Spring Latch, 2 1/4" x 1 1/8" Faceplate	US3, 26D, 10B
<b>TAIL PIECE</b>			
	ICTP-03	6-pin Tail Piece for IC Challenger Series	----
	ICTP-04	7-Pin Tail Piece for IC Challenger Series	
<b>STRIKES</b>			
	TS	T strike	US3, 26D, 10B, 10, 15, 26, 4
	FLS	Full lip strike	US3, 26D, 10B, 10, 15, 26, 4, 15A
	LFA18	Latch front adapter to convert 1" faceplate to 1 1/8" wide door preparation	CLEAR

## BARRINGTON BA Series

### STANDARD DUTY CYLINDRICAL LOCKSETS

### ANSI A156.2 Series 4000 Grade 2

● Optional Interchangeable Core for **Best, Falcon and Arrow**

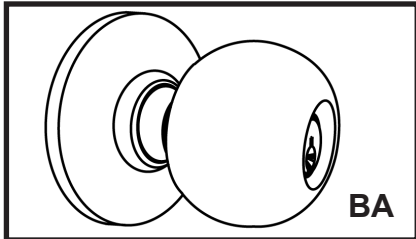

**LIFETIME WARRANTY**

**MEETS**  
*The Buy American Act*

**STOCK ITEM IN BOLD**

NON-STOCK FINISH AND DESIGNS AVAILABLE WITH FACTORY LEAD TIME AND SUBJECT TO MINIMUM ORDER.

Made in Korea									
FUNCTION	ANSI	ITEM #	FINISH				PCS / MC		
Entrance *****KA/4	F109	BA00	US32D	US10B	US3	US10	US4, 26	20	
		● ICBA00				US10			
Combination Entrance and Single Cylinder Deadbolt -- KA / 2 packed together	<b>NEW ITEM</b>	BA00 / T220		US10B	US3	US10			
		Classroom		F84	BA03	US10B			US3
Storeroom	F86	BA05		US10B	US3	US10			US10
		● ICBA05		US10B		US10			
Communicating Institution	F80	BA04		US10B	US3	US10			
Privacy	F87	BA09				US10			
Passage	F76	BA20				US10			
Exit	F75	BA30				US10			
Single Dummy	F89	BA50			US10	50			
	----	BA40			US10				
Made in Taiwan									
FUNCTION	ANSI	ITEM #	FINISH				PCS / MC		
Entrance *****KA / 4	F109	TBA00	US32D	US10B	US3	US3	US10, US4, 26	20	
		● ICTBA00				US3			
Classroom	F84	TBA03		US10B	US3	US3			
		● ICTBA03		US3					
Storeroom	F86	TBA05		US10B	US3	US3			
		● ICTBA05				US3			
Storelock	F91	TBA02		US10B	US3	US3			
Communicating Institution	F80	TBA04				US3			
Privacy	F87	TBA09		US10B	US3	US3			
Passage	F76	TBA20				US3			
Exit	F75	TBA30	US3						
Single Dummy	F89	TBA50	US32D		US3	50			
	----	TBA40	US32D		US3				

● (IC) Indicates function available with **Best, Falcon and Arrow** Interchangeable Core. For IC Core see pages L105 – L106. For Keying see page L115.

# POLYGON PLG Series

## STANDARD DUTY CYLINDRICAL LOCKSETS

### ANSI A156.2 Series 4000 Grade 2

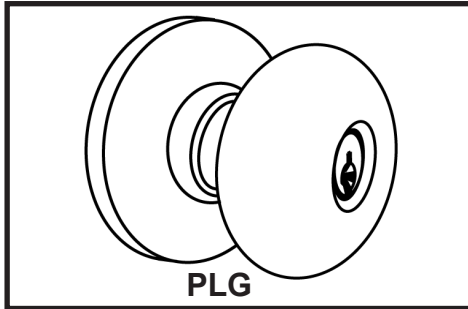

**LIFETIME  
WARRANTY**

**MEETS**  
*The Buy American Act*

**STOCK ITEM IN BOLD**  
NON-STOCK FINISH AND DESIGNS AVAILABLE WITH FACTORY LEAD TIME  
AND SUBJECT TO MINIMUM ORDER.

FUNCTION	ANSI	ITEM #	FINISH			PCS / MC
Entrance *****KA / 4	F109	PLG00	<b>US32D</b>	US3, 10B	US4, 10	20
Classroom	F91	PLG03				
Storeroom	F84	PLG05				
Storelock	F91	PLG02				
Communicating	F80	PLG04				
Institution	F87	PLG09				
Privacy	F76	PLG20				
Passage	F75	PLG30				
Exit	F89	PLG50				
Single Dummy	----	PLG40				50

► **PACKAGING INCLUDES**

- UL Listed 2 3/4" Backset (2 1/4"x 1 1/8" faceplate)
- Standard "C", 6-pin cylinder
- ASA Strike

► **KEYWAYS**

6-pin solid brass "C" keyway standard. Optional: Schlage E, Schlage C-K, Russwin D1-2-3-4, Corbin 59 / 60, Corbin-Russwin L4, Sargent LA-LB-LC, Falcon / Weiser E, Arrow A, Yale 8, Yale GA and Kwikset. Can also accept Medeco, Assa, Kaba and **Cal-Royal HSK** High Security Cylinders. See **page L115** for keying and Cylinder PART #.

8 ► **IC CORES, KEYING**







For IC Core see pages L105 – L106.  
For Keying see page L115.

► **TACTILE / LEAD LINING**

- Lead Lining Part # **LEAD**
- Tactile Part # **TAC**

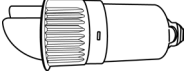
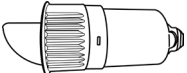
► **ADDITIONAL PARTS FOR BARRINGTON AND POLYGON SERIES**

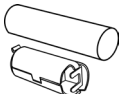
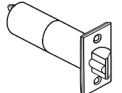
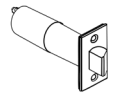
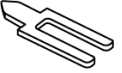
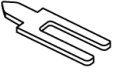
Backsets: UL listed 2 3/8", (2 1/4" x 1") faceplate

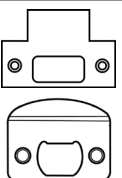
ILLUSTRATION	ITEM #	DESCRIPTION	FINISH
	ULSLD238	BA Series UL-listed Dead Latch 2 3/8" PLG Series UL-listed Dead Latch 2 3/8" 2 1/4" x 1" Faceplate	US3, 32D, 10B
	ULSLS238	BA Series UL-listed Spring Latch 2 3/8" PLG Series UL-listed Spring Latch 2 3/8" 2 1/4" x 1" Faceplate	US3, 32D, 10B
	SLDRI-1	2 3/4" Entrance, Drive-in Latch bolt for G2 Lockset	ZINC
	SLDRI-4	2 3/8" Entrance, Drive-in Latch bolt for G2 Lockset	ZINC
	SLDRI-2	2 3/4" Privacy / Passage, Drive-in Latch bolt for G2 Lockset	ZINC
	SLDRI-5	2 3/8" Privacy / Passage, Drive-in Latch bolt for G2 Lockset	ZINC
<b>EXTRA UL LISTED BACKSET</b>			
	ULSLD234	Dead Latch 2 3/4" 2 1/4" x 1 1/8" Faceplate	US3, 26D, 10B, 10, 26
	ULSLS234	Spring Latch 2 3/4" 2 1/4" x 1 1/8" Faceplate	US3, 26D, 10B, 10, 26
<b>3 3/4", 5" UL LISTED BACKSET</b>			
	SL5	5" UL listed Extension Link	----
	SLD334	BA Series 3 3/4" Dead latch PLG Series 3 3/4" Dead latch 2 1/4" x 1 1/8" Faceplate	US3, 26D, 10B
	SLS334	BA Series 3 3/4" Spring Latch PLG Series 3 3/4" Spring Latch 2 1/4" x 1 1/8" Faceplate	US3, 26D, 10B
<b>TAIL PIECE</b>			
	ICTP-03	6-pin Tail Piece for ICBA Series	----
	ICTP-04	7 Pin Tail Piece for ICBA Series	
	ICTP-08	Tail Piece for ICTBA Only	
<b>STRIKES</b>			
	TS	T-Strike	US3, 26D, 10B, 10, 15, 26, 4
	FLS	Full Lip Strike	

## COLUMBUS Series

### ANSI A156.2 GRADE 3 CYLINDRICAL LOCKSET, ORBIT STYLE

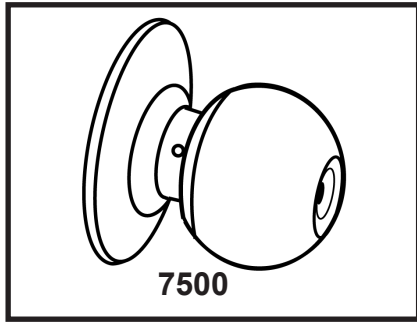

**LIFETIME  
WARRANTY**

**STOCK ITEM IN BOLD**

NON-STOCK FINISH AND DESIGNS AVAILABLE WITH FACTORY LEAD TIME AND SUBJECT TO MINIMUM ORDER.

FUNCTION	ANSI	ITEM #			FINISH	PCS / MC
Entrance KA / 4	F109	7500	<b>US32D</b>	<b>US3,5</b>	<b>US10B</b>	US4, 10, 15, 15A
Classroom	F84	7503			US10B	
Storeroom	F86	7505			<b>US10B</b>	
Privacy	F76	7520			US10B	
Passage	F75	7530				
Single Dummy	----	7540				
						20
						40

► **PACKAGING INCLUDES**

- Adjustable 2 3/8" to 2 3/4" backset square corner. Preset 2 3/8"
- Standard "C", 6-pin cylinder
- T-strike

► **KEYWAYS**

6-pin solid brass "C" keyway standard. Optional: Schlage E, Schlage C-K, Russwin D1-2-3-4, Corbin 59 / 60, Corbin-Russwin L4, Sargent LA-LB-LC, Falcon / Weiser E, Arrow A, Yale 8, Yale GA and Kwikset.  
Can also accept Medeco, Assa, Kaba and **Cal-Royal HSK** High Security Cylinders. See page L115 for keying and Cylinder PART #.

► **ADDITIONAL PARTS**

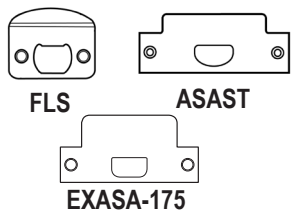
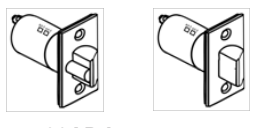
ILLUSTRATION	ITEM #	DESCRIPTION	FINISH
 <p>FLS ASAST EXASA-175</p>	FLS	Full Lip Strike	US3, 26D, 10B, 10, 15, 26, 4, 5, 15A
	ASAST	ASAANSI Strike	US3, 26D, 26
	EXASA-175	Extended Lip ANSI Strike 1 3/4" Lip Extension from Screw Center Line	US10, 10B, 4, 5
 <p>7500ADJ 7520ADJ</p>	7500ADJ	7500 Series Entrance Dead latch Adjustable 2 3/8" or 2 3/4" Backset 2 1/4" x 1" Faceplate	US3, 26D, 10B
	7520ADJ	7500 Series Privacy Spring latch Adjustable 2 3/8" or 2 3/4" Backset 2 1/4" x 1" Faceplate	

## HIL Series

### INTERCONNECTED ENTRANCE LEVER SERIES

### ANSI - A156.12 SERIES 5000, GRADE 2, UL LISTED

**Optional Interchangeable Core for Best, Falcon and Arrow**  
With Interconnecting Mechanism, **Can be used with 4" CTC**

 <small>3 HOUR FIRE RATED UL10C, UBC7-2-1997</small>	<b>LIFETIME WARRANTY</b>	<b>BHMA</b> <sup>TM</sup> <b>CERTIFIED</b> <small>Be Safe. Be Secure. Look for the Mark.</small>	<b>MEETS</b> <i>The Buy American Act</i>
---	--------------------------	--	---

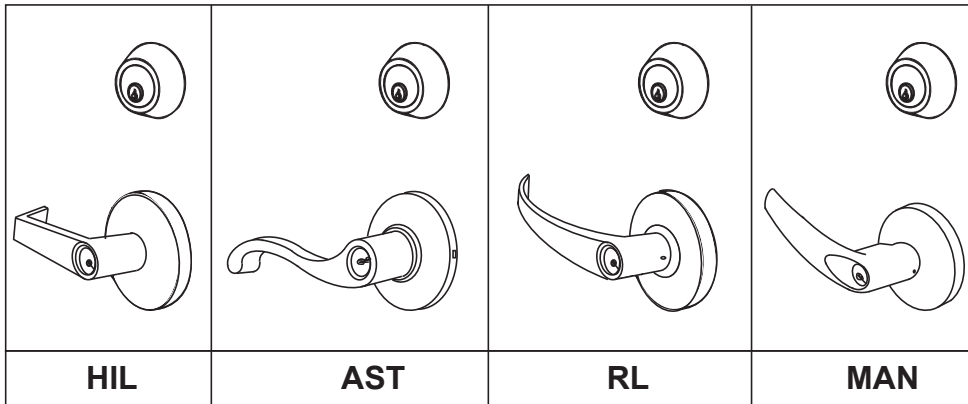

**STOCK ITEM IN BOLD**  
NON-STOCK FINISH AND DESIGNS AVAILABLE WITH FACTORY LEAD TIME  
AND SUBJECT TO MINIMUM ORDER.

FUNCTION	ANSI	ITEM #	FINISH		PCS / MC
Entrance, <b>Double</b> Locking	F109	HIL00	<b>US26D</b>	<b>US3, 15</b>	<b>US10B</b>
		<b>ICHIL00</b>		US3, 15	US10B
Entrance, <b>Single</b> Locking	F75	HIL30	<b>US26D</b>	<b>US3, 15</b>	<b>US10B</b>
		<b>ICHIL30</b>		US3, 15	US10B
Entrance, <b>Double</b> Locking	F109	HILAST00	<b>US26D</b>	<b>US3, 15</b>	<b>US10B</b>
		<b>ICHILAST00</b>		US3, 15	US10B
Entrance, <b>Single</b> Locking	F75	HILAST30	<b>US26D</b>	<b>US3, 15</b>	<b>US10B</b>
		<b>ICHILAST30</b>		US3, 15	US10B
Entrance, <b>Double</b> Locking	F109	HILRL00	<b>US26D</b>	<b>US3, 15</b>	<b>US10B</b>
		<b>ICHILRL00</b>		US3, 15	US10B
Entrance, <b>Single</b> Locking	F75	HILRL30	<b>US26D</b>	<b>US3, 15</b>	<b>US10B</b>
		<b>ICHILRL30</b>		US3, 15	US10B
Entrance, <b>Double</b> Locking	F109	HILMAN00	<b>US26D</b>	<b>US3, 15</b>	<b>US10B</b>
		<b>ICHILMAN00</b>		US3, 15	US10B
Entrance, <b>Single</b> Locking	F75	HILMAN30	<b>US26D</b>	<b>US3, 15</b>	<b>US10B</b>
		<b>ICHILMAN30</b>		US3, 15	US10B

\* Specify handing when ordering AST design

- Indicates deadbolt available with Interchangeable Core. Cores are compatible 6 or 7 pin with **Best, Falcon and Arrow**. For IC Core see pages L105 – L106. For Keying see page L115.
- Indicates deadbolt and entrance lever available with Interchangeable Core. Cores are compatible 6 or 7 pin with **Best, Falcon and Arrow**. For IC Core see pages L105 – L106. For Keying see page L115.



## JHIL Series

### INTERCONNECTED ENTRANCE LEVER SERIES ANSI - A156.12 SERIES 5000, GRADE 2, UL LISTED

- Optional Interchangeable Core for Best, Falcon and Arrow
- Optional Large Format Interchangeable Core for Schlage  
With Interconnecting Mechanism, Can be used with 4" or 5 1/2" CTC

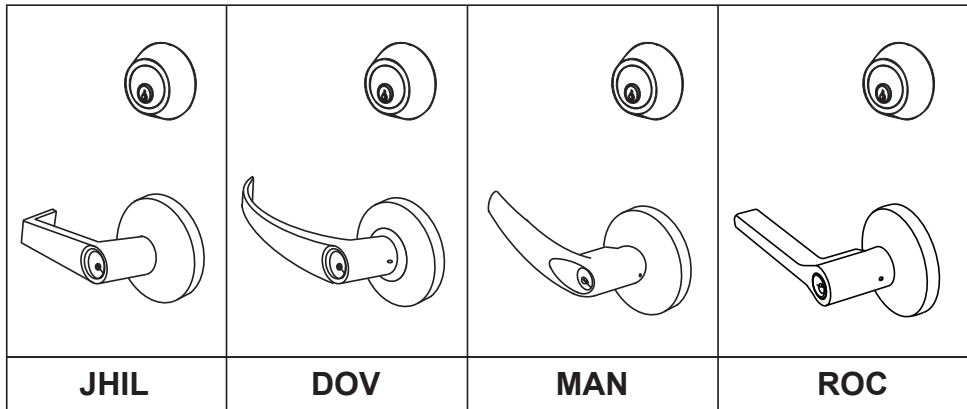

**MEETS**  
*The Buy American Act*

**STOCK ITEM IN BOLD**  
NON-STOCK FINISH AND DESIGNS AVAILABLE WITH FACTORY LEAD TIME AND SUBJECT TO MINIMUM ORDER.

FUNCTION	ANSI	ITEM #	FINISH			PCS / MC
Entrance, <b>Double</b> Locking	F109	JHIL00	<b>US26D</b>	US3	US15	US10B
		•• ICJHIL00	US26D			
Entrance, <b>Single</b> Locking	F75	JHIL30	<b>US26D</b>	US3	US15	US10B
		• ICJHIL30				
		• ICSCJHIL30				
Entrance, <b>Double</b> Locking	F109	JHILROC00	US26D	US3	US15	US10B
		•• ICJHILROC00				
Entrance, <b>Single</b> Locking	F75	JHILROC30	<b>US26D</b>	US3	US15	US10B
		• ICJHILROC30				
		• ICSCJHILROC30				
Entrance, <b>Double</b> Locking	F109	JHILDOV00	US26D	US3	US15	US10B
		•• ICJHILDOV00				
Entrance, <b>Single</b> Locking	F75	JHILDOV30	<b>US26D</b>	US3	US15	US10B
		• ICJHILDOV30				
		• ICSCJHILDOV30				
Entrance, <b>Double</b> Locking	F109	JHILMAN00	US26D	US3	US15	US10B
		•• ICJHILMAN00				
Entrance, <b>Single</b> Locking	F75	JHILMAN30	<b>US26D</b>	US3	US15	US10B
		• ICJHILMAN30				
		• ICSCJHILMAN30				

- (IC) Indicates deadbolt available with Interchangeable Core. Cores are compatible 6 or 7 pin with **Best, Falcon and Arrow**. For IC Core see page L105. For Keying see page L115
- (ICSC) Indicates deadbolt available with Large Format Interchangeable Core for Schlage. For IC Core see page L106. For Keying see page L115.

► **PACKAGING INCLUDES**

- UL Listed 2 3/4" backset, 2 1/4" x 1 1/8" faceplate for HIL Series
- UL Listed 2 3/4" backset, 2 1/4" x 1" faceplate with 1/8" plastic filler for **JHIL Series**
- Standard "C", 6-pin cylinder
- T-Strike, square strike 2 3/4" X 1 1/8" for deadbolt

► **KEYWAYS**

6-pin solid brass "C" keyway standard. Optional: Schlage E, Schlage C-K, Russwin D1-2-3-4, Corbin 59 / 60, Corbin-Russwin L4, Corbin-Russwin L4, Sargent LA-LB-LC, Falcon / Weiser E, Arrow A, Yale 8, Yale GA and Kwikset. Can also accept Medeco, Assa, Kaba and **Cal-Royal HSK** High Security Cylinders. See **page L115** for keying and Cylinder PART #.

► **IC CORES, KEYING**

For IC Core see pages **L105 – L106**. For Keying see page **L115**.

► **ADDITIONAL PARTS FOR HIL AND JHIL SERIES**

**Backset:** UL Listed 2 3/8" with 2 1/4" x 1 1/8" Faceplate

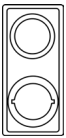
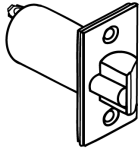
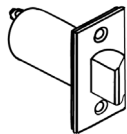
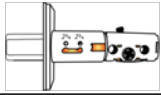
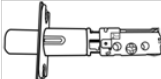
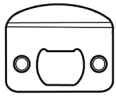
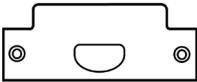
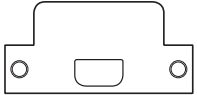
ILLUSTRATION	ITEM #	DESCRIPTION	FINISH
	HILESC1	Escutcheon Plate for Exterior Trim for HIL and JHIL Series (JHIL used with 4" CTC Only)	US3, 26D, 15, 10B
	UL-HIL238	<b>For HIL &amp; JHIL:</b> Dead Latch 2 3/8" for lever lock, 2 1/4" x 1" faceplate (for entry only)	US3, 26D, 10B
	UL-HIL234	<b>For HIL:</b> Dead Latch 2 3/4" for lever lock 2 1/4" x 1 1/8" faceplate (for entry only)	
	ULJHIL234	<b>For JHIL:</b> Dead Latch 2 3/4" for lever lock 2 1/4" x 1" faceplate (for entry only)	
	UL-SHIL238	<b>FOR HIL &amp; JHIL:</b> 2 3/8" UL-listed Spring Latch, 2 1/4" x 1" faceplate (for passage only)	
	UL-SHIL234	<b>For HIL:</b> 2 3/4" UL-listed Spring Latch 2 1/4" x 1 1/8" faceplate (for passage only)	
	ULSJHIL234	<b>For JHIL:</b> 2 3/4" UL-listed Spring Latch 2 1/4" x 1" faceplate (for passage only)	
	ULJHILADJ	Adjustable Deadbolt Latch 2 3/8" or 2 3/4" for JHIL	US3, 26D, 10B
	T220ADJ	Adjustable Deadbolt Latch 2 3/8" or 2 3/4" for HIL	
<b>STRIKES</b>			
	FLS	Full Lip Strike	US3, 26D, 10B, 15, 4, 5, 26
	ASAST	ASA Strike	US3, 26D US10B
	EXASA-175	Extended Lip ANSI Strike 1 3/4" Lip Extension from Screw Center Line	US32D, DURO

## EPIC Series

### LIGHT DUTY CYLINDRICAL LEVERSETS

### MEETS ANSI STANDARD A156.2, GRADE 3

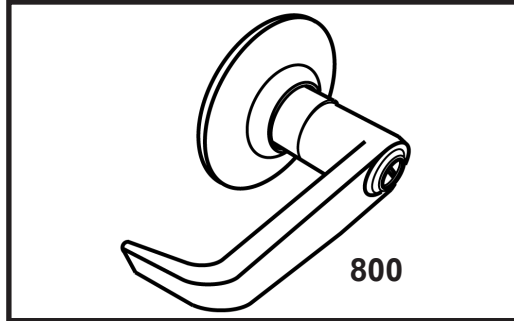

**STOCK ITEM**  
**IN BOLD**  
NON-STOCK FINISH AND DESIGNS  
AVAILABLE WITH FACTORY LEAD TIME  
AND SUBJECT TO MINIMUM ORDER.

#### COMMERCIAL PACKAGING

**ENTRANCE leversets, Schlage "C" 5 pin keyway, KD packed with ASA Strike, 2 3/4" backset (1 1/8" x 2 1/4" square corner).**

ITEM #	ANSI	FUNCTION	FINISH	PCS / MC
800	F109	Entrance Cylindrical Lock with 4 7/8" ASA Commercial Strike, 5 pin Schlage "C" cylinder, KD	US26D, 3	24
800			US4	
800			US10B	
<b>ENTRANCE leversets, Schlage "C" 5 pin keyway, KD packed with ASA Strike, 2 3/4" backset (1 1/8" x 2 1/4" square corner).</b>				
*802	F76	Privacy	US26D	24
803	F75	Passage	US26D	
*802	F76	Privacy	US10B	
803	F75	Passage	US10B	
*802	F76	Privacy	US4	
*802	F76	Bathroom (split finish)	US4 / US26D	
803	F75	Passage	US4	
805	----	Dummy	US26D, 3, 5, 26, 10B, 4	36

#### RESIDENTIAL PACKAGING

**PRIVACY AND PASSAGE leversets packed with Full Lip Strike round corner, 2 3/8" backset (1" x 2 1/4" round corner).**

ITEM #	ANSI	FUNCTION	FINISH	PCS / MC
*RES802	F76	Privacy	US26D	24
RES803	F75	Passage	US26D	
*802	F76	Privacy	US3, 26	
803	F75	Passage	US3, 26	
*802	F76	Privacy	US5	
803	F75	Passage	US5	
805	----	Dummy	US26D, 3, 5, 26, 10B, 4	36

\*Turning inside lever or closing door releases button

\*\*Other strikes and backsets available upon request subject to minimum quantity and lead time.

► **KEYWAYS**

5-pin solid brass "C" keyway standard.

► **ADDITIONAL PARTS FOR EPIC SERIES**

Backset: 2 3/8" with 2 1/4" x 1 1/8" Faceplate

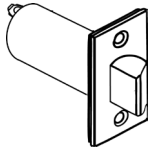
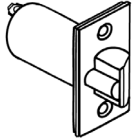
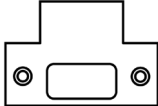
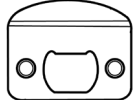
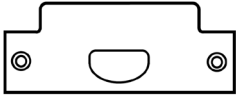
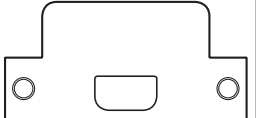
ILLUSTRATION	ITEM #	DESCRIPTION	FINISH
	8PAS238	Round Corner 2 3/8" Passage Spring Latch	US3, 26D, 10B
	8PRI238	Round Corner 2 3/8" Privacy Spring Latch	US3, 26D, 10B
	ULSLS234	Round Corner 2 3/4" Spring Latch	US3, 26D, 10B
	ULSLD234	Square Corner 2 3/4" x 1 1/8" Dead latch	US3, 26D, 10B
	EPD238 / ULSLD238	Square Corner 2 3/8" x 1" Dead latch	US3, 26D, 10B
<b>STRIKES</b>			
	TS	T-Strike	US3, 26D, 10B, 26, 4
	FLS	Full Lip Strike	
	ASAST	ASA Strike	US3, 26D, 26
			US10B, 4
	EXASA-175	Extended Lip ANSI Strike 1 3/4" Lip Extension from Screw Center Line	US32D, DURO

**KEYING**

ITEM #	DESCRIPTION
KARES	Key alike
MKRES	Master key (Including KA)
CMKRES	Builder construction master key (Including KA & MK)
GMKRES	Grand master key (Including KA, MK)

## CRB800 Series

### HEAVY DUTY DEADBOLTS, ANSI STANDARD- A156.5, GRADE 1

- Optional Interchangeable Core for **Best, Falcon and Arrow**
- Optional Interchangeable Core for **Schlage Full Size** format

 <small>3 HOUR FIRE RATED UL10C, UBC7-2-1997</small>	<b>LIFETIME WARRANTY</b>	<b>BHMA™</b> <b>CERTIFIED</b> <small>Be Safe. Be Secure. Look for the Mark.</small>	<b>MEETS</b> <i>The Buy American Act</i>
---	--------------------------	---	---

<b>CRB800</b>	<b>CRB700</b>	● <b>ICRB800</b> ● <b>ICSCRB800</b>	● <b>ICRB700</b>	<b>CRB600</b>	● <b>ICRB600</b> ● <b>ICSCRB600</b>

**STOCK ITEM IN BOLD**  
NON-STOCK FINISH AND DESIGNS AVAILABLE WITH FACTORY LEAD TIME AND SUBJECT TO MINIMUM ORDER.

FUNCTION	ANSI	ITEM #	FINISH			PCS / MC
Grade 1, UL Listed <b>Single Cylinder Deadbolt,</b> "C" Keyway	E0152 <b>NEW ITEM</b>	CRB800	<b>US26D</b>	US3, 15	US10B	US4, 5, 26
		● <b>ICRB800</b>				US4, 5, 26
Grade 1, UL Listed <b>Double Cylinder Deadbolt,</b> "C" Keyway	E0142	CRB700		US3, 15	US10B	US4, 5, 26
		● <b>ICRB700</b>				
<b>Classroom</b> Deadbolt lock, Deadbolt thrown or retracted by key outside. Inside turn unit will retract bolt only. Bolt automatically deadlocks when fully thrown	F109 <b>NEW ITEM</b>	CRB600		US3, 15	US10B	US4, 5, 26
		● <b>ICRB600</b>				
		● <b>ICSCRB600</b>				

- **(IC)** Indicates deadbolt available with Interchangeable Core. Cores are compatible 6 or 7 pin with **Best, Falcon and Arrow**.
- **(ICSC)** Indicates deadbolt available with Large Format Interchangeable Core for Schlage. For IC Core see pages L105 – L106. For Keying see page L115.

▶ **PACKAGING INCLUDES**

- Standard "C" 6-pin cylinder
- Standard UL Listed 2 3/4" backset, optional 2 3/8" backset available. Please specify.
- Latch: Backset latch size 1 1/8" x 2 1/4" faceplate.
- Strike: 1 1/8" x 2 3/4", packed with 3" screws with wood frame reinforcer.

▶ **KEYWAYS**

6-pin solid brass "C" keyway standard. Optional: Schlage E, Schlage C-K, Russwin D1-2-3-4, Corbin 59 / 60, Corbin-Russwin L4, Corbin-Russwin L4, Sargent LA-LB-LC, Falcon / Weiser E, Arrow A, Yale 8, Yale GA and Kwikset. Can also accept Medeco, Assa, Kaba and **Cal-Royal HSK** High Security Cylinders. See **page L115** for keying and Cylinder PART #.

▶ **ANTI MICROBIAL COATING**

Available on US26D and US32D FINISH. Prefix "ANTB" before Part #.

▶ **IC CORES, KEYING**

For IC Core see pages L105 – L106. For Keying see page L115.

▶ **ADDITIONAL PARTS FOR CRB SERIES**

Backsets: 2 3/8"

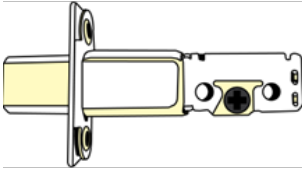
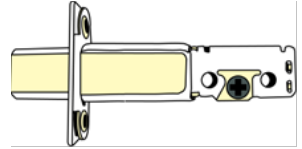
ILLUSTRATION	ITEM #	DESCRIPTION	FINISH
	B800-238	2 3/8" backset (2 1/4" x 1") faceplate	US3, 26D, 10B
	B800-234	2 3/4" backset (2 1/4" x 1 1/8") faceplate	US3, 26D, 10B

## T300 Series

### COMMERCIAL / RESIDENTIAL HEAVY DUTY DEADBOLTS

#### ANSI STANDARD A 156.5, GRADE 2

● **Optional Interchangeable Core for Best, Falcon and Arrow**  
Optional Conversion Kit for up to 2 1/4" Thick Doors

 3 HOUR FIRE RATED UL10C, UBC7-2-1997	<b>LIFETIME WARRANTY</b>	<b>MEETS</b> <i>The Buy American Act</i>	HURRICANE APPROVED HARDWARE FLORIDA BUILDING CODE: FL13922-R1 ASTM E1886/E1996 ASTM E330 TAS 201, 202, 203 UL10B UL10C
---	--------------------------	---	---

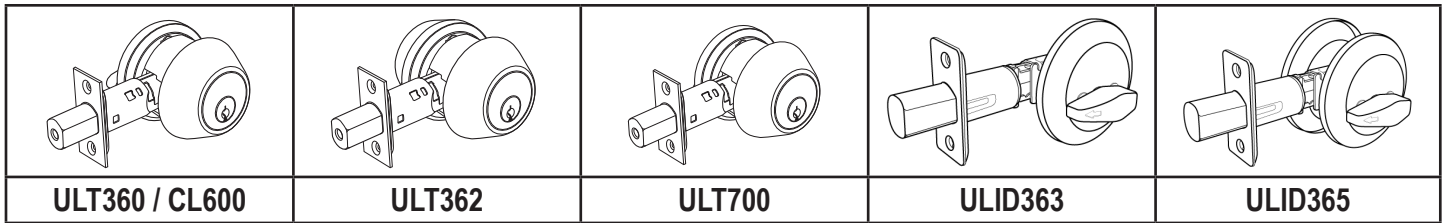

**STOCK ITEM IN BOLD**

NON-STOCK FINISH AND DESIGNS AVAILABLE WITH FACTORY LEAD TIME AND SUBJECT TO MINIMUM ORDER

FUNCTION	ANSI	ITEM #	FINISH							PCS / MC
Heavy Duty <b>Single</b> Cylinder Deadbolt, UL Listed	E0152	ULT360	US3	US10B	US4	US15	US26, US10	US1	US5	20
Heavy Duty <b>Single</b> Cylinder Deadbolt, UL Listed	E0152	●ICULT360								
Heavy Duty <b>Double</b> Cylinder Deadbolt, UL Listed	E0142	ULT362								
Heavy Duty <b>Double</b> Cylinder Deadbolt, UL Listed	E0142	●ICULT362								
<b>Classroom</b> deadbolt lock. UL Listed. Deadbolt thrown or retracted by key outside. Inside turn unit will retract bolt only. Bolt automatically deadlocks when fully thrown. <b>Fixed 2 3/4" backset latchbolt</b> <b>2 3/4" Backset available upon request Part # ULJHILADJ</b>	E0172	CL600	US26D	US10B	US4	US15	US26, US10	US1	US5	20
		●ICCL600								
UL Listed <b>One Sided Latch Bolt</b> retracted by thumb turn, <b>no outside trim</b> . Visible from one side of door only.	----	ULID363	US3	US10B	US4	US15	US26, US10	US1	US5	20
UL Listed <b>One Sided Latch Bolt</b> retracted by thumb turn unit. <b>Blank plate</b> on external trim to be used on bore holes 1 5/8" and 2 1/8" diameter.	----	ULID365								
UL Listed <b>One-Way Deadbolt Lock</b> Deadbolt thrown or retracted by key outside. Blank plate on internal trim to be used on bore holes 1 5/8" and 2 1/8" diameter. Bolt automatically deadlocks when fully thrown. (Exposed Screws)	E1161	ULT700	US3	US10B	US4	US15	US26, US10	US1	US5	20
		●ICULT700								

● (IC) Indicates functions available with Interchangeable Core. Cores are compatible 6 or 7 pin with **Best, Falcon and Arrow**. For IC Core see pages L105 – L106. For Keying see page L115.

► **PACKAGING INCLUDES**

- Standard "C" 6-pin cylinder
- Standard : Adjustable UL Listed 3 Hour Fire Rating 2 3/8" or 2 3/4" latchbolt.
- Latch: Backset latch size 1" x 2 1/4" faceplate, packed with latch front adapter to convert 1" face plate for 1 1/8" wide door preparations
- Strike: 1 1/8" x 2 3/4", packed with 3" screws with wood frame reinforcer.

► **KEYWAYS**



6-pin solid brass "C" keyway standard. Optional: Schlage E, Schlage C-K, Russwin D1-2-3-4, Arrow A, Corbin 59 / 60, Corbin-Russwin L4, Sargent LA-LB-LC, Falcon / Weiser E, Yale 8, Yale GA and Kwikset. Can also accept Medeco, Assa, Kaba and **Cal-Royal HSK** High Security Cylinders. See **page L115** for keying and Cylinder PART #.

► **IC CORES, KEYING**

For IC Core see pages **L105 – L106**. For Keying see page **L115**.

► **ADDITIONAL PARTS FOR T300 SERIES**

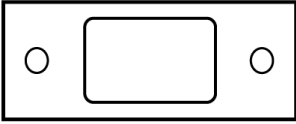
**Backsets:** 2 3/8"

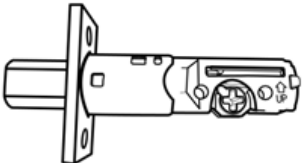
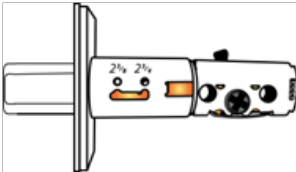
ILLUSTRATION	ITEM #	DESCRIPTION	FINISH
	T2STRK	Deadbolt strike 1 1/8" X 2 3/4"	
	CONVT360	Conversion Kit for 2 1/4" thick doors with tail piece and screws for ULT360 Single Cylinder Deadbolt	
	CONVT362	Conversion Kit for 2 1/4" thick doors with tail piece and screws for ULT362 Double Cylinder Deadbolt	US3, 10B, 26D
	ULT360ADJ	2 3/8" - 2 3/4" Adjustable Latch bolt for ULT360 and ULT362	
	ULJHILADJ	Adjustable Deadbolt Latch 2 3/8" or 2 3/4" for CL600 Classroom Deadbolt	



## T400 Series

### COMMERCIAL / RESIDENTIAL HEAVY DUTY DEADBOLTS

### ANSI STANDARD A 156.5, GRADE 2

OPTIONAL 6-PIN "C" OR 5-PIN KWIKSET KW1 KEYWAY

**LIFETIME  
WARRANTY**

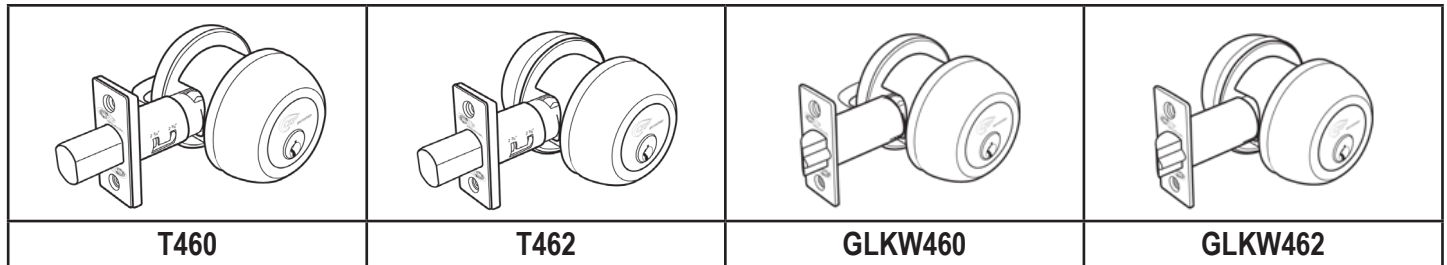

**STOCK ITEM IN BOLD**  
**NON-STOCK FINISH AND DESIGNS AVAILABLE WITH FACTORY LEAD TIME**  
**AND SUBJECT TO MINIMUM ORDER**

DESCRIPTION	ANSI	ITEM #	FINISH		PCS / MC
Single Cylinder Deadbolt, 6-pin "C" Keyway	E0152	<b>T460</b>	US26D, US15, US3	US10B, VB (Venetian Bronze)	US5
Double Cylinder Deadbolt, 6-pin "C" Keyway	E0142	<b>T462</b>			US5
Single Cylinder Deadbolt, 5-pin Kwikset KW1 Keyway	E0152	<b>KWT460</b>			US5
Double Cylinder Deadbolt, 5-pin Kwikset KW1 Keyway	E0142	<b>KWT462</b>			US5
Single Cylinder Deadbolt, 6-pin "C" Keyway	E0152	<b>GL460</b> 2 3/8" Backset	US26D, US15, US3	US10B, VB (Venetian Bronze)	US5
Single Cylinder Gate Latch, 6-pin "C" Keyway	E0152	<b>GL460 / 234</b> 2 3/4" Backset			US5
Double Cylinder Gate Latch, 6-pin "C" Keyway	E0142	<b>GL462</b> 2 3/8" Backset			US5
Double Cylinder Gate Latch, 6-pin "C" Keyway	E0142	<b>GL462 / 234</b> 2 3/4" Backset			US5
Single Cylinder Gate Latch, 5-pin Kwikset KW1 Keyway	E0152	<b>GLKW460</b> 2 3/8" Backset			US5
Single Cylinder Gate Latch, 5-pin Kwikset KW1 Keyway	E0152	<b>GLKW460 / 234</b> 2 3/4" Backset			US5
Double Cylinder Gate Latch, 5-pin Kwikset KW1 Keyway	E0142	<b>GLKW462</b> 2 3/8" Backset			US5
Double Cylinder Gate Latch, 5-pin Kwikset KW1 Keyway	E0142	<b>GLKW462 / 234</b> 2 3/4" Backset			US5

► **PACKAGING INCLUDES**

- Optional Standard "C" 6-pin cylinder or 5-pin Kwikset KW1
- Adjustable 2 3/4" and 2 3/8" backset.
- Latch: Standard 2 1/4" x 1" packed with 1 1/8" plastic filler to convert face plate to 1 1/8" wide door preparations
- Strike: 1 1/8" x 2 3/4", packed with 1 1/2" screws with wood frame reinforcer.

► **KEYWAYS**

Optional 6-pin solid brass "C" or 5 pin Kwikset KW1 keyway standard. Optional: Schlage E, Schlage C-K, Arrow A, Russwin D1-2-3-4, Corbin 59 / 60, Corbin-Russwin L4, Corbin-Russwin L4, Sargent LA-LB-LC, Falcon / Weiser E, Yale 8 and Yale GA. Can also accept Medeco, Assa, Kaba and **Cal-Royal HSK** High Security Cylinders. See **page L115** for keying and Cylinder PART #.

► **KEYING**

Refer to page L115.

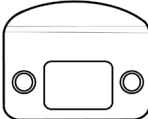
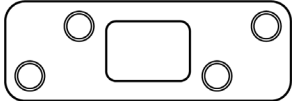
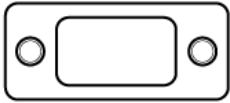
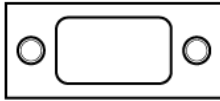
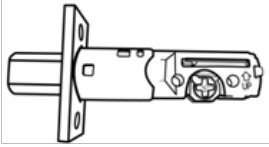
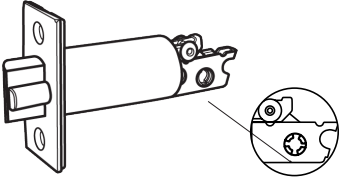
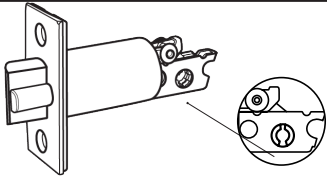

► **ADDITIONAL PARTS FOR T400 SERIES**

ILLUSTRATION	ITEM #	DESCRIPTION	FINISH
	T2STRK	Deadbolt strike 1 1/8" X 2 3/4"	US3, 10B, 26D
	DBFLS	Deadbolt Full Lip Strike, Round Corner	US3, 5, 10B, 15, 15A, 26
	SS114358	Deadbolt Security Strike 1 1/4" x 3 5/8", 1/4" Rad.	US3, 5, 26D
	DBS1214RC	Deadbolt Strike Round Corner 1" X 2 1/4", 1/4" Rad.	
	DBS1214SC	Adjustable Deadbolt Latch 2 3/8" or 2 3/4" for CL600 Classroom Deadbolt	
	T460ADJ	Adjustable 2 3/4" and 2 3/8" Latch Bolt	US3, 10B, 26D
	GL238	2 3/8" backset gate latch and for double cylinder deadbolt	
	GL234	2 3/4" backset gate latch and for double cylinder deadbolt	
	SINGL238	2 3/8" backset gate latch and for single cylinder deadbolt	
	SINGL234	2 3/4" backset gate latch and for single cylinder deadbolt	

# CB160 Series

**STANDARD DUTY DEADBOLTS, ANSI STANDARD - A156.5, GRADE 2  
COMMERCIAL / RESIDENTIAL GR 2 DEADBOLTS / DEAD LATCHES**  
Grade 2 Specifications, Equivalent to Schlage B160 - Series Deadbolts

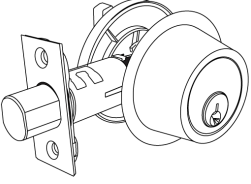
**LIFETIME  
WARRANTY**

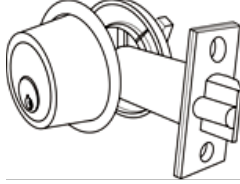
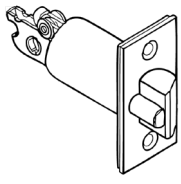
			
<b>CB160</b>	<b>ADP160</b>	<b>GL160</b>	<b>GL238 (2 3/8")</b> <b>GL234 (2 3/4")</b>

**STOCK ITEM IN BOLD**  
NON-STOCK FINISH AND DESIGNS AVAILABLE WITH FACTORY LEAD TIME  
AND SUBJECT TO MINIMUM ORDER

DESCRIPTION	ANSI	ITEM #	FINISH		PCS / MC
Standard Duty <b>Single</b> Cylinder Deadbolt	E0152	CB160	<b>US3, 26D</b>	<b>US10, 10B, 26, 4, 5, 15</b>	36
Standard Duty <b>Double</b> Cylinder Deadbolt	E0142	CB162			
<b>Single</b> Cylinder Gate Latch	E0152	GL160 (2 3/8" backset)			
<b>Double</b> Cylinder Gate Latch	E0142	GL162 (2 3/8" backset)			
<b>Single</b> Cylinder GateLatch	E0152	GL160 / 234 (2 3/4" backset)			
<b>Double</b> Cylinder Gate Latch	E0142	GL162234 (2 3/4" backset)			

► **PACKAGING INCLUDES**

- 2 1/2" Diameter Adapter Ring for 2 1/8" Door Preparations
- Standard "C" 6-pin cylinder
- Adjustable 2 3/4" and 2 3/8" backset
- For gate latches Fixed 2 3/4" and 2 3/8" latch bolt
- Latch: Backset latch size 1" x 2 1/4" faceplate, packed with latch front adapter to convert 1" face plate for 1 1/8" wide door preparations
- Strike: 1 1/8" x 2 3/4"

► **KEYWAYS**



6-pin solid brass "C" keyway standard. Optional: Schlage E, Schlage C-K, Russwin D1-2-3-4, Corbin 59 / 60, Corbin-Russwin L4, Sargent LA-LB-LC, Falcon / Weiser E, Arrow A, Yale 8, Yale GA and Kwikset. Can also accept Medeco, Assa, Kaba and **Cal-Royal HSK** High Security Cylinders. See **page L115** for keying and Cylinder PART #.

► **KEYING**

Refer to page L115.

► **ADDITIONAL PARTS FOR CB160 SERIES**

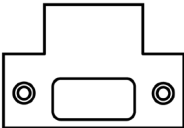
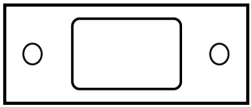
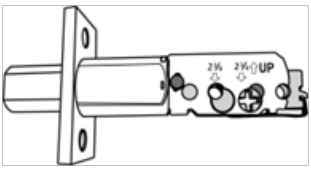
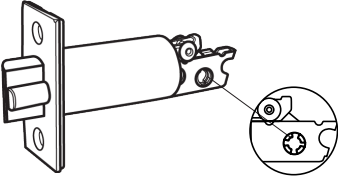
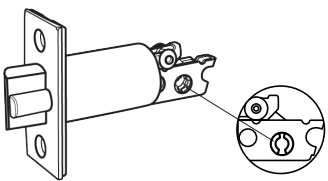
Backsets: 2 3/8".

ILLUSTRATION	ITEM #	DESCRIPTION	FINISH
	TS	T-Strike	US3, 26D, 10B, 26, 10, 4, 15
	T2STRK	Deadbolt Strike 1 1/8" X 2 3/4"	
	CB160ADJ	2 3/8"- 2 3/4" Adjustable Latch bolt for CB160	
	GL238	2 3/8" backset gate latch and for double cylinder deadbolt	US3, 10B, 26D
	GL234	2 3/4" backset gate latch and for double cylinder deadbolt	
	SINGL238	2 3/8" backset gate latch and for single cylinder deadbolt	
	SINGL234	2 3/4" backset gate latch and for single cylinder deadbolt	
	ADP160	Adapter Ring	US10B, 15, 26, 26D, 3, 4, 5

## STANDARD DUTY DEADBOLTS *Series*

### ANSI STANDARD- A156.5, GRADE 3

### COMMERCIAL / RESIDENTIAL DEADBOLTS / DEAD LATCHES

- Optional Interchangeable Core for **Best, Falcon and Arrow**
- Optional Interchangeable Core for **Schlage Full Size** format

**MEETS**  
*The Buy American Act*

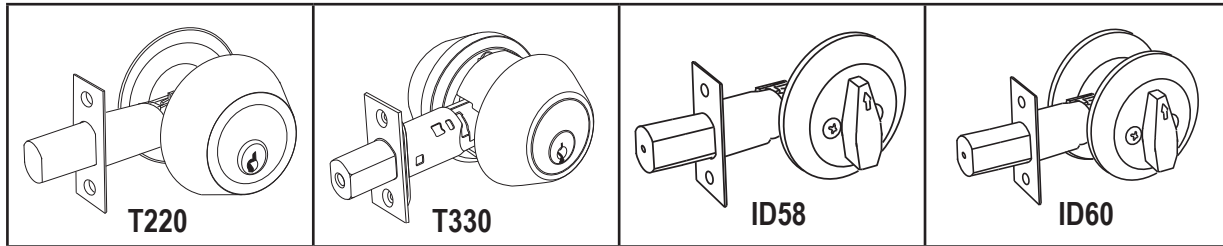

**STOCK ITEM IN BOLD**  
NON-STOCK FINISH AND DESIGNS AVAILABLE WITH FACTORY LEAD TIME AND SUBJECT TO MINIMUM ORDER

DESCRIPTION	ANSI	ITEM #	FINISH								PCS / MC										
			US3, 26D	US10B	US10	US15	US26	US32D	US5	US4		US1									
Standard Duty Single Cylinder Deadbolt	E0153	T220	US3, 26D	US10B	US10	US15	US26	US32D	US5	US4	US1	20									
		ICT220									US1										
Standard Duty Double Cylinder Deadbolt	E0143	T330									US3, 26D		US10B	US10	US15	US26	US32D	US5	US4	US1	20
		ICT330																		US1	

ICT (IC) Indicates functions available with Interchangeable Core. Cores are compatible 6 or 7 pin with **Best, Falcon and Arrow**. For IC Core see page L105. For Keying see page L115.

Standard Duty Single Cylinder Deadbolt With <b>Schlage Big Format IC</b>	E0153	SCICT220	US3, 26D	US10B	US10	US15	US26	US32D	US5	US4	---	20
Standard Duty Double Cylinder Deadbolt With <b>Schlage Big Format IC</b>	E0143	SCICT330					US26					

SCIC (SCIC) Indicates function available with **Schlage full size format Interchangeable Core**. For IC Core see page L106. For Keying see page L115.

Deadbolt thrown or retracted by turn unit only no outside trim. Bore halfway through door for installation visible from one side of door only	---	ID58	US3, 26D	US10B	US10	US15	US26	US32D	US5	US4	---	50
Deadbolt thrown or retracted by turn unit only. Blank plate is on external trim to be used on bore holes 1 3/8" and 2 1/8" wide	---	ID60										

**UPDATED PAGE**  
12-2017

► **ADDITIONAL PARTS FOR STANDARD DUTY DEADBOLTS SERIES**

Backsets: 2 3/8"

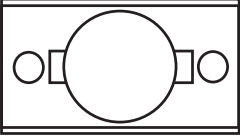
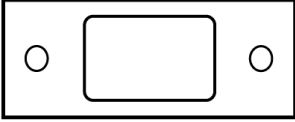
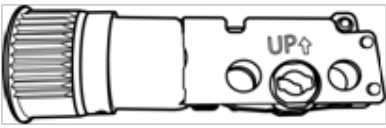
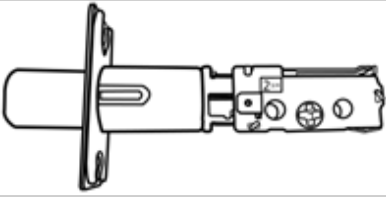
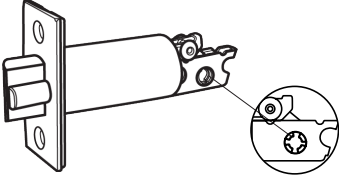
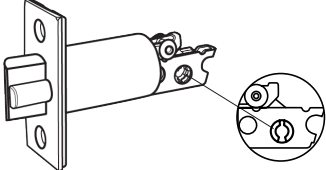
ILLUSTRATION	ITEM #	DESCRIPTION	FINISH
	LFA18	Latch front adapter to convert 1" Plate to 1 1/8" wide door preparations	CLEAR
	T2STRK	Deadbolt strike 1 1/8" x 2 3/4"	US3, 10B, 26D
	T22DRI-6	2 3/8" Drive-in Latch bolt for T220 / T330 Deadbolt	ZINC
	T22DRI-3	2 3/4" Drive-in Latch bolt for T220 / T330 Deadbolt	
	T220ADJ	2 3/8" - 2 3/4" Adjustable Latch bolt for T220 / T330 Deadbolt	US3, 10B, 26D
	GL238	2 3/8" backset gate latch and for double cylinder deadbolt	
	GL234	2 3/4" backset gate latch and for double cylinder deadbolt	
	SINGL238	2 3/8" backset gate latch and for single cylinder deadbolt	
	SINGL234	2 3/4" backset gate latch and for single cylinder deadbolt	

► **PACKAGING INCLUDES**

- Standard "C" 6-pin cylinder.
- Adjustable 2 3/4" and 2 3/8" backset.
- Latch bolt size: 1" x 2 1/4".
- Latch front adapter is supplied in packaging to convert 1" faceplate for 1 1/8" wide door preparations.

► **KEYWAYS**

6-pin solid brass "C" keyway standard. Optional: Schlage E, Schlage C-K, Russwin D1-2-3-4, Corbin 59 / 60, Corbin-Russwin L4, Sargent LA-LB-LC, Falcon / Weiser E, Arrow A, Yale 8, Yale GA and Kwikset. Can also accept Medeco, Assa and Kaba High Security Cylinders. See page L115 for keying and Cylinder PART #.

8 ► **IC CORES, KEYING**

For IC Core see pages L105 – L106. For Keying see page L115.

## GATE LATCH DEAD LATCHES Series

● Optional Interchangeable Core for **Best, Falcon and Arrow**

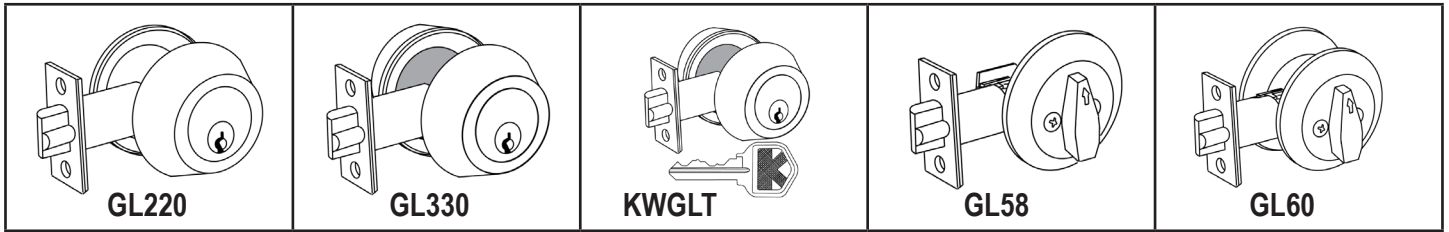

**STOCK ITEM IN BOLD**  
NON-STOCK FINISH AND DESIGNS AVAILABLE WITH FACTORY LEAD TIME AND SUBJECT TO MINIMUM ORDER

DESCRIPTION	ANSI	ITEM #	FINISH							PCS / MC	
<b>Single</b> Cylinder Gate Latch, "C" Keyway	E0153	GL220 ● ICGL220 (2 3/8" backset)	<b>US3</b>	<b>US26D</b>	<b>US10B</b>	<b>US4</b>	<b>US10</b>	<b>US15</b>	<b>US26</b>	<b>US5</b>	20
<b>Single</b> Cylinder Gate Latch, "C" Keyway	E0153	GL220234 ● ICGL220234 (2 3/4" backset)									
<b>Single</b> Cylinder Gate Latch, Kwikset Keyway	E0153	KWGLT220 (2 3/8" backset)									
<b>Single</b> Cylinder Gate Latch, Kwikset Keyway	E0153	KWGLT220234 (2 3/4" backset)									
<b>Double</b> Cylinder Gate Latch, "C" Keyway	E0143	GL330 ● ICGL330 (2 3/8" backset)									
<b>Double</b> Cylinder Gate Latch, "C" Keyway	E0143	GL330234 ● ICGL330234 (2 3/4" backset)									
<b>Double</b> Cylinder Gate Latch, Kwikset Keyway	E0143	KWGLT330 (2 3/8" backset)									
<b>Double</b> Cylinder Gate Latch, Kwikset Keyway	E0143	KWGLT330234 (2 3/4" backset)									

● (IC) Indicates functions available with Interchangeable Core. Cores are compatible 6 or 7 pin with **Best, Falcon and Arrow**. For IC Core see pages L105 – L106. For Keying see page L115.

**STOCK ITEM IN BOLD**

**NON-STOCK FINISH AND DESIGNS AVAILABLE WITH FACTORY LEAD TIME AND SUBJECT TO MINIMUM ORDER**

DESCRIPTION	ITEM #	FINISH								PCS / MC
Gate latch retracted by turn unit only no outside trim. Bore halfway through door for installation visible from one side of door only.	GL58 (2 3/8" backset)	<b>US3</b>	<b>US26D</b>	<b>US4</b>	<b>US10B</b>	<b>US10</b>	<b>US15</b>	<b>US26</b>	US5	50
Gate latch retracted by turn unit only. Blank plate is on external trim to be used on bore holes 1 5/8" x and 2 1/8" wide.	GL60 (2 3/8" backset)									
Gate latch retracted by turn unit only no outside trim. Bore halfway through door for installation visible from one side of door only.	GL58234 (2 3/4" backset)									
Gate latch retracted by turn unit only. Blank plate is on external trim to be used on bore holes 1 5/8" x and 2 1/8" wide.	GL60234 (2 3/4" backset)									

► **PACKAGING INCLUDES**

- Standard "C" 6-pin cylinder or Kwikset KW
- Standard 2 3/8" backset or 2 3/4". Specify backset.
- Latch bolt size: 1 1/8" x 2 1/4"
- Strike size: 1 1/8" x 2 3/4"

► **IC CORES, KEYING**

For IC Core see pages L105 – L106.  
 For Keying see page L115.

► **KEYWAYS**

6-pin solid brass "C" keyway standard.

► **ADDITIONAL PARTS FOR GATE LATCH DEAD LATCHES SERIES**

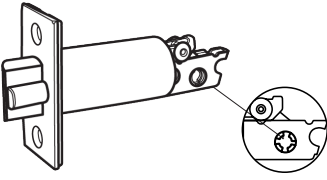
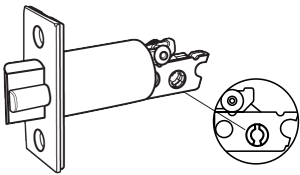
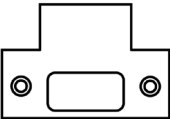
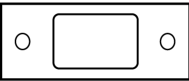
ILLUSTRATION	ITEM #	DESCRIPTION	FINISH
	GL238	2 3/8" backset gate latch and for double cylinder deadbolt	US3, 10B, 26D
	GL234	2 3/4" backset gate latch and for double cylinder deadbolt	
	SINGL238	2 3/8" backset gate latch and for single cylinder deadbolt	
	SINGL234	2 3/4" backset gate latch and for single cylinder deadbolt	
	TS	T-Strike	US3, 26D, 10B, 26, 4, 10, 15
	T2STRK	Deadbolt Strike 1 1/8" X 2 3/4"	US3, 10B, 26D



## LSD Series

### LIGHT COMMERCIAL/RESIDENTIAL STANDARD DUTY DEADBOLTS, ANSI A156.5, GRADE 3

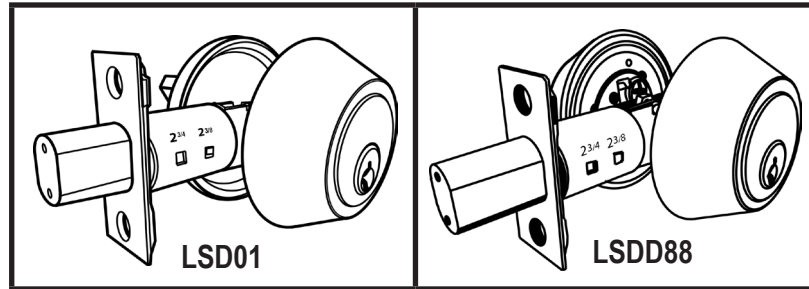

**STOCK ITEM IN BOLD**  
NON-STOCK FINISH AND DESIGNS AVAILABLE WITH FACTORY LEAD TIME  
AND SUBJECT TO MINIMUM ORDER

DESCRIPTION	ANSI	ITEM #	FINISH		PCS / MC	
Standard Duty <b>Single</b> Cylinder Deadbolt	E0153	LSD01	<b>US3, 26D,</b> US32D	<b>US10B,</b> 5, 15	<b>US32</b>	36
Standard Duty <b>Double</b> Cylinder Deadbolt	E0143	LSDD88			US32	36

► **PACKAGING INCLUDES**

- Standard "C" 6-pin cylinder
- Adjustable 2 3/4" and 2 3/8" backset
- Latch: Backset latch size 1" x 2 1/4" faceplate. Latch front adapter is available to convert 1" face plate for 1 1/8" wide door preparations. See below.
- Strike size: 1 1/8" x 2 3/4"

► **KEYWAYS**

6-pin solid brass "C" keyway standard. Optional: Schlage E, Schlage C-K, Russwin D1-2-3-4, Corbin 59 / 60, Corbin-Russwin L4, Sargent LA-LB-LC, Falcon / Weiser E, Arrow A, Yale 8, Yale GA and Kwikset. Can also accept Medeco, Assa, Kaba and **Cal-Royal HSK** High Security Cylinders. See **page L115** for keying and Cylinder PART #.

► **KEYING**

Refer to page L115

► **ADDITIONAL PARTS**

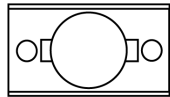
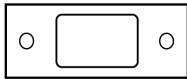
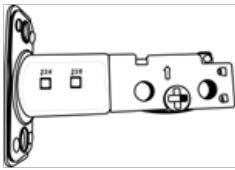
ILLUSTRATION	ITEM #	DESCRIPTION	FINISH
	LFA18	Latch front adapter to convert 1" face plate to 1 1/8" wide door preparations	CLEAR
	T2STRK	Deadbolt strike 1 1/8" X 2 3/4"	US3, 10B, 26D
	ED500ADJ	ED500 Adjustable Latch bolt, round corner 1" X 2 1/4"	US3, 10B, 26D

# IND84 Indicator Deadbolts Series

## COMMERCIAL / RESIDENTIAL INDICATOR DEADBOLTS, ANSI A156.5, GRADE 3

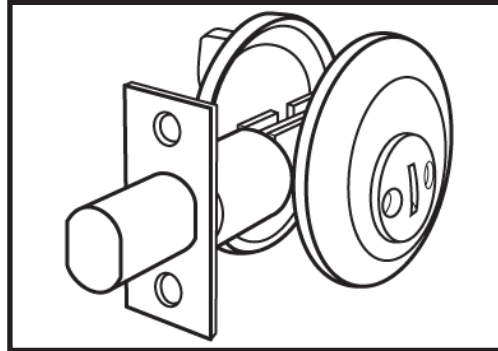

**STOCK ITEM IN BOLD**  
NON-STOCK FINISH AND DESIGNS AVAILABLE WITH FACTORY LEAD TIME  
AND SUBJECT TO MINIMUM ORDER

ITEM #	DESCRIPTION	FINISH		PCS/ MC
IND84	Indicator Deadbolt	<b>US3, 4, 26D</b>	<b>US10B</b>	36

► **PACKAGING INCLUDES**

- Adjustable 2 3/4" and 2 3/8" backset
- Latch: Backset latch size 1" x 2 1/4" faceplate. Latch front adapter is provided to convert 1" face plate for 1 1/8" wide door preparations. See below.
- Strike size: 1 1/8" x 2 3/4"

► **ADDITIONAL PARTS**

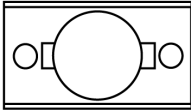
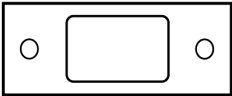
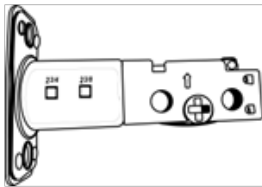
ILLUSTRATION	ITEM #	DESCRIPTION	FINISH
	LFA18	Latch front adapter to convert 1" face plate to 1 1/8" wide door preparations	CLEAR
	T2STRK	Deadbolt strike 1 1/8" X 2 3/4"	US3, 10B, 26D
	ED500ADJ	ED500 Adjustable Latch bolt, round corner 1" X 2 1/4"	US3, 10B, 26D

## ASHLEY Series

### RESIDENTIAL TUBULAR LOCKSETS AND LEVERSETS

#### ANSI STANDARD A156.2, GRADE 3

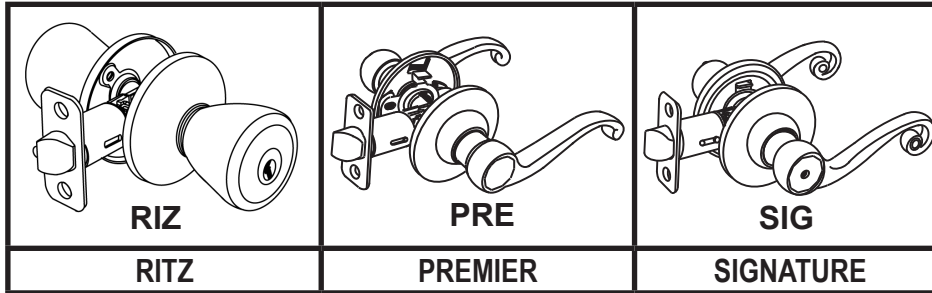

► KEYWAYS KW 5-PIN KWIKSET

**STOCK ITEM IN BOLD**  
NON-STOCK FINISH AND DESIGNS AVAILABLE WITH FACTORY LEAD TIME  
AND SUBJECT TO MINIMUM ORDER

► KNOB DESIGNS

RITZ ----- RIZ SERIES

FUNCTIONS	ANSI	ITEM #	FINISH					PCS / MC	
Entry KA / 3	F109	RIZ00	<b>US3</b>	<b>US26D</b>	<b>US5</b>	<b>US15</b>	US4, 15A, 10B	36	
Storeroom KD	F86	RIZ05		US26D	US5	US15			US26
Privacy	F76	RIZ20		<b>US26D</b>	<b>US5</b>	<b>US15</b>			<b>US26</b>
Bathroom split	F76	RIZ20 / 26	US3	US26D	US5	US15	US26	36	
Passage	F75	RIZ30	<b>US3</b>	<b>US26D</b>	<b>US5</b>	<b>US15</b>	<b>US26</b>		
Dummy	----	RIZ40							

► LEVERSET DESIGNS

PREMIER ----- PRE SERIES

FUNCTIONS	ANSI	ITEM #	FINISH					PCS / MC	
Entry KD Lever / Lever *SH	F109	LEPRE00	<b>US3, 26D</b>	<b>US15</b>	<b>US10B</b>	<b>US26, 15A</b>	US5	US4	24
Privacy *SH	F76	PRE20					<b>US5</b>		
Bathroom split *SH	F76	PRE20 / 26		US15	US10B	US26, 15A	US5		
Passage *SH	F75	PRE30		<b>US15</b>	<b>US10B</b>	<b>US26, 15A</b>	<b>US5</b>		
Dummy *SH	----	PRE40					US5		

\*SH is for specify handing

SIGNATURE ----- SIG SERIES

FUNCTIONS	ANSI	ITEM #	FINISH					PCS / MC	
Entry KD Lever / Lever *SH	F109	LESIG00	<b>US3</b>	US26D	US5	US4, 15A, 15, 10B	US26	24	
Privacy *SH	F76	SIG20					<b>US26</b>		
Bathroom split *SH	F76	SIG20 / 26					US5		US26
Passage *SH	F75	SIG30					<b>US5</b>		<b>US26</b>
Dummy *SH	----	SIG40							

\*SH is for specify handing

Premier and Signature Series are reversible non-handed except **LESIG00**. Specify handing for convenience. If handing is not available at time of shipment opposite hand will be supplied.

► **PACKAGING INCLUDES**

- Adjustable steel 2 3/8" and 2 3/4" backset ( 2 1/4" x 1", 1/4" radius ). Drive in latch bolt also available on request. Square corner available on request on special factory order with lead time and subject to minimum quantity.
- All locksets are packed with full lip strike round corner 1/4" radius.
- Square corner available on request.
- Kwikset rekeyable 5-pin cylinder.

► **ADDITIONAL PARTS FOR ASHLEY SERIES**

ITEM #	DESCRIPTION
DRESADJ	Entrance four way adjustable drive-in latch bolt, square corner
SRESADJ	Privacy, passage four way adjustable drive-in latch bolt, square corner
ASHADJ	Entrance standard adjustable latch bolt, round corner 1" x 2 1/4"
TS	T-Strike
FLS	Full lip strike
ASAST US3, 26D, 26	ANSI ASA strike
ASAST US10B, 10	
EXASA-175 US32D, DURO	Extended Lip ANSI Strike, 1 3/4" Lip Extension from Screw Center Line
K1-KEY	Blank keys K1
KEYS	Extra cut keys
CRT800	Cylinder removal tool
LFA18	Latch front adapter to convert 1" faceplate to 1 1/8" wide door preparation
PDBFLS	Plastic Dust box for Full Lip Strike, 1" x 2 1/8", 7/16" Depth
PDB1214	Plastic Dust box for Residential Deadbolt Strike, 1 5/16" x 2 1/8", 1" Depth
PDB118234	Plastic Dust box for T-Strike, 1 1/16" x 2 3/4", 1" Depth
PDBTS	Plastic Dust box for Deadbolt T2STRK Strike, 1 1/16" x 2 3/4", 1/2" Depth
PDB478	Plastic Dust box for ASA Strike, 1 3/16" x 4 7/8", 15/16" Depth
<b>KEYING KITS</b>	
KKWI200	Keying Kit - KWI Keyway
<b>MOUNT</b>	
RESMOUNT	3 hole mount for residential locks

► **KEYING**

ITEM #	DESCRIPTION
KARES	Key Alike
MKRES	Master Key
CMKRES	Builder Construction Master Key
GMKRES	Grand Master Key ( Including KA, MK & CMK)

## CHELSIE Series

### RESIDENTIAL TUBULAR LOCKSETS, DEADBOLTS, LEVERS AND HANDLESETS, ANSI STANDARD A156.2, GRADE 3

- ▶ **KEYWAYS** ( STD, "KW" 5-PIN KWIKSET ) OPTIONAL 5-PIN SCHLAGE "C" & WEISER
  - All locksets, handle sets and deadbolts are available with **Schlage "C"** and **Weiser** keyway on special factory order only, Consult factory.
  - **SCHLAGE "C" KEYWAY OPTION:** Prefix C before Part # (Ex: REN00 with C keyway is CREN000)
  - **WEISER KEYWAY OPTION:** Prefix "W" before Part # (Ex: REN00 with Weiser keyway is WREN00)

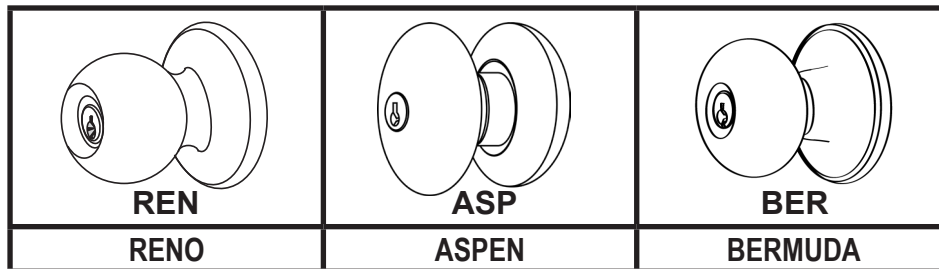

**STOCK ITEM IN BOLD**  
NON-STOCK FINISH AND DESIGNS AVAILABLE WITH FACTORY LEAD TIME AND SUBJECT TO MINIMUM ORDER

#### RENO ----- REN DESIGN

FUNCTIONS	ANSI	ITEM #	FINISH					PCS / MC
Entry - KA / 3	F109	REN-00	<b>US15</b>	<b>US10B</b>	<b>US3, 26D, 32D</b>	<b>US5, US26</b>	<b>US15A</b>	<b>36</b>
Storeroom - KA / 3	F86	REN-05 <sup>NOCK</sup>						
Privacy	F76	REN-20						
Passage	F75	REN-30						
Dummy	----	REN-40						

 Prefix "UL" before Part # when ordering UL Listed, available on Entrance and Passage functions.  
\*\*\*REN05 US26 Non-Stock

#### ASPEN ----- ASP DESIGN

FUNCTIONS	ANSI	ITEM #	FINISH				PCS / MC
Entry - KA / 3	F109	ASP-00	<b>US3</b>	<b>US15</b>	<b>US10B</b>	<b>US5, 15A, 26, 26D</b>	<b>36</b>
Storeroom - KA / 3	F86	ASP-05					
Privacy	F76	ASP-20					
Passage	F75	ASP-30					
Dummy	----	ASP-40					

 Prefix "UL" before Part # when ordering UL Listed, available on Entrance and Passage functions.

#### BERMUDA ----- BER DESIGN

FUNCTIONS	ANSI	ITEM #	FINISH				PCS / MC
Entry - KA / 3	F109	BER-00	<b>US3</b>	<b>US15</b>	<b>US10B</b>	<b>US5, 15A, 26, 26D</b>	<b>36</b>
Storeroom - KA / 3	F86	BER-05					
Privacy	F76	BER-20					
Passage	F75	BER-30					
Dummy	----	BER-40					

 Prefix "UL" before Part # when ordering UL Listed, available on Entrance and Passage functions.

## ► CHELSIE SERIES LEVERSET DESIGNS

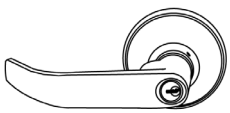
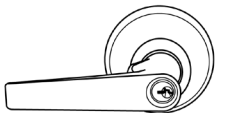
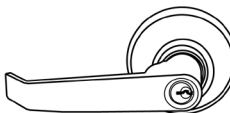
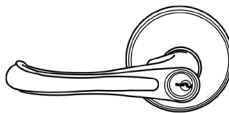
 <b>MAY</b>	 <b>SOP</b>	 <b>LEN</b>	 <b>BRI</b>	 <b>AUS</b>
<b>MAYFAIR</b>	<b>SOPHIA</b>	<b>LENOX</b>	<b>BRISTOL</b>	<b>AUSTIN</b>

### MAYFAIR ----- MAY DESIGN

FUNCTIONS		ANSI	ITEM #	FINISH				PCS / MC
Entry - KA / 3	*SH	F109	MAY-00	US3, 15	US10B	US26D	US5	US15A, 26
Storeroom - KA / 3	*SH	F86	MAY-05					
Privacy	*SH	F76	MAY-20					
Passage	*SH	F75	MAY-30					
Active Dummy	*SH	----	MAY-40					36

 Prefix "UL" before Part # when ordering UL Listed, available on Entrance and Passage functions.  
\* SH is for Specify Handing

### SOPHIA ----- SOP DESIGN

FUNCTIONS		ANSI	ITEM #	FINISH				PCS / MC
Entry - KA / 3		F109	SOP-00	US3, 15	US10B	US26D	US15A, 26	24
Storeroom - KA / 3		F86	SOP-05					
Privacy		F76	SOP-20					
Passage		F75	SOP-30					
Active Dummy		----	SOP-40					36

 Prefix "UL" before Part # when ordering UL Listed, available on Entrance and Passage functions.

### LENOX ----- LEN DESIGN

FUNCTIONS		ANSI	ITEM #	FINISH				PCS / MC
Entry - KA / 3		F109	LEN-00	US3, 15	US10B	US26D	US5, 26	US15A
Storeroom - KA / 3		F86	LEN-05					
Privacy		F76	LEN-20					
Passage		F75	LEN-30					
Active Dummy		----	LEN-40					36

 Prefix "UL" before Part # when ordering UL Listed, available on Entrance and Passage functions.

### BRISTOL ----- BRI DESIGN

FUNCTIONS		ANSI	ITEM #	FINISH				PCS / MC
Entry - KA / 3		F109	BRI-00	US10B	US3, 26D	US15A, 26	24	
Storeroom - KA / 3		F86	BRI-05					
Privacy		F76	BRI-20					
Passage		F75	BRI-30					
Active Dummy		----	BRI-40				36	

 Prefix "UL" before Part # when ordering UL Listed, available on Entrance and Passage functions.

### AUSTIN ----- AUS DESIGN

FUNCTIONS		ANSI	ITEM #	FINISH				PCS / MC
Entry - KA / 3		F109	AUS-00	US3, 15	US10B	US5	US26D	US15A, 26
Storeroom - KA / 3		F86	AUS-05					
Privacy		F76	AUS-20					
Passage		F75	AUS-30					
Active Dummy		----	AUS-40					36





 Prefix "UL" before Part # when ordering UL Listed, available on Entrance and Passage functions.

## ► LEVERSET PACKAGING INCLUDES

- Adjustable steel 2 3/8" and 2 3/4" backset ( 2 1/4" x 1", 1/4" radius ). Drive in latch bolt also available on request. Square corner available on request on special factory order with lead time and subject to minimum quantity.
- All locksets are packed with full lip strike round corner 1/4" radius. Square corner available on request.
- Kwikset rekeyable 5 pin cylinder.

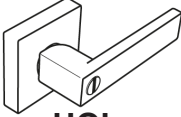
## CONTEMPORARY Series

### RESIDENTIAL LEVERS, ANSI STANDARD A156.2, GRADE 3

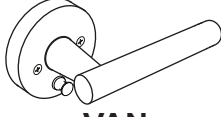
 <b>HOL</b>	 <b>ATL</b>	 <b>JUP</b>	 <b>PHO</b>	 <b>VAN</b>
<b>HOLLAND</b>	<b>ATLAS</b>	<b>JUPITER</b>	<b>PHOENIX</b>	<b>VANITY</b>

**STOCK ITEM IN BOLD**  
NON-STOCK FINISH AND DESIGNS AVAILABLE WITH FACTORY LEAD TIME AND SUBJECT TO MINIMUM ORDER.

#### HOLLAND ----- HOL DESIGN

FUNCTIONS		ANSI	ITEM #	FINISH				PCS / MC
Entry - KD	*NH	F109	HOL-00	<b>US15</b>	<b>US10B</b>	US3, 26D	US5, 15A, 26	20
Privacy	*NH	F76	HOL-20					
Passage	*NH	F75	HOL-30					
Dummy	*NH	----	HOL-40					36

\* NH is for Non-Handed (Reversible) **NOT AVAILABLE WITH UL LATCH** ☒

#### ATLAS ----- ATL DESIGN

FUNCTIONS		ANSI	ITEM #	FINISH				PCS / MC
Privacy	*H	F76	ATL20	<b>US15</b>	<b>US10B</b>	US3, 26D	US5, 15A, 26	20
Passage	*NH	F75	ATL30					
Dummy	*NH	----	ATL40					36

\* NH is for Non-Handed (Reversible) **NOT AVAILABLE WITH UL LATCH** ☒

\* H is for Handed (Order Handling for Convenience)

#### JUPITER ----- JUP DESIGN

FUNCTIONS		ANSI	ITEM #	FINISH				PCS / MC
Entry - KA / 3	*H	F109	JUP-00	<b>US15</b>	<b>US10B</b>	US3, 26D	US5, 15A, 26	20
Privacy	*H	F76	JUP-20					
Passage	*H	F75	JUP-30					
Dummy	*H	----	JUP-40					36

\* H is for Handed (Order Handling for Convenience) **NOT AVAILABLE WITH UL LATCH** ☒

#### PHOENIX ----- PHO DESIGN

FUNCTIONS		ANSI	ITEM #	FINISH				PCS / MC
Entry - KA / 3	*H	F109	PHO-00	<b>US15</b>	<b>US10B</b>	US3, 26D	US5, 15A, 26	20
Privacy	*H	F76	PHO-20					
Passage	*H	F75	PHO-30					
Dummy	*H	----	PHO-40					36

\* H is for Handed (Order Handling for Convenience) **NOT AVAILABLE WITH UL LATCH** ☒

#### VANITY ----- VAN DESIGN

FUNCTIONS		ANSI	ITEM #	FINISH				PCS / MC
Privacy	*H	F76	VAN-20	<b>US15</b>	<b>US10B</b>	US3, 26D	US5, 15A, 26	20
Passage	*NH	F75	VAN-30					
Dummy	*NH	----	VAN-40					36

\* NH is for Non-Handed (Reversible) **NOT AVAILABLE WITH UL LATCH** ☒

\* H is for Handed (Order Handling for Convenience)

**UPDATED PAGE**  
12-2017

## SUMMIT Series

WITH PUSH BUTTON LOCKING MECHANISM

AND AUTO RELEASE FEATURE, ANSI STANDARD A156.2, GRADE 3

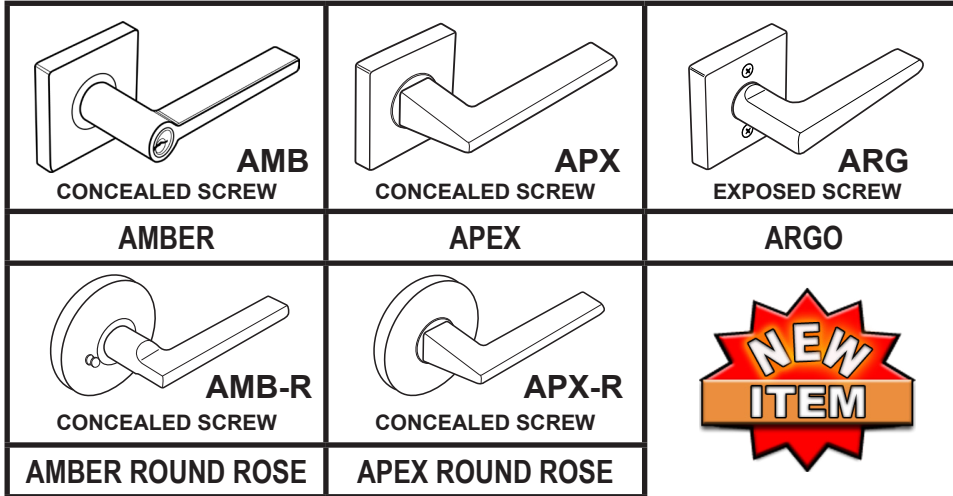

**ALL DESIGNS HAVE  
PUSH BUTTON  
LOCKING MECHANISM  
& AUTO RELEASE  
FOR IMMEDIATE EGRESS,  
PANIC EXIT STRUCTURE  
ON PRIVACY FUNCTIONS.  
KEYED ENTRY FOR  
AMBER DESIGN ONLY.**

**STOCK ITEM IN BOLD**  
NON-STOCK FINISH AND DESIGNS AVAILABLE WITH FACTORY LEAD TIME AND SUBJECT TO MINIMUM ORDER

### AMBER ----- AMB SERIES

FUNCTIONS		ANSI	ITEM #	FINISH					PCS / MC	
Entrance	*NH	---	AMB-00	US15	US26	US26	US10B	US3, 26D	US5, 15A	20
Privacy	*NH	F76	AMB-20							
Passage	*NH	F75	AMB-30							
Dummy	*NH	---	AMB-40							36

Comes standard with Square Rose. Add Suffix "R" after Part # for Round Rose option.

For Example: To order **AMB-20 US15** with Round Rose, use "**AMB-20R US15**" when ordering.

\* NH is for Non-Handed **NOT AVAILABLE WITH UL LATCH** ☒

### APEX ----- APX SERIES

FUNCTIONS		ANSI	ITEM #	FINISH					PCS / MC
Privacy	*NH	F76	APX-20	US15	US26	US10B	US3, 26D	US5, 15A	20
Passage	*NH	F75	APX-30						
Dummy	*NH	---	APX-40						36

Comes standard with Square Rose. Add Suffix "R" after Part # for Round Rose option.

For Example: To order **APX-20 US15** with Round Rose, use "**APX-20R US15**" when ordering.

\* NH is for Non-Handed **NOT AVAILABLE WITH UL LATCH** ☒

### ARGO ----- ARG SERIES





FUNCTIONS		ANSI	ITEM #	FINISH					PCS / MC
Privacy	*NH	F76	ARG-20	US15	US26	US10B	US3, 26D	US5, 15A	20
Passage	*NH	F75	ARG-30						
Dummy	*NH	---	ARG-40						36

Comes standard with Square Rose.

\* NH is for Non-Handed **NOT AVAILABLE WITH UL LATCH** ☒



## ► CHELSIE SERIES HANDLESET DESIGNS

				
<b>MER</b>	<b>SAV</b>	<b>CAM</b>	<b>BAB</b>	<b>DEE</b>
<b>MERIDIAN</b>	<b>SAVANNAH</b>	<b>CAMBRIDGE</b>	<b>BAYBRIDGE</b>	<b>DEERFIELD</b>

**STOCK ITEM IN BOLD**  
NON-STOCK FINISH AND DESIGNS AVAILABLE WITH FACTORY LEAD TIME AND SUBJECT TO MINIMUM ORDER

### MERIDIAN ----- MER DESIGN

FUNCTIONS	ITEM #	FINISH			PCS / MC
Solid Brass Handle with single cylinder deadbolt KD	MER00	PVD US3	US10B	US5,15, 15A, 26	10
Dummy handle set with dummy deadbolt and matching trim	MER40				

\*\*\* All above on the **MER Design** are for any design on knobs and lever sets for interior handle. **PRE Premier Design** is not available for interior handleset. All other trims designs are available. On **Chelsie Series** specify at time of order ( Ex: MER00 / REN )

### SAVANNAH ----- SAV DESIGN

FUNCTIONS	ITEM #	FINISH			PCS / MC
Solid Brass Handle with single cylinder deadbolt KD	SAV00	PVD US3	US10B	US5,15, 15A, 26	10
Dummy handle set with dummy deadbolt and matching trim	SAV40				

\*\*\* All above on the **SAV Series** are for any design on knobs and lever sets for interior handle. **SIG Signature / PRE Premier Designs** are not available for interior handleset. All other trims designs are available. On **Chelsie Series** specify at time of order ( Ex: SAV00 / REN )

### CAMBRIDGE ----- CAM DESIGN

FUNCTIONS	ITEM #	FINISH			PCS / MC
Solid Brass Handle with single cylinder deadbolt KD	CAM00	PVD US3	US10B	US5,15, 15A, 26	10
Dummy handle set with dummy deadbolt and matching trim	CAM40				

\*\*\* All above on the **CAM Design** are for any design on knobs and lever sets for interior handle. **PRE Premier Design** is not available for interior handleset. All other trims designs are available. On **Chelsie Series** specify at time of order ( Ex: CAM00 / REN )

### BAYBRIDGE ----- BAB DESIGN

FUNCTIONS	ITEM #	FINISH			PCS / MC	
Handle w/ single cylinder deadbolt	BAB-00	US15, 15A, 26	US10B	US3, 26D	US5	10
Dummy handle set with dummy deadbolt and matching trim	BAB-40					

\*\*\* All above on the **BAB Design** are for design knob for interior handle. **PRE Premier and SIG Signature Designs** are not available for interior handleset. All other trims designs are available. Specify at time of order ( Ex: BAB00 / LENTRIM is BAB00 with LEN lever design on interior.)

### DEERFIELD ----- DEE DESIGN

FUNCTIONS	ITEM #	FINISH					PCS / MC
Handle with single cylinder deadbolt	DEE-00	US3	US15	US10B	US5, 15A, 26	US26D	10
Dummy handle set with dummy deadbolt and matching trim	DEE-40						

\*\*\* All above on the **DEE Design** are for design knob for interior handle. **PRE Premier and SIG Signature Designs** are not available for interior handleset. All other trims designs are available. Specify at time of order ( Ex: DEE00 / LENTRIM is DEE00 with LEN lever design on interior.)

► **CONTEMPORARY SERIES (ESQ DESIGN), AND CHELSIE SERIES DEADBOLT DESIGNS**  
**ANSI STANDARD A156.5, GRADE 3**

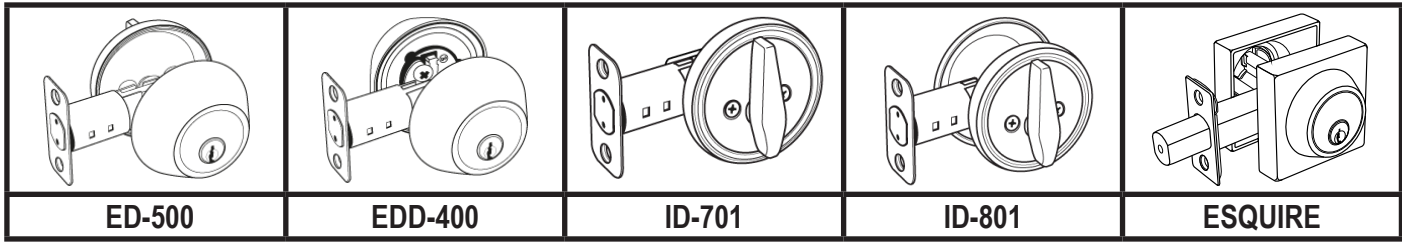

**STOCK ITEM IN BOLD**  
**NON-STOCK FINISH AND DESIGNS AVAILABLE WITH FACTORY LEAD TIME AND SUBJECT TO MINIMUM ORDER**

FUNCTIONS	ITEM #	FINISH								PCS / MC
		US3	US15	US26D	US10B	US15A	US32D	US5	US26	
Single cylinder deadbolt	ED-500	US3	US15	US26D	US10B	US15A	US32D	US5	US26	36
Single cylinder deadbolt 	ULED-500									
Square single cylinder deadbolt	ESQ-101	US3	US15	US26D	US10B	US15A	US32D	US5	US26	
Square double cylinder deadbolt	ESQ-102									
Double cylinder deadbolt	EDD-400	US3	US15	US26D	US10B	US15A	US32D	US5	US26	
One sided deadbolt	ID-701									
One sided deadbolt with exterior cover plate	ID-801									



► **DEADBOLT AND HANDLESET PACKAGING INCLUDES:**

- Adjustable steel 2 3/8" and 2 3/4" backset ( 2 1/4" x 1", 1/4" radius ). Drive in latch bolt also available on request. Square corner available upon request on special factory order with lead time.
- Deadbolts packed with 1" x 2 1/4" strike round corner 1/4" radius and full lip strike 1/4" radius. Square corner available upon request. On special factory order with lead time.

**Security strike** (1 1/4" x 3 5/8", 1/4" radius) with 3" screws available upon request.

➤ Kwikset rekeyable 5 pin cylinder.

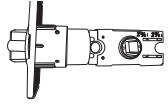
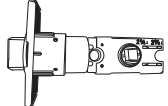
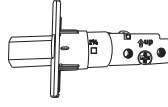
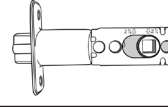
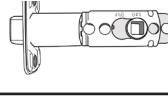
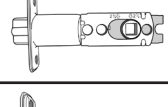
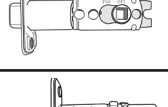
➤ **ADDITIONAL PARTS FOR CHELSIE, CONTEMPORARY, AND SUMMIT SERIES**

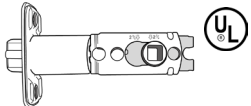
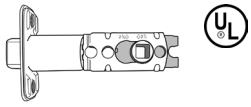
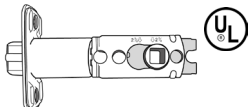
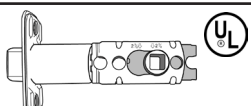
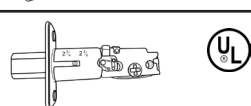
ILLUSTRATION	ITEM #	DESCRIPTION
	4DRIVE2-1	Entrance Four Way Adjustable Drive In Latch bolt, with removable Square Corner faceplate for knobsets
	4DRIVE2-2	Entrance Four Way Adjustable Drive In Latch bolt, with removable Square Corner faceplate for leversets
	4DRIVP2-1	Privacy, Passage Four Way Adjustable Drive In Latch bolt, with removable Square Corner faceplate for knobsets
	4DRIVP2-2	Privacy, Passage Four Way Adjustable Drive In Latch bolt, with removable Square Corner faceplate for leversets
	4DRIV31	Deadbolt Four Way Adjustable Drive-In Latch bolt, with removable Square Corner faceplate
	ENTK-4	Adjustable Dead Latch 2 3/8" or 2 3/4" with round corner faceplate for Entrance Knobsets
	PASK-6	Adjustable Spring Latch 2 3/8" or 2 3/4" with round corner faceplate for Passage Knobsets
	ENTL-5	Adjustable Dead Latch 2 3/8" or 2 3/4" with round corner faceplate for Entrance Leversets
	PASL-7	Adjustable Spring Latch 2 3/8" or 2 3/4" with round corner faceplate for Passage Leversets
	DB-8	Adjustable Deadbolt Latch 2 3/8" or 2 3/4" for Deadbolts
<b>FOR USE with UL-Listed Chelsie Series Leversets and Deadbolts ONLY (MAY, SOP, LEN, BRI, AUS and ULED-500)</b>		
	ULENTK-4	UL-Listed Adjustable Dead Latch 2 3/8" or 2 3/4" with round corner faceplate for Entrance Knobsets
	ULPASK-6	UL-Listed Adjustable Spring Latch 2 3/8" or 2 3/4" with round corner faceplate for Passage Knobsets
	ULENTL-5	UL-Listed Adjustable Dead Latch 2 3/8" or 2 3/4" with round corner faceplate for Entrance Leversets
	ULPASL-7	UL-Listed Adjustable Spring Latch 2 3/8" or 2 3/4" with round corner faceplate for Passage Leversets
	ULDB-8	UL-Listed Adjustable Deadbolt Latch 2 3/8" or 2 3/4" for Deadbolts

► **ADDITIONAL PARTS FOR CHELSIE, CONTEMPORARY, AND SUMMIT SERIES**

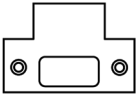
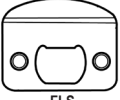
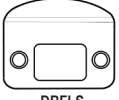
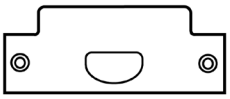
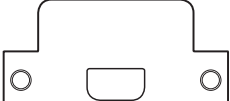
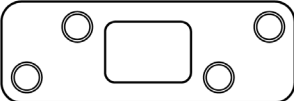
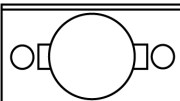
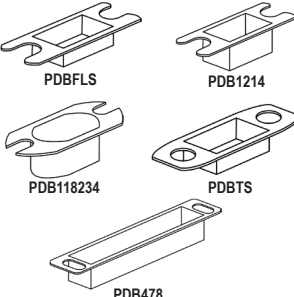
ILLUSTRATION	ITEM #	DESCRIPTION
	TS	T-Strike
	FLS	Full Lip Strike
	DBFLS	Deadbolt Full Lip Strike, Round Corner
	<b>ASAST</b> US3, 26D, 26	ANSI ASA Strike
	<b>ASAST</b> US10B, 10	ANSI ASA Strike
	EXASA-175 US32D, DURO	Extended Lip ANSI Strike 1 3/4" Lip Extension from Screw Center Line
	SS114358	Security Strike 1 1/4" X 3 5/8", 1/4" Rad With 2 pcs. each of 3" and 1 1/4" Screws US3, 5, 25, 26D, 10B
	K1-KEY	Blank Keys K1
	KEYS	Extra Cut Keys
	LFA18	Latch Front Adapter To Convert 1" Faceplate To 1 1/8" Wide Door Preparation
	PDBFLS	Plastic Dust box for Full Lip Strike, 1" x 2 1/8", 7/16" Depth
	PDB1214	Plastic Dust box for Residential Deadbolt Strike, 15/16" x 2 1/8", 1" Depth
	PDB118234	Plastic Dust box for T-Strike, 1 1/16" x 2 3/4", 1" Depth
	PDBTS	Plastic Dust box for Deadbolt T2STRK Strike, 1 1/16" x 2 3/4", 1/2" Depth
	PDB478	Plastic Dust box for ASA Strike, 1 3/16" x 4 7/8", 15/16" Depth
<b>◆ KEYING KITS</b>		
	KKWI200	Keying Kit - KWI Keyway
<b>◆ MOUNT</b>		
	RESMOUNT	3 Hole Mount For Residential Locks

**KEYING**

ITEM #	DESCRIPTION
KARES	Key alike
MKRES	Master key (Including KA)
CMKRES	Builder construction master key (Including KA & MK)
GMKRES	Grand master key (Including KA, MK)

## VANGUARD Series

### ANSI STANDARD A156.2 RESIDENTIAL LEVERS & A156.5 DEADBOLTS, GRADE 3

► **KEYWAYS ( STD, "KW" 5-PIN KWIKSET ) OPTIONAL 5-PIN SCHLAGE "C" & WEISER**

- All locksets, and deadbolts are available with **Schlage "C"** and **Weiser** keyway on special factory order only. Consult factory.
- **SCHLAGE "C" KEYWAY OPTION:**  
Prefix C before Part # (Ex: MOD-00 with C keyway is CMOD-00)
- **WEISER KEYWAY OPTION:**  
Prefix "W" before Part # (Ex: MOD-00 with Weiser keyway is WMOD-00)

► **LEVERSET DESIGNS**

► **DEADBOLT DESIGNS**

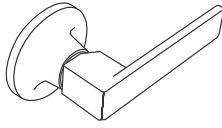
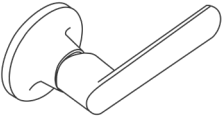
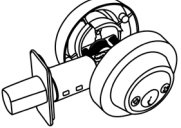
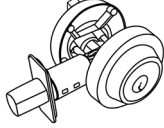
			
<b>MOD</b>	<b>NOV</b>	<b>AVA400</b>	<b>AVA500</b>
MODERNE	NOVUS	AVANTI	

**STOCK ITEM IN BOLD**  
NON-STOCK FINISH AND DESIGNS AVAILABLE WITH FACTORY LEAD TIME AND SUBJECT TO MINIMUM ORDER

**MODERNE ----- MOD SERIES**

FUNCTIONS	ANSI	ITEM #	FINISH							PCS / MC
Entry - KA / 3	F109	MOD-00	<b>US11P</b>	<b>US15</b>	<b>US26</b>	<b>US26D</b>	US3	US5	US15A	20
Storeroom - KA / 3	F86	MOD-05								
Privacy	F76	MOD-20								
Passage	F75	MOD-30								
Active Dummy	----	MOD-40								36

 Prefix "UL" before Part # when ordering UL Listed, available on Entrance and Passage functions.

**NOVUS ----- NOV SERIES**

FUNCTIONS	ANSI	ITEM #	FINISH							PCS / MC
Entry - KA / 3	F109	NOV-00	<b>US11P</b>	<b>US15</b>	<b>US26</b>	<b>US26D</b>	US3	US5	US15A	20
Storeroom - KA / 3	F86	NOV-05								
Privacy	F76	NOV-20								
Passage	F75	NOV-30								
Active Dummy	----	NOV-40								36

 Prefix "UL" before Part # when ordering UL Listed, available on Entrance and Passage functions.

**AVANTI ----- AVA SERIES**

FUNCTIONS	ANSI	ITEM #	FINISH							PCS / MC
Single Cylinder Deadbolt - KA / 3	E0153	AVA500	<b>US11P</b>	<b>US15</b>	<b>US26</b>	<b>US26D</b>	US3	US5	US15A	36
Double Cylinder Deadbolt - KA / 3	E0143	AVA400								

► **LEVERSET PACKAGING INCLUDES**

- Kwikset rekeyable 5 pin cylinder
- **6-way** 2 3/8" or 2 3/4" adjustable backset, size 1" x 2 1/4" round corner standard. Square corner option and drive-in latchbolt also available on special factory order.
- Round Corner Full Lip Strike: 1 3/4" x 2 1/4"
- Keyed entry comes with lever / lever for exterior and interior
- 1" bore diameter for latch, 2 1/8" diameter for lock housing

► **DEADBOLT PACKAGING INCLUDES:**

- Kwikset rekeyable 5 pin cylinder
- **6-way** 2 3/8" or 2-3/8" or 2 3/4" adjustable backset, size 1" x 2 1/4" round corner standard, convertible to drive in latch
- Full 1" throw deadbolt
- 1" x 2 1/4" round corner strike standard

## ITALIA Series

**STAINLESS STEEL LOCKSETS, KNOBSETS,  
ESCUTCHEONS, ANSI STANDARD A156.2, GRADE 3  
OPTIONAL GRADE 2**

HOW TO ORDER					
ddd-FFb-[H]R US32X					
DESIGN (ddd)	FUNCTION (FF)	BACKSET (b)	HANDING (H)	ROSE (R)	FINISH (US32X)
See Lever / Knob Designs in the table below	00 - Entrance 20 - Privacy 30 - Passage 40 - Single Dummy	8 - 2 3/8" (standard) 4 - 2 3/4" 2 - Gr. 2 (Passage) 2H - Gr 2 (L / R - Privacy) 2V - Gr. 2 (RHR/LHR -Privacy)	L - Left Hand R - Right Hand SPECIFY for Handed Levers or Scudo Privacy	G - Giro Q - Quadro S - Scudo	US32D - Satin SS US32 - Polished SS

**ROSE DESIGNS**



LEVER DESIGNS	FUNCTION + 2 3/8" BACKSET STD		HANDING	ROSE DESIGN				PCS / MC		UPGRADE AVAILABLE			
				G (ROUND)	Q (SQUARE)	S (ESCUTCHEON)		Q	S				
				FINISH				G	S				
LUCCA - LUC TURIN - TUR FERRARA - FER RAVENA - RAV *PISA - PIS	ENTRANCE w/ deadbolt	00	8	L / R *Handed	US32D	US32	US32D	US32	US32D	US32	24	6	GRADE 2
PRIVACY	20	8	36										
PASSAGE	30	8											
DUMMY (SINGLE)	40												



LEVER DESIGNS	FUNCTION + 2 3/8" BACKSET STD		HANDING	ROSE DESIGN				PCS / MC		UPGRADE AVAILABLE			
				G (ROUND)	Q (SQUARE)	S (ESCUTCHEON)		Q	S				
				FINISH				G	S				
PERUVIA - PER VENICE - VEN SALERNO - SAL POMPEI - POM SYRACUSE - SYR	ENTRANCE w/ deadbolt	00	8	Non-handed	US32D	US32	US32D	US32	US32D	US32	24	6	GRADE 2
PRIVACY	20	8	36										
PASSAGE	30	8											
DUMMY (SINGLE)	40												



**"Specify Handing when ordering Privacy function with Scudo rose design"**

ROSE DESIGNS

## ITALIA Series

### STAINLESS STEEL LOCKSETS, KNOBSETS, ESCUTCHEONS, ANSI STANDARD A156.2, GRADE 3 OPTIONAL GRADE 2



LEVER DESIGNS	FUNCTION + 2 3/8" BACKSET STD		HANDING	ROSE DESIGN						PCS / MC		UPGRADE AVAILABLE	
				G (ROUND)		Q (SQUARE)		S (ESCUTCHEON)		Q	S		
				FINISH						G	S		
<b>SOLID LEVER DESIGNS</b> *SIENA - SIE *LIVORNO - LIV *VICENZA - VIC BRESCIA - BRE	ENTRANCE w/ deadbolt	00	8	L / R *Handed									GRADE 2
	PRIVACY	20	8		US32D	US32	US32D	US32	US32D	US32	24	6	
	PASSAGE	30	8										
	DUMMY (SINGLE)	40									36		



LEVER DESIGNS	FUNCTION + 2 3/8" BACKSET STD		HANDING	ROSE DESIGN						PCS / MC		UPGRADE AVAILABLE	
				G (ROUND)		Q (SQUARE)		S (ESCUTCHEON)		Q	S		
				FINISH						G	S		
<b>KNOB DESIGNS</b> PADERNO - PAD PALERMO - PAL PAVIA - PAV	ENTRANCE w/ deadbolt	00	8	Non-handed									GRADE 2
	PRIVACY	20	8		US32D	US32	US32D	US32	US32D	US32	24	6	
	PASSAGE	30	8										
	DUMMY (SINGLE)	40									36		

► **STANDARD PACKAGING INCLUDES**

**GIRO AND QUADRO ROSE STYLE LEVERSETS / KNOBSETS**

- Non-handed 2 3/8" backset (2 1/4" x 1" faceplate) square corner, standard
- Full lip strike round corner 1/4" radius, T-Strike, 1 1/8" x 2" square corner

**SCUDO ESCUTCHEON STYLE**

- Schlage "C" 5-pin cylinder on deadbolt (Entrance Function)
- Non-handed 2 3/8" backset (2 1/4" x 1" faceplate) square corner, standard
- Full lip strike round corner 1/4" radius, T-Strike, 1 1/8" x 2" square corner

► **OPTIONS**

- Optional 2 3/4" backset and 4-way, Adjustable Grade 2 Drive-in latch bolt
- See PARTS and ACCESSORIES on page L94

**\*\*Specify Handing when ordering Privacy function with Scudo rose design**



- HANDED



- HOLLOW



- SOLID

► **ADDITIONAL PARTS FOR ITALIA SERIES**

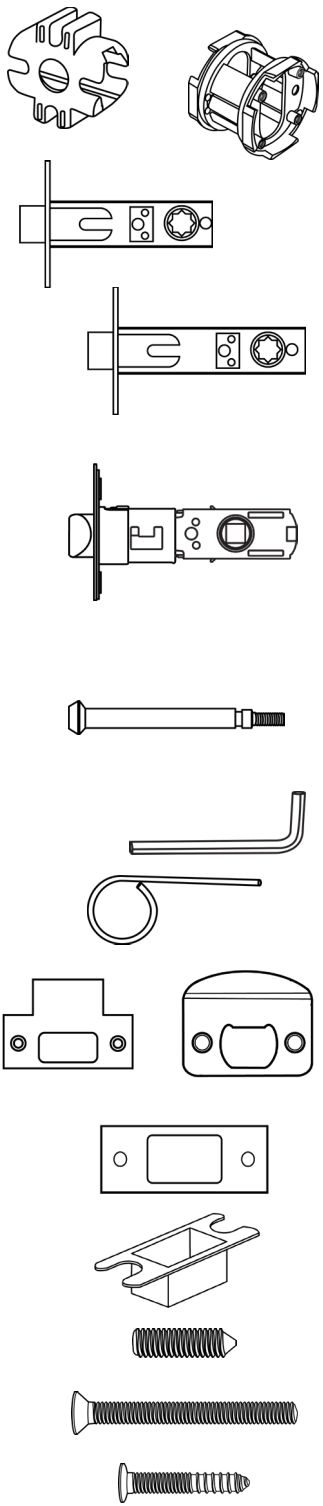
ILLUSTRATION	ITEM#	DESCRIPTION	UOM
	APS PVC	Anti-pry Shield PVC material	EACH
	APS ZINC	Anti-pry Shield Zinc material	
	CTPAS238	Passage 2 3/8" backset (fixed)	
	CTPRI238	Privacy 2 3/8" backset (fixed)	
	CTPAS234	Passage 2 3/4" backset (fixed)	
	CTRPRI234	Privacy 2 3/4" backset (fixed)	
	G2PAS	Grade 2 (4-way) Passage Adjustable 2 3/8" and 2 3/4" backset (non-handed)	
	G2PRILR	Grade 2 (4-way) Handed Privacy Adjustable 2 3/8" and 2 3/4" backset (L / R). Used for Escutcheon Privacy (SCU)	
	G2PRIIO	Grade 2 (4-way) Handed Privacy Adjustable 2 3/8" and 2 3/4" backset (LHR / RHR). Used for Escutcheon Privacy (SCU)	
	CTPRIPIN US32D	Privacy Pin Satin Stainless Steel Finish	
	CTPRIPIN US32	Privacy Pin Polished Stainless Steel Finish	
	ALLENKEY	Allen Key	
	EMRELPIN	Emergency Release Pin	
	TS	T-Strike (1 1/8" x 2 3/4", with lip 1 1/2" x 1/2")	
	FLS	Full Lip Strike (1 3/4" x 2 1/4", 1/4" Corner)	
	ITA-FP US32D	Latch Face Plate Italia Series (1 3/4" x 2 1/4")	
	ITA-FP US32	Latch Face Plate Italia Series (1 3/4" x 2 1/4")	
	ITA-SB	Plastic Strike Box Italia Series	
	ITA-SETSCREW	M4 x 0.7 Lever / Knob set screws Italia Series	
	ITA-SCREWPACK	8-32 x 1 1/2" Screws for lock body Italia Series (PAIR)	PAIR
ITA-COMBISCREW	8-32 x 1" Combination metal-wood screws Italia Series (PAIR)		

► For Keying see page L115.



## ITALIA Series

STAINLESS STEEL MORTISE LOCKS, ANSI STANDARD A156.2, GRADE 1

FUNCTIONS	ANSI	FINISH		PCS / MC
<b>◀ Single cylinder without deadbolt</b>				
NM8050 - Office / Entrance	F04	US32D	US32	6
NM8070 - Classroom	F05			
NM8080 - Storeroom	F07			
<b>◀ Single cylinder with deadbolt</b>				
NM8453 - Entrance	F20	US32D	US32	6
NM8456 - Corridor	F13			
NM8495 - Keyed Privacy w/ Indicator	----	US32D		
NM8465 - Closet / Storeroom	----	US32D		
NM8473 - Dormitory / Bedroom	F21			
<b>◀ Double cylinder without deadbolt</b>				
NM8060 - Apartment Entrance	F09	US32D	US32	6
NM8082 - Institution	F30			
<b>◀ Double cylinder with deadbolt</b>				
NM8466 - Storeroom	F14			
<b>◀ Other Functions</b>				
NM8040 - Privacy with Deadbolt	F02,F19,F22	US32D	US32	6
NM8445 - Privacy with Indicator	----	US32D		
NM8010 - Passage	F01	US32D		

 All keyed lock functions are available with **Best, Falcon and Arrow, Schlage, Corbin / Russwin, Sargent, and Yale Large Format Interchangeable Cores**. For IC Core see pages L105 – L106. For Keying see page L115.

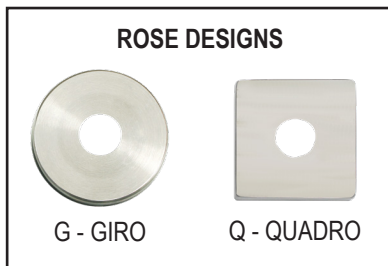

**ORDERING FOR NM SERIES MORTISE LOCK**

The Lever and Knob designs can also be used for our NM Series Mortise Locks. To order, refer to functions in the NM Series page and choose a function, indicate handing, lever / knob design, rose design (G or Q) and finish: **NMnnnnHH-ddd-r US32x**  
 e.g. :

To order NM8080 function LH in SIENA lever design with round rose in US32D finish use:

**NM8080LH-SIE-G US32D**

# ITALIA Series

## STAINLESS STEEL DEADBOLTS WITH GRADE 1 LATCH

### ANSI STANDARD A156.5, GRADE 3

- ▶ KEYWAY standard 5-PIN SCHLAGE "C"
  - Latch Bolt: Grade 1, 4-way Drive-In, Brass, Satin Nickel bolt
  - Latch Backset: Adjustable 2 3/8 (60) and 2 3/4 (70)
  - Handing: Non-Handed
  - Latch Faceplate: 1" x 2 1/4" (25 x 57)
  - Deadbolt Strike: 1 1/8" x 2 3/4" (29 x 70) square corner (standard)
  - Security Strike: 1 1/8" x 2 3/4" x 3/32" (29 x 70 x 2) (standard)
  - Keying service available

▶ **DEADBOLT DESIGNS**

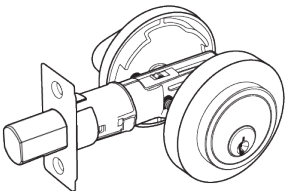
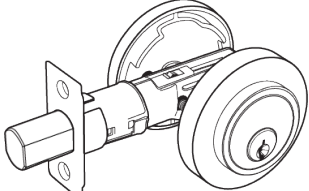
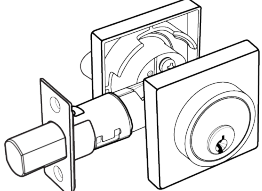
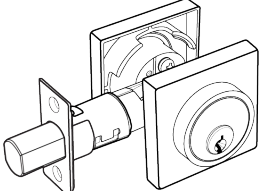
			
<b>RND-504 / RND-508</b> SINGLE CYLINDER	<b>RND-404</b> DOUBLE CYLINDER	<b>SQR-504 / SQR-508</b> SINGLE CYLINDER	<b>SQR-404</b> DOUBLE CYLINDER
ROUND		SQUARE	

**DEADBOLT ----- ITALIA SERIES**

FUNCTIONS	ANSI	ITEM #	FINISH		PCS / MC
Single Cylinder Round Deadbolt for 1 3/4" Door Thickness	E0153	RND-504	<b>US32D</b>	<b>US32</b>	<b>18</b>
Single Cylinder Round Deadbolt for 1 3/8" Door Thickness	E0153	RND-508			
Single Cylinder Square Deadbolt for 1 3/4" Door Thickness	E0153	SQR-504			
Single Cylinder Square Deadbolt for 1 3/8" Door Thickness	E0153	SQR-508			
Double Cylinder Round Deadbolt for 1 3/4" Door Thickness	E0143	RND-404			
Double Cylinder Square Deadbolt for 1 3/4" Door Thickness	E0143	SQR-404			

▶ For Keying see page L115.

## HERITAGE Series

### RESIDENTIAL LEVERS AND DEADBOLTS

### ANSI STANDARD A156.2, GRADE 3

► **KEYWAYS** ( STD, "KW" 5-PIN KWIKSET ) OPTIONAL 5-PIN SCHLAGE "C" & WEISER

- All locksets and deadbolts are available with **Schlage "C"** and **Weiser** keyway on special factory order only. Consult factory
- **SCHLAGE "C" KEYWAY OPTION:**  
Prefix "C" before Part # (Ex: AZU-00 with C keyway is CAZU-00)
- **WEISER KEYWAY OPTION:**  
Prefix "W" before Part # (Ex: AZU-00 with Weiser keyway is WAZU-00)

► **LEVERSET DESIGNS**

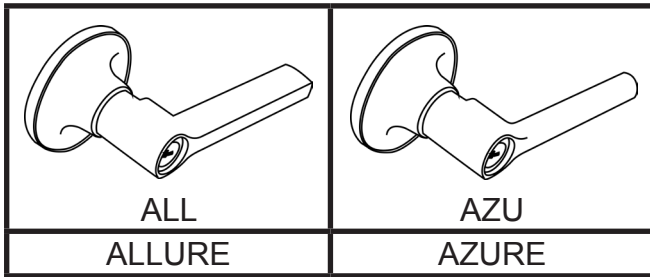

**STOCK ITEM IN BOLD**

NON-STOCK FINISH AND DESIGNS AVAILABLE WITH FACTORY LEAD TIME AND SUBJECT TO MINIMUM ORDER

**AZURE ----- AZU SERIES**

FUNCTIONS	ANSI	ITEM #	FINISH							PCS / MC
Entry - KA / 3	F109	AZU-00	US3	US5	<b>US11P</b>	<b>US15</b>	US15A	<b>US26</b>	<b>US26D</b>	24
Storeroom - KA / 3	F86	AZU-05								
Privacy	F76	AZU-20								
Passage	F75	AZU-30								
Active Dummy	----	AZU-40								36

Prefix "UL" before Part # when ordering UL Listed, available on Entrance and Passage functions.

**ALLURE ----- ALL SERIES**

FUNCTIONS	ANSI	ITEM #	FINISH							PCS / MC
Entry - KA / 3	F109	ALL-00	US3	US5	<b>US11P</b>	<b>US15</b>	US15A	<b>US26D</b>	<b>US26D</b>	24
Storeroom - KA / 3	F86	ALL-05								
Privacy	F76	ALL-20								
Passage	F75	ALL-30								
Active Dummy	----	ALL-40								36

Prefix "UL" before Part # when ordering UL Listed, available on Entrance and Passage functions.

► **LEVERSET PACKAGING INCLUDES**

- Kwikset rekeyable 5-pin cylinder
- 2 3/8" or 2 1/4" adjustable backset, size 1" x 2 1/4" round corner standard  
Square corner option and drive-in latchbolt also available on special factory order
- Round Corner Full Lip Strike: 1 3/4" x 2 1/4"
- Keyed entry comes with lever / lever for exterior and interior
- 1" bore diameter for latch, 2 1/8" diameter for lock housing

**5 Year Finish Warranty**  
**25 Year Mechanical Warranty**

## LEGACY Series

### RESIDENTIAL LEVERS A156.2, GRADE 3

► **KEYWAYS ( STD, "KW" 5-PIN KWIKSET ) OPTIONAL 5-PIN SCHLAGE "C" & WEISER**

► All locksets and deadbolts are available with **Schlage "C"** and **Weiser** keyway on special factory order

► **SCHLAGE "C" KEYWAY OPTION:**

Prefix "C" before Part # (Ex: ZUL00 with C keyway is CZUL00)

► **WEISER KEYWAY OPTION:**

Prefix "W" before Part # (Ex: ZUL00 with Weiser keyway is WZUL00)

► Prefix "UL" before Part # when ordering UL Listed, available on Entrance, Storeroom, Privacy, Passage and Deadbolt functions.



**STOCK ITEM IN BOLD**  
 NON-STOCK FINISH AND DESIGNS AVAILABLE WITH FACTORY LEAD TIME AND SUBJECT TO MINIMUM ORDER

#### GABERNET ----- CAB DESIGN

	FUNCTIONS	ANSI	ITEM #	FINISH						PCS / MC
	Entrance w/ Push Button	F109	CAB00	<b>US15</b>	<b>US26D</b>	<b>US11P</b>	US5	15A / 26	US3	24
	Storeroom	F86	CAB05							
	Privacy w/ Push Button	F76	CAB20							
	Passage	F75	CAB30							
	Dummy	--	CAB40							

#### ZULU ----- ZUL DESIGN

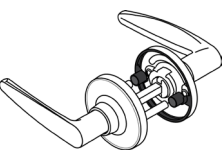
	FUNCTIONS	ANSI	ITEM #	FINISH						PCS / MC
	Entrance w/ Push Button	F109	ZUL00	<b>US15</b>	<b>US26D</b>	<b>US11P</b>	US5	15A / 26	US3	24
	Storeroom	F86	ZUL05							
	Privacy w/ Push Button	F76	ZUL20							
	Passage	F75	ZUL30							
	Dummy	--	ZUL40							

#### DUCATI ----- DUC DESIGN

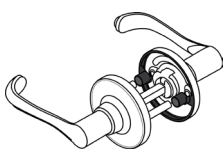
	FUNCTIONS	ANSI	ITEM #	FINISH						PCS / MC
	Entrance w/ Push Button	F109	DUC00	<b>US15</b>	<b>US26D</b>	<b>US11P</b>	US5	15A / 26	US3	24
	Storeroom	F86	DUC05							
	Privacy w/ Push Button	F76	DUC20							
	Passage	F75	DUC30							
	Dummy	--	DUC40							

#### NAPA ----- NAP DESIGN

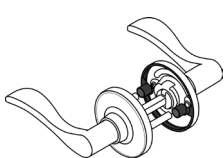
	FUNCTIONS	ANSI	ITEM #	FINISH						PCS / MC
	Entrance w/ Push Button *SH	F109	NAP00	<b>US15</b>	<b>US26D</b>	<b>US11P</b>	US5	15A / 26	US3	24
	Storeroom *SH	F86	NAP05							
	Privacy w/ Push Button *SH	F76	NAP20							
	Passage *SH	F75	NAP30							
	Dummy *SH	--	NAP40							

\*SH is for Specify Handing

**DENMARK ----- DEN DESIGN**

	FUNCTIONS	ANSI	ITEM #	FINISH						PCS / MC
	Entrance w/ Push Button	F109	DEN00	US15	US26D	US11P	US5	15A / 26	US3	24
	Storeroom	F86	DEN05							24
	Privacy w/ Push Button	F76	DEN20							24
	Passage	F75	DEN30							24
	Dummy	--	DEN40							24

**VIARGENTO ----- VIA DESIGN**

	FUNCTIONS	ANSI	ITEM #	FINISH						PCS / MC	
	Entrance w/ Push Button *SH	F109	VIA00	US15	US26D	US11P	US5	15A / 26	US3	24	
	Storeroom	*SH	F86							VIA05	24
	Privacy w/ Push Button *SH	F76	VIA20							24	
	Passage	*SH	F75							VIA30	24
	Dummy	*SH	--							VIA40	24

\*SH is for Specify Handing

► **LEVERSET PACKAGING INCLUDES**

- 2 3/8" or 2 3/4" 4-way adjustable backset, size 1" x 2 1/4" round corner standard, convertible to drive-in latch. Square corner face plate and 5" round corner backsets optional.
- All locksets are packed with full lip strike round corner 1/4" radius
- Screw Guiding Posts for easy screw alignment and tightening making installation fast and easy.
- Push button release on entrance and privacy from inside by turning lever.
- Kwikset rekeyable 5 pin cylinder

## CLIPPER Series

### RESIDENTIAL DEADBOLTS A156.5, GRADE 3



**STOCK ITEM IN BOLD**  
NON-STOCK FINISH AND DESIGNS AVAILABLE WITH FACTORY LEAD TIME AND SUBJECT TO MINIMUM ORDER

	FUNCTIONS	ITEM #	FINISH						PCS / MC
	Single Cylinder Deadbolt	CLP500	US15	US26D	US11P	US3	US5	24	
	Double Cylinder Deadbolt	CLP400	US15	US26D	US11P	US3	US5	24	
	One Sided Deadbolt with Cover	CLP801	US15	US26D	US11P	US3	US5	24	
	One Sided Deadbolt	CLP701	US15	US26D	US11P	US3	US5	24	

Optional UL Listed Latch.

► **DEADBOLT PACKAGING INCLUDES:**

- 2 3/8" or 2 3/4" 4-way adjustable backset, size 1" x 2 1/4" round corner standard, convertible to drive-in latch. Square corner face plate and 5" round corner backsets optional.
- Deadbolts packed with 1" x 2 1/4" strike round corner 1/4" radius and full lip strike 1/4" radius. Square corner available upon request.
- Security strike (1 1/4" x 3 5/8" x 1/4" radius) with 3" screws available upon request.
- Kwikset rekeyable 5 pin cylinder

► **ADDITIONAL PARTS FOR VANGUARD, HERITAGE, LEGACY, AND CLIPPER SERIES**

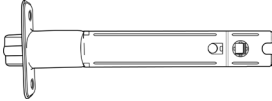
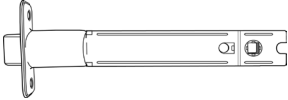
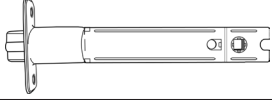
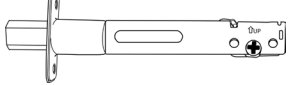
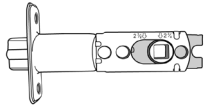
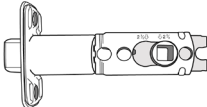
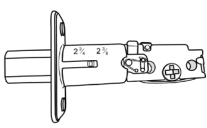
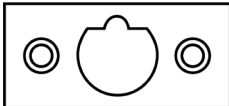
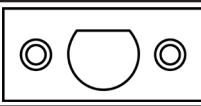
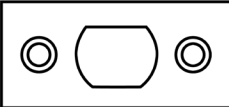
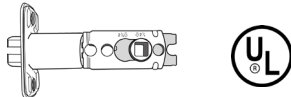
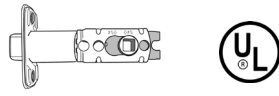
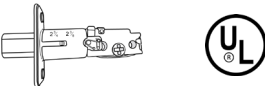
ILLUSTRATION	ITEM#	DESCRIPTION
	LGEM-5 US32D	5" Entrance Deadlatch Round Corner for Legacy Series
	LGEM-5 US11P	5" Entrance Deadlatch Round Corner for Legacy Series
	LGPA-5 US32D	5" Privacy / Passage Spring Latch Round Corner for Legacy Series
	LGPA-5 US11P	5" Privacy / Passage Spring Latch Round Corner for Legacy Series
	LGST-5 US32D	5" Storeroom Dead Latch Round Corner for Legacy Series
	LGST-5 US11P	5" Storeroom Dead Latch Round Corner for Legacy Series
	LGDB-5 US32D	5" Deadbolt Latch Round Corner for Legacy Series
	LGDB-5 US11P	5" Deadbolt Latch Round Corner for Legacy Series
	LGEM-1 US32D	Adjustable Entrance 4-Way Dead Latch 2 3/8" or 2 3/4" Round Corner w/ Drive-in Collar for Legacy Series
	LGEM-1 US11P	Adjustable Entrance 4-Way Dead Latch 2 3/8" or 2 3/4" Round Corner w/ Drive-in Collar for Legacy Series
	LGPA-3 US32D	Adjustable Privacy / Passage 4-Way Spring Latch 2 3/8" or 2 3/4" Round Corner w/ Drive-in Collar for Legacy Series
	LGPA-3 US11P	Adjustable Privacy / Passage 4-Way Spring Latch 2 3/8" or 2 3/4" Round Corner w/ Drive-in Collar for Legacy Series
	LGDB-2 US32D	Adjustable 4-Way Deadbolt Latch 2 3/8" or 2 3/4" Round Corner w/ Drive-in Collar for Legacy Series
	LGDB-2 US11P	Adjustable 4-Way Deadbolt Latch 2 3/8" or 2 3/4" Round Corner w/ Drive-in Collar for Legacy Series
	LGSCEN-9 US32D	Square Corner Faceplate for Storeroom / Entrance Legacy Series
	LGSCEN-9 US11P	Square Corner Faceplate for Storeroom / Entrance Legacy Series
	LGSCPP-8 US32D	Square Corner Faceplate for Privacy / Passage Legacy Series
	LGSCPP-8 US11P	Square Corner Faceplate for Privacy / Passage Legacy Series
	LGSCDB-7 US32D	Square Corner Faceplate for Deadbolt Legacy Series
	LGSCDB-7 US11P	Square Corner Faceplate for Deadbolt Legacy Series
	ULLGEN-1	UL-Listed Adjustable Dead Latch 2 3/8" or 2 3/4" with round corner faceplate for Entrance and Storeroom Leversets
	ULLGPAS-3	UL-Listed Adjustable Spring Latch 2 3/8" or 2 3/4" with round corner faceplate for Privacy and Passage Leversets
	ULLGDB-2	UL-Listed Adjustable Deadbolt Latch 2 3/8" or 2 3/4" for Deadbolts

► **ADDITIONAL PARTS FOR VANGUARD, HERITAGE, LEGACY, AND CLIPPER SERIES**

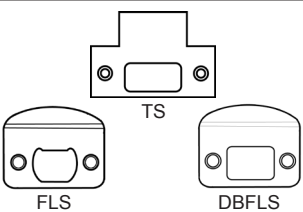
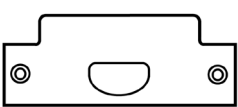
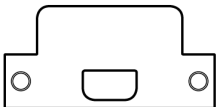
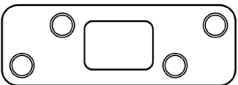
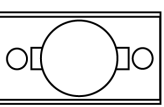
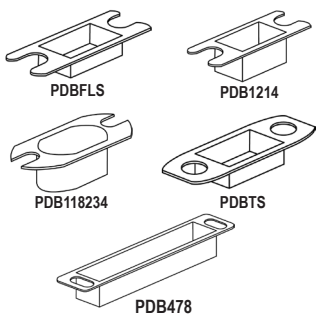
ILLUSTRATION	ITEM#	DESCRIPTION
	TS	T-Strike
	FLS	Full Lip Strike
	DBFLS	Deadbolt Full Lip Strike, Round Corner
	<b>ASAST</b> US3, 26D, 26	ANSI ASA Strike
	<b>ASAST</b> US10B, 10	ANSI ASA Strike
	EXASA-175 US32D, DURO	Extended Lip ANSI Strike 1 3/4" Lip Extension from Screw Center Line
	SS114358	Security Strike 1 1/4" x 3 5/8", 1/4" Rad With 2pcs each of 3" and 1 1/4" Screws US3, 5, 25, 26D, 10B
	K1-KEY	Blank Keys K1
	KEYS	Extra Cut Keys
	LFA18	Latch Front Adapter To Convert 1" Faceplate To 1 1/8" Wide Door Preparation
	PDBFLS	Plastic Dust box for Full Lip Strike, 1" x 2 1/8", 7/16" Depth
	PDB1214	Plastic Dust box for Residential Deadbolt Strike, 15/16" x 2 1/8", 1" Depth
	PDB118234	Plastic Dust box for T-Strike, 1 1/16" x 2 3/4", 1" Depth
	PDBTS	Plastic Dust box for Deadbolt T2STRK Strike, 1 1/16" x 2 3/4", 1/2" Depth
	PDB478	Plastic Dust box for ASA Strike, 1 3/16" x 4 7/8", 15/16" Depth
◆ <b>KEYING KITS</b>		
	KKWI200	Keying Kit - KWI Keyway
◆ <b>MOUNT</b>		
	RESMOUNT	3 Hole Mount For Residential Locks

**KEYING**

ITEM #	DESCRIPTION
KARES	Key alike
MKRES	Master key
CMKRES	Builder construction master key
GMKRES	Grand master key (Including KA, MK)

## REPLACEMENT CYLINDERS . . .

- Made to Original Manufacturers' Keying Specifications
- All Cylinders drilled for 6-pins
- Can be keyed with original pins
- Packed with appropriate accessories

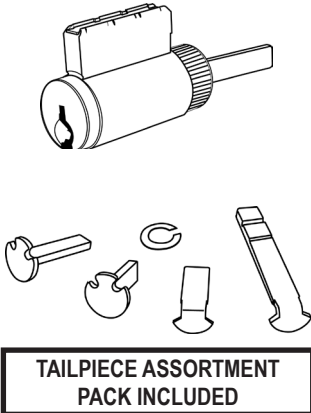
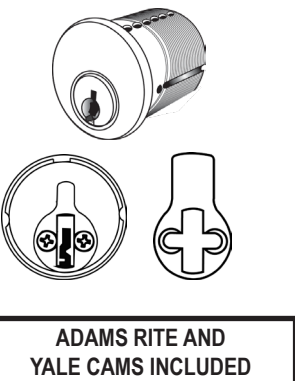
ILLUSTRATION	ITEM#	DESCRIPTION	KEYED	FINISH
<b>KEY-IN-KNOB/LEVER &amp; DEADBOLT CYLINDER (Packed with tailpiece assortment pack)</b>				
 <p><b>TAILPIECE ASSORTMENT PACK INCLUDED</b></p>	KKARA-4	6-pin Arrow "A"	5-pin	US26D
	KKC59-4	6-pin Corbin 60 Russwin 59	5-pin	
	KKCL4-4	6-pin Corbin L1 thru L4	6-pin	
	KKKW5-4	6-pin Kwikset	5-pin	
	KKRD1-4	6-pin Russwin D-1 thru 4	6-pin	
	KKSCC-4	6-pin <b>Schlage</b> "C"	6-pin	
	KKSCE-4	6-pin <b>Schlage</b> "E"	6-pin	
	KKSCF-4	6-pin <b>Schlage</b> "F"	6-pin	
	KKSCP-4	6-pin <b>Schlage</b> C-K	5-pin	
	KKSLA-4	6-pin <b>Sargent</b> "LA" thru "LC"	6-pin	
	KKSRA-4	6-pin <b>Sargent</b> "RA"	6-pin	
	KKWFE-4	6-pin Weiser / Falcon "E"	5-pin	
	KKYA8-4	6-pin Yale 8 (E1R)	5-pin	
KKYGA-4	6-pin Yale "GA"	6-pin		
<b>1-1/4" MORTISE CYLINDERS (Packed with Adams Rite and Yale Cams)</b>				
 <p><b>ADAMS RITE AND YALE CAMS INCLUDED</b></p>	KMARA-4	6-pin Arrow "A"	5-pin	US26D
	KMC59-4	6-pin Corbin 60 Russwin 59	5-pin	
	KMCL4-4	6-pin Corbin L1 thru L4	6-pin	
	KMKW5-4	6-pin Kwikset	5-pin	
	KMRD1-4	6-pin Russwin D-1 thru 4	6-pin	
	KMSCC-4	6-pin <b>Schlage</b> "C"	6-pin	
	KMSCE-4	6-pin <b>Schlage</b> "E"	6-pin	
	KMSCF-4	6-pin <b>Schlage</b> "F"	6-pin	
	KMSCP-4	6-pin <b>Schlage</b> C-K	5-pin	
	KMSLA-4	6-pin <b>Sargent</b> "LA" thru "LC"	6-pin	
	KMSRA-4	6-pin <b>Sargent</b> "RA"	6-pin	
	KMWFE-4	6-pin Weiser / Falcon "E"	5-pin	
	KMYA8-4	6-pin Yale 8 (E1R)	5-pin	
KMYGA-4	6-pin Yale "GA"	6-pin		

► For KEYING see page L115



## REPLACEMENT CYLINDERS . . .

- Made to Original Manufacturers' Keying Specifications
- Can be keyed with original pins
- All Cylinders drilled for 6-pins
- Packed with appropriate accessories

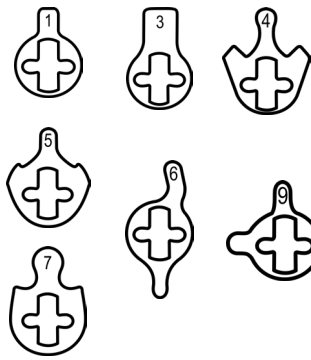
ILLUSTRATION	ITEM#	DESCRIPTION	FINISH
<b>MORTISE CYLINDER CAMS</b>			
	KC-S1	Mortise Cylinder Adams Rite Cam	---
	KC-S3	Mortise Cylinder Yale Mortise Lock Cam	
	KC-S4	Mortise Cylinder Russwin Mortise Lock Cam	
	KC-S5	Mortise Cylinder Falcon Mortise Lock Cam	
	KC-S6	Mortise Cylinder Cal-Royal Panic Trim Cam	
	KC-S7	Mortise Cylinder CRP Mortise Lock -- (NM Series)	
	KC-S9	Mortise Cylinder NESC Panic Trim	



<b>MORTISE CYLINDER ACCESSORIES</b>			
	THMBMORT100	1" Mortise Cylinder with Thumbturn	US26D US10B,3
	BLNKMORT100	1" Blank Mortise Cylinder	US26D US10B,3
	MCCR1814	Mortise Cylinder Compression Ring 1/8" to 1/4"	US3, US10B, US26D
	MCCR3812	Mortise Cylinder Compression Ring 3/8" to 1/2"	
	CGR175	Cylinder Guard Ring 1 3/4" base and 1/2" projection with Wave Washer and Spacing Collar	US26D, 10B, 3, 4
	MCRC250	Free Spinning Cylinder Guard Ring 1/4"	US3, 15, 26D, 10B

ILLUSTRATION	ITEM#	DESCRIPTION	KEYED	FINISH
<b>RIM CYLINDERS</b>				
 <div style="border: 1px solid black; padding: 5px; width: fit-content; margin-top: 10px;"> <b>MOUNTING PLATE AND SCREWS INCLUDED</b> </div>	KR-AR-A	Arrow "A"	5-pin	US26D
	KR-C-59	Corbin 60 Russwin 59	5-pin	
	KR-C-L4	Corbin L1 thru L4	6-pin	
	KR-KW-5	Kwikset	5-pin	
	KR-R-D1	Russwin D-1 thru 4	6-pin	
	KR-SC-C	<b>Schlage</b> "C"	6-pin	
	KR-SC-E	<b>Schlage</b> "E"	6-pin	
	KR-SC-F	<b>Schlage</b> "F"	6-pin	
	KR-SC-P	<b>Schlage</b> C-K	5-pin	
	KR-S-LA	<b>Sargent</b> "LA" thru "LC"	6-pin	
	KR-S-RA	<b>Sargent</b> "RA"	6-pin	
	KR-WF-E	Weiser / Falcon "E"	5-pin	
	KR-YA-8	Yale 8 (E1R)	5-pin	
	KR-Y-GA	Yale "GA"	6-pin	

► For KEYING see page L115

## RIM AND MORTISE CYLINDERS

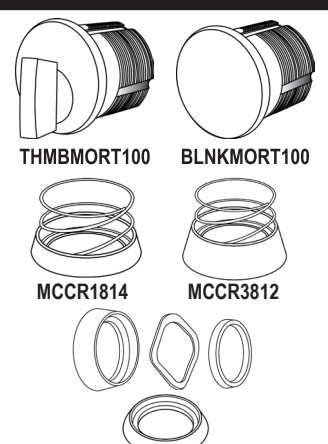
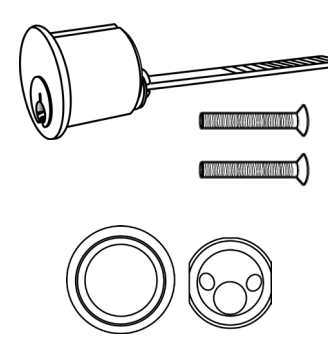
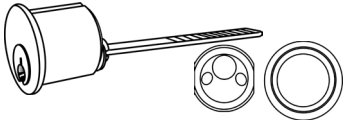
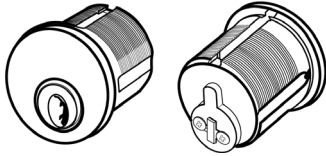
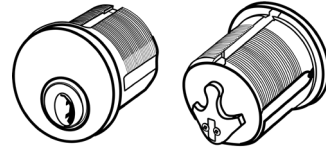
6-pin SCHLAGE "C" KEYWAY MORTISE AND RIM CYLINDERS			
ILLUSTRATION	ITEM #	DESCRIPTION	FINISH
	CX96RIMKD	6-pin <b>Schlage</b> "C" keyway 1 1/8" Rim Cylinder with mounting plate & screws	US26D
			US10B,3
	AMORTCYL118	6-pin <b>Schlage</b> "C" Keyway Mortise Cylinder 1 1/8" length, with ADAMS RITE cam	US26D
	AMORTCYL114	6-pin <b>Schlage</b> "C" Keyway Mortise Cylinder 1 1/4" length, with ADAMS RITE cam	US10B,3
	CMORTCYL118	6-pin <b>Schlage</b> "C" Keyway Mortise Cylinder 1 1/8" length, with CLOVER LEAF cam	US26D
	CMORTCYL114	6-pin <b>Schlage</b> "C" Keyway Mortise Cylinder 1 1/4" length, with CLOVER LEAF cam	US10B,3
<b>6-pin SCHLAGE "C" KEYWAY EUROPEAN PROFILE MORTISE CYLINDERS</b>			
 SINGLE CYLINDER	KE-SCC-S-A	Single Cylinder 45mm Schlage "C", 6-pin rekeyable	US15
	KE-SCC-D-C	Double Cylinder 60mm Schlage "C", 6-pin rekeyable	
 DOUBLE CYLINDER	KE-SCC-D-D	Double Cylinder 70mm Schlage "C", 6-pin rekeyable	
	KE-SCC-C-C	Single Cylinder with turn 60mm Schlage "C", 6-pin rekeyable	
 SINGLE CYLINDER WITH TURN	KE-SCC-C-D	Single Cylinder with turn 70mm Schlage "C", 6-pin rekeyable	
	KE-P-C	Bathroom Cylinder 60mm	
 BATHROOM CYLINDER	KE-P-D	Bathroom Cylinder 70mm	
<b>EASY REMOVABLE SCREW FOR RE-KEYING</b>			

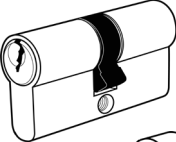
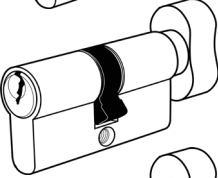
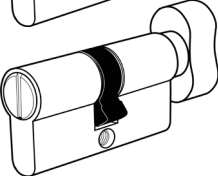
► For KEYING see page L115

## BEST / FALCON 6 & 7-PIN SMALL FORMAT INTERCHANGEABLE CORES (SFIC) HOUSING & KEY BLANKS

### KEY SECTIONS (A, B, C, D, E, F, G, H, J, K, L, M, Q, TB)

















\*All above keyways in stock for immediate shipment

**MEETS**  
*The Buy American Act*

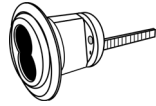
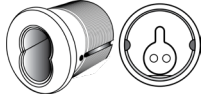

**Features:**

- Operates on Best / Falcon Small Format Interchangeable Cores locksets, deadbolts, rim and Mortise cylinders
- Operates on all of Cal-Royal's keyed locksets prepared for small format Best / Falcon A, B, C, D, E, F, G, H, J, K, L, M, Q, TB keyways

KEY SECTIONS	UNCOMBINATIONED	MASTER KEYED	KEY BLANKS
 A  B	*6PUC A (6-pins)	6PCCA-MK (6-pins)	KBSF-A
	*7PUC A (7-pins)	7PCC A-MK (7-pins)	KBSF-B
	7PUC B (7-pins)	7PCC B-MK (7-pins)	KBSF-C
 C  D	7PUC C (7-pins)	7PCC C-MK (7-pins)	KBSF-D
	7PUC D (7-pins)	7PCC D-MK (7-pins)	KBSF-E
 E  F	7PUC E (7-pins)	7PCC E-MK (7-pins)	KBSF-F
	7PUC F (7-pins)	7PCC F-MK (7-pins)	KBSF-G
 G  H	7PUC G (7-pins)	7PCC G-MK (7-pins)	KBSF-H
	7PUC H (7-pins)	7PCC H-MK (7-pins)	KBSF-J
 J  K  L	7PUC J (7-pins)	7PCC J-MK (7-pins)	KBSF-K
	7PUC K (7-pins)	7PCC K-MK (7-pins)	KBSF-L
	7PUC L (7-pins)	7PCC L-MK (7-pins)	KBSF-M
 M  Q  TB	7PUC M (7-pins)	7PCC M-MK (7-pins)	KBSF-Q
	7PUC Q (7-pins)	7PCC Q-MK (7-pins)	KBSF-TB
	7PUC TB (7-pins)	7PCC TB-MK (7-pins)	
ILLUSTRATION	ITEM #	DESCRIPTION	FINISH
	308-602	Best / Falcon and Arrow 6 / 7-pin Small Format Interchangeable Core Rim Cylinder with mounting plate & screws	US26D
			US10B,3
	307-601	Best / Falcon and Arrow 6 / 7-pin Small Format Interchangeable Core Mortise Cylinder, with <b>ADAMS RITE</b> cam, 1 1/4"	US26D
			US10B,3
	ICH961387	Best / Falcon and Arrow 6 / 7-pin Small Format Interchangeable Core Mortise Cylinder, <b>CLOVER LEAF</b> cam 1 1/4" length. To be used with <b>Cal-Royal NM Series</b> mortise locks	US26D
			US10B,3
ITEM #	CONSTRUCTION CORES		
ICCC	Temporary 6-pin construction cores are available.		
ICCC7	Temporary 7-pin construction cores are available.		
ICPTT	Plastic thumb turns available for non-secured areas.		

► Standard Master Key Cylinders. For other Keying see page L115.

## LARGE FORMAT 6-Pin INTERCHANGEABLE CORE (LFIC) & HOUSING

**Features:**

- Operates on all **Schlage, Sargent, Russwin, Yale Large Format Interchangeable Cores** locksets, deadbolts, rim and Mortise cylinders.
- Operates on Cal-Royal's Commander Grade 2 leversets with large format, Genesys Grade 1 leversets with Large Format IC Core, T220 Series deadbolts with Large Format IC Core.

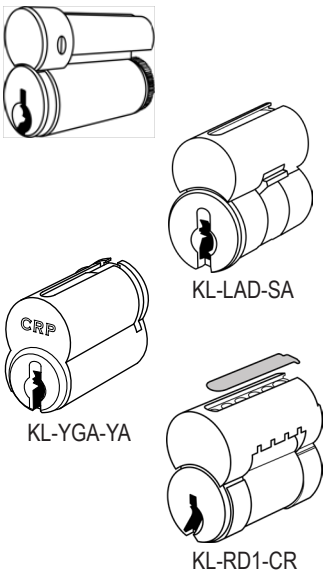
ILLUSTRATION	ITEM #	DESCRIPTION	FINISH
	3000 ICC	6-pin "C" keyway combined <b>Schlage</b> large format IC core cylinder KA# 111111 with "C" keys	US3, US26D
	4000 ICCK	6-pin "C-K" keyway combined <b>Schlage</b> large format IC core cylinder KA# 111111 with "E" keys	
	5000 ICE	6-pin "E" keyway combined <b>Schlage</b> large format IC core cylinder KA# 111111 with "E" keys	
	1000 ICC	6-pin "C" keyway combined <b>Schlage</b> large format IC core cylinder KD and MK	
	2000 ICC	Temporary 6-pin <b>Schlage</b> large format IC Core Construction Cores (Keyed Alike) will be charged on a separate memo billing for 6 months. On return to the factory credit will be issued.	
	KL-LAD-SA	<b>Sargent</b> LA-LB-LC LFIC 6-pin Uncombined	US26D
	KL-RD1-CR	<b>Corbin / Russwin</b> D1-D4 LFIC 6-pin Uncombined	US26D
	KL-YGA-YA	<b>YALE</b> GA LFIC 6-pin Uncombined	US26D

### LARGE FORMAT 6-pin INTERCHANGEABLE CORE MORTISE AND RIM CYLINDERS

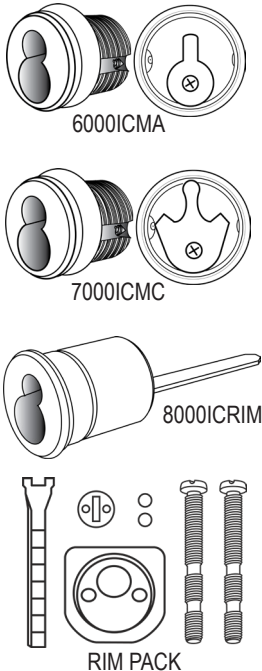

	6000 ICMA	<b>Schlage</b> Large Format Interchangeable Core Mortise Cylinder with <b>Adams Rite</b> Cam 1 1/2" long	US3, US10B, US26D
	7000 ICMC	<b>Schlage</b> Large Format Interchangeable Core Mortise Cylinder with <b>Cloverleaf</b> Cam 1 1/2" long. To be used with <b>Cal-Royal</b> NM Series Mortise locks	
	8000 ICRIM	<b>Schlage</b> Large Format Interchangeable Core rim Cylinder with mounting plate and screws	
	KM-LFH-SA	<b>Sargent</b> Large Format Interchangeable Core Mortise cylinder with Adams Rite Cam 1 1/2" long <b>OPTIONAL RIM PACK</b>	US26D
	KM-LFH-CR	<b>Corbin / Russwin</b> Large Format Interchangeable Core Mortise cylinder with Adams Rite Cam 1 1/2" long <b>OPTIONAL RIM PACK</b>	
	KM-LFH-YA	<b>YALE</b> Large Format Interchangeable Core Mortise cylinder with Adams Rite Cam 1 1/2" long <b>OPTIONAL RIM PACK</b>	
	RIM PACK	Mortise-Rim Combo component parts pack	

Other CAMS available. See HSK Accessories Page L109-L111

► For KEYING see page L115

## RESTRICTED KEY CONTROL REPLACEMENT CYLINDERS

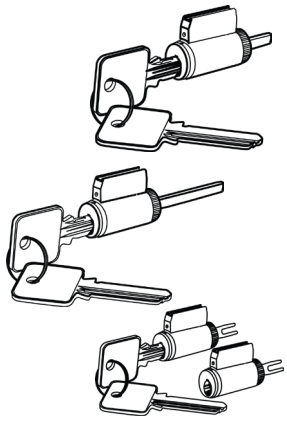
- Provide restricted key control by utilizing the HSK patented key control system
- Can be MASTER KEYED and / or KEYED ALIKE in combination with HSK HIGH SECURITY CYLINDERS
- Refer to HSK for keying

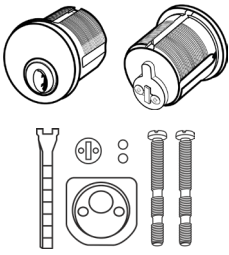
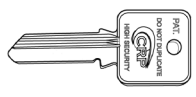
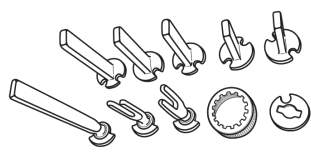
ILLUSTRATION	ITEM#	DESCRIPTION	FINISH	
<b>6-pin, 0-BITTED KEY-IN-KNOB / LEVER &amp; DEADBOLT REPLACEMENT CYLINDERS</b>				
	KKCRL-6	Key-In-Knob / Lever Replacement Cylinder 6-pin "0 Bitted" Includes 2 Standard keys / Lever Tailpiece (other tailpieces available)	US26D	
	KKCRLSD-6	Single Cylinder Deadbolt Replacement Cylinder 6-pin "0 Bitted" Includes 2 keys		
	KKCRLDD-6	Double Cylinder Deadbolt Replacement Cylinder (2 required) 6-pin "0 Bitted" Includes 2 keys		
<b>7-pin, UNCOMBINED REPLACEMENT CYLINDER / SMALL FORMAT IC CYLINDERS</b>				
	7PUCCRS	Uncombined Small Format Interchangeable Core Conventional SFIC, 7-pin Does not include keys		
<b>6-pin, 0-BITTED MORTISE / RIM CYLINDERS</b>				
	KMCRL-4	1 1/4" 6-pin "0 Bitted" Mortise Cylinder, comes with Adams Rite Cam. Other cams are available as HSK Includes 2 keys. <b>OPTIONAL RIM PACK</b>		
	RIM PACK	Mortise-Rim Combo component parts pack		
<b>KEY BLANKS</b>				
	KBCRL-6	Key Blanks for use with Full Size replacement cylinders 50 pieces per box		
	KBCRS-7	Key blanks for use with 7PUCCRS Small Format Interchangeable Cores. 50 pieces per box		
<b>TAILPIECE KIT</b>				
	KT-H-PK	<ul style="list-style-type: none"> <li>• KIKLCAP-01</li> <li>• KIKLCAP-02</li> <li>• LZTPSD-01</li> <li>• LZTPDD-01</li> <li>• LZTPDD-02</li> <li>• TPWASHER</li> <li>• KIKLZTP-01</li> <li>• KIKLZTP-02</li> <li>• KIKLZTP-03</li> <li>• KIKLZTP-04</li> <li>• KIKLZTP-05</li> <li>• KIKLZTP-06</li> </ul>	---	

► For KEYING see page L115

# CRP HSK HIGH SECURITY

## EXCLUSIVE PATENTED SIDE BAR KEYWAY





**MEETS**  
*The Buy American Act*

ILLUSTRATION	ITEM #	DESCRIPTION	FINISH	
	KIKL5 (Includes 2 Keys and all Tailpieces & Caps shown)	Universal 5-pin Grade 3 0-bitted <b>0B</b> Key-In-Knob / Lever & Deadbolt Cylinder Universal 5-pin Keyed Different <b>KD</b> Grade 3 Key-In-Knob / Lever & Deadbolt Cylinder	US26D, US3	
	KIKL6 (Includes 2 Keys and all Tailpieces & Caps shown)	UL-Listed Universal 6-pin 0-bitted <b>0B</b> Key-In-Knob / Lever & Deadbolt Cylinder UL-Listed Universal 6-pin Keyed Different <b>KD</b> Key-In-Knob / Lever & Deadbolt Cylinder		
	ULKIKL (Includes 2 Keys and all Tailpieces & Caps shown)	UL-Listed Universal 6-pin 0-bitted <b>0B</b> Key-In-Knob / Lever & Deadbolt Cylinder UL-Listed Universal 6-pin Keyed Different <b>KD</b> Key-In-Knob / Lever & Deadbolt Cylinder		
		LFIC6 (Includes 2 Keys)		6-pin 0-bitted <b>0B</b> <b>Schlage</b> Large Format Interchangeable Core 6-pin Keyed Different <b>KD</b> <b>Schlage</b> Large Format Interchangeable Core
		ULLFIC6 (Includes 2 Keys)		UL-Listed 6-pin "A" 0-bitted <b>0B</b> <b>Schlage</b> Large Format Interchangeable Core UL-Listed 6-pin "A" Keyed Different <b>KD</b> <b>Schlage</b> Large Format Interchangeable Core
		SFIC7 (Includes 2 Keys)		7-pin 0-bitted <b>0B</b> Small Format Interchangeable Core Cylinder 7-pin Keyed Different <b>KD</b> Small Format Interchangeable Core Cylinder
	ANSFIC7 (Includes 2 Keys)	ANSI / BHMA A156.30 certified 7-pin 0-bitted <b>0B</b> "A" Small Format Interchangeable Core Cylinder ANSI / BHMA A156.30 certified 7-pin 0-bitted <b>KD</b> "A" Small Format Interchangeable Core Cylinder		
	<p><b>Adams Rite Cam Standard</b></p> <p>RIM PACK</p>	MRC114 (Includes 2 Keys)	6-pin 1 1/4" 0-bitted <b>0B</b> Mortise-Rim Combination Cylinder Rim Pack Included 6-pin 1 1/4" 0-bitted <b>KD</b> Mortise-Rim Combination Cylinder Rim Pack Included	US26D
ULMRC114 (Includes 2 Keys)		UL-Listed 6-pin 1 1/4" "A" 0-bitted <b>0B</b> Mortise-Rim Combination Cylinder Rim Pack Included UL-Listed 6-pin 1 1/4" "A" Keyed Different <b>KD</b> Mortise-Rim Combination Cylinder Rim Pack Included		
		MRC118 (Includes 2 Keys)	6-pin 1 1/8" 0-bitted <b>0B</b> Mortise-Rim Combination Cylinder Rim Pack Included 6-pin 1 1/8" Keyed Different <b>KD</b> Mortise-Rim Combination Cylinder <b>(Rim Pack Included)</b>	
ULMRC118 (Includes 2 Keys)			UL-Listed 6-pin 1 1/8" "A" 0-bitted <b>0B</b> Mortise-Rim Combination Cylinder. <b>(Rim Pack Included)</b> UL-Listed 6-pin 1 1/8" "A" Keyed Different <b>KD</b> Mortise-Rim Combination <b>(Rim Pack Included)</b>	
		MRCLFIC-2-H	Mortise-Rim Combination Small Format IC Housing Adams Rite Cam Standard <b>(Rim Pack Included)</b>	
MRCSFIC-1-H		Mortise-Rim Combination Small Format IC Housing Adams Rite Cam Standard <b>(Rim Pack Included)</b>		
		KBL5	5-pin sidebar keyway Key Blank For Key-In-Knob / Lever, <b>Schlage</b> LFIC and Mortise / Rim Cylinders	
	KBL6	6-pin sidebar keyway Key Blank For Key-In-Knob / Lever, <b>Schlage</b> LFIC and Mortise / Rim Cylinders		
	KBLSF7	7-pin sidebar keyway Key Blank For <b>Small Format</b> Interchangeable Core		
	KCK6	<b>Schlage</b> LFIC, 6-pin Key-In-Knob / Lever and Mortise / Rim Cylinder sidebar keyway Control Key		

► For KEYING see page L115

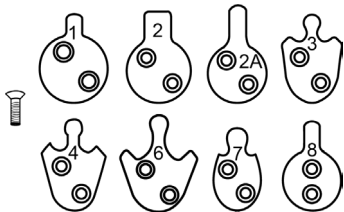
Standard Schlage Pinning kits are used for all cylinders except for Small Format, which uses Best pinning kits

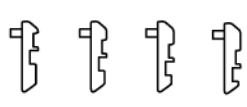
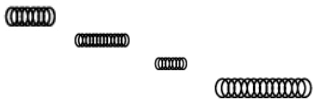
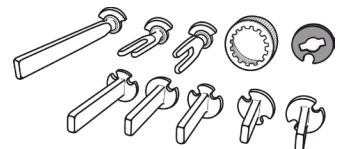
# CRP HSK HIGH SECURITY ACCESSORIES

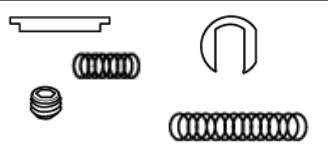
ILLUSTRATION	ITEM #	DESCRIPTION	PACK QUANTITY
<b>MORTISE-RIM CYLINDER COMBO and Small Format IC Housing COMPONENTS (NON-UL)</b>			
	CAMADAM-1	Adams Rite Cam	5
	CAMYALE-2	Yale Wide Cam	5
	CAMYALE-2A	Yale Standard Cam	5
	CAMRUSS-3	Corbin Russwin Cam	5
	CAMFLCN-4	Falcon Cam	5
	CAMCRP-6	Cal-Royal NM Series Mortise Lock Cam	5
	CAMSCHL-7	Schlage Cam	5
	CAMSGNT-8	Sargent Offset Cam	5
	CAMSCREW	Cam Screw	25
<b>MORTISE AND KIKL CYLINDER COMPONENTS (NON-UL)</b>			
	SIDEBAR-1	Side Bar	10
	SPIN1	Side Pin #1	10
	SPIN2	Side Pin #2	10
	SPIN3	Side Pin #3	10
	SPIN4	Side Pin #4	10
	SIDEBARSPRING	Spring for Side Bar	20
	KIKSPRING	Spring for Screw Cap	25
	MRTPINSPRING	Mortise Pin Spring	50
	KIKPINSPRING	Top Pin Spring	50
	LZTPSD-01	Lazy Tailpiece Long for Single Cylinder	10
	LZTPDD-01	Lazy Tailpiece Short for Double Cylinder Black	10
	LZTPDD-02	Lazy Tailpiece Short for Double Cylinder Gold	10
	TPWASHER	Black Washer to retain Long Tailpiece LZTPSD-01	10
	KIKLZTP-01	Lazy Tailpiece for Knob / Lever 5/8"	5
	KIKLZTP-02	Lazy Tailpiece for Knob / Lever 5/8"	5
	KIKLZTP-03	Lazy Tailpiece for Knob / Lever 7/8"	5
	KIKLZTP-04	Lazy Tailpiece for Knob / Lever 15/16"	5
KIKLZTP-05	Lazy Tailpiece for Knob / Lever 1 5/32"	5	
KIKLZTP-06	Lazy Tailpiece for Knob / Lever 1 5/32" Narrow Tip	5	
	ALLNSCRW-BLK	Allen Screw Black	25
	KIKPIN	Pin for Screw Cap	25
	KIKLCAP-01	KIKL Cap Long	10
	KIKLCAP-02	KIKL Cap Short	10
	MSHRMTPIN	Mushroom Top Pin	50
	RIM PACK	Mortise-Rim Combo component parts pack	1
<b>SMALL FORMAT INTERCHANGEABLE CORE (SFIC) CYLINDER HOUSING COMPONENTS</b>			
	SFICSPIN1	SFIC Side Pin #1	10
	SFICSPIN2	SFIC Side Pin #2	10
	SFICSPIN3	SFIC Side Pin #3	10
	SFICSIDEBAR	SFIC Side Bar	10
	SFICCCLIP	SFIC "C" Clip	25
	SFICSBSPR	SFIC Side Bar Spring	25
	SFICALLNSCRW	SFIC Allen Screw	25
	SFICSPR	SFIC Pin Spring	50

Standard Schlage Pinning kits are used for all cylinders except for Small Format, which uses Best pinning kits

**MEETS**  
*The Buy American Act*

# CRP HSK HIGH SECURITY ACCESSORIES

**MEETS**  
*The Buy American Act*

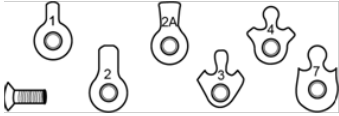
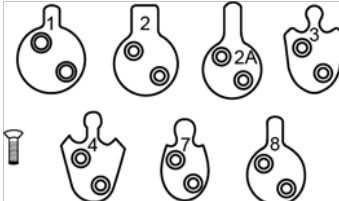
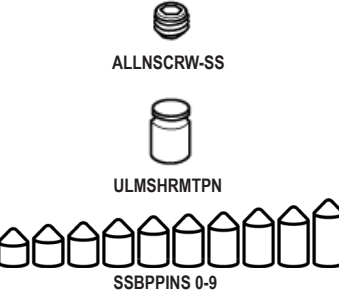
ILLUSTRATION	ITEM #	DESCRIPTION	PACK QUANTITY
<b>LARGE FORMAT INTERCHANGEABLE CORE (LFIC) CYLINDER HOUSING COMPONENTS</b>			
	LFCAMADAM-1	LFIC Adams Rite Cam	5
	LFCAMYALE-2	LFIC Yale Wide Cam	5
	LFCAMYALE-2A	LFIC Yale Standard Cam	5
	LFCAMRUSS-3	LFIC Corbin Russwin Cam	5
	LFCAMFLCN-4	LFIC Falcon Cam	5
	LFCAMSCHL-7	LFIC <b>Schlage</b> Cam	5
	LFCAMSCRW	LFIC Cam Screw	15
<b>MORTISE-RIM CYLINDER COMBO and Small Format IC Housing COMPONENTS (UL-LISTED)</b>			
	ULCAMADAM-1	UL-Listed Adams Rite Cam	5
	ULCAMYALE-2	UL-Listed Yale Wide Cam	5
	ULCAMYALE-2A	UL-Listed Yale Standard Cam	5
	ULCAMRUSS-3	UL-Listed Corbin Russwin Cam	5
	ULCAMFLCN-4	UL-Listed Falcon Cam	5
	ULCAMSCHL-7	UL-Listed <b>Schlage</b> Cam	5
	ULCAMSGNT-8	UL-Listed <b>Sargent</b> Offset Cam	5
	CAMSCREW	Cam Screw	25
<b>MORTISE AND KIKL CYLINDER COMPONENTS (UL-LISTED)</b>			
	ALLNSCRW-SS	Allen Screw Stainless Steel	25
	ULMSHRMTPIN	UL-Listed Mushroom Top Pin	50
	SSBPIN0	Stainless Steel Bottom Pin#0	12
	SSBPIN1	Stainless Steel Bottom Pin#1	12
	SSBPIN2	Stainless Steel Bottom Pin#2	12
	SSBPIN3	Stainless Steel Bottom Pin#3	12
	SSBPIN4	Stainless Steel Bottom Pin#4	12
	SSBPIN5	Stainless Steel Bottom Pin#5	12
	SSBPIN6	Stainless Steel Bottom Pin#6	12
	SSBPIN7	Stainless Steel Bottom Pin#7	12
	SSBPIN8	Stainless Steel Bottom Pin#8	12
	SSBPIN9	Stainless Steel Bottom Pin#9	12
	<b>OTHER ACCESSORIES</b>		
SEE NEXT PAGE	REGCARD	High Security Plastic Registration Card	10
	KITPARTS-1	Parts Kit for CRP High Security	1
	KITSTDPIN-2	Standard Pin Kit for CRP High Security	1
	KITULPIN-3	UL-Pinning Kit for CRP High Security	1
	KITULPIN-4	UL-Parts Kit for CRP High Security	1
	KITSFICPARTS-5	SFIC Parts	1
	KITCAMS-6	Small & Large Format Cams UL & Non-UL	1

Standard Schlage Pinning kits are used for all cylinders except for Small Format, which uses Best pinning kits



# CRP HSK HIGH SECURITY ACCESSORIES

**MEETS**  
*The Buy American Act*

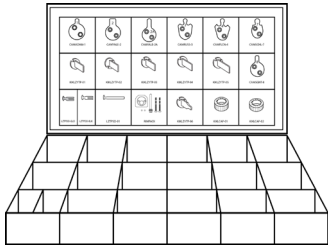
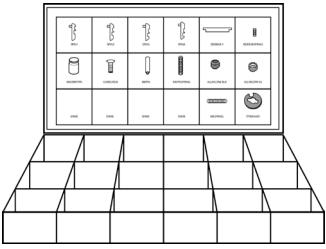
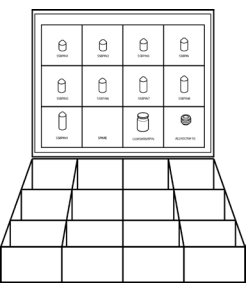
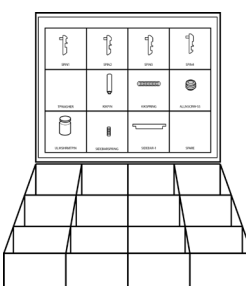
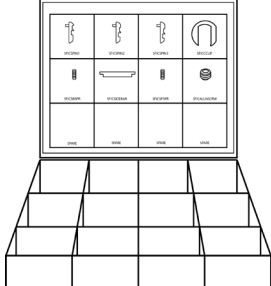
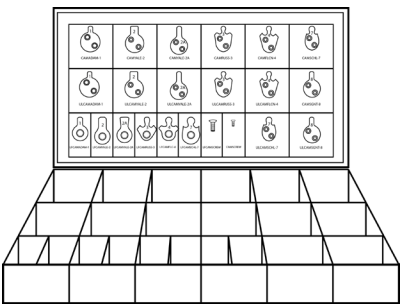
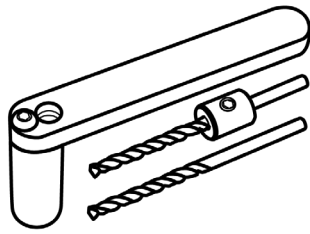
KITPARTS-1	KITSTDPIN-2	
 <p>CAMADAM-1 x 10, CAMYALE-2 x 10, CAMYALE-2A x 10, CAMRUSS-3 x 10, CAMFLCN-4 x 10, CAMSCHL-7 x 10, CAMSGNT-8 x 10, KIKLCAP-01 x 10, KIKLCAP-02 x 10, RIMPACK x 2, KIKLZTP-01 x 5, KIKLZTP-02 x 5, KIKLZTP-03 x 5, KIKLZTP-04 x 5, KIKLZTP-05 x 5, KIKLZTP-06 x 5, LZTPDD-BLK x 20, LZTPDD-GLD x 20, LZTPSD-01 x 10</p>	 <p>ALLNSCRW-SS x 25, ALLNSCRW-BLK x 25, KIKPINSRING x 100, KIKSPRING x 25, CAMSCREW x 25, SIDEBAR-1 x 10, MSHRMTPIN x 50, KIKPIN x 25, SPIN1 x 10, SPIN2 x 10, SPIN3 x 10, SPIN4 x 10, TPWASHER x 10, SIDEBARSRING x 20</p>	
KITULPIN-3	KITULPIN-4	KITSFICPARTS-5
 <p>SSBPIN0 x 24, SSBPIN1 x 24, SSBPIN2 x 24, SSBPIN3 x 24, SSBPIN4 x 24, SSBPIN5 x 24, SSBPIN6 x 24, SSBPIN7 x 24, SSBPIN8 x 24, SSBPIN9 x 24, ULSHRMTPIN x 50, ALLNSCRW-SS x 25</p>	 <p>SPIN1 x 20, SPIN2 x 20, SPIN3 x 20, SPIN4 x 20, TPWASHER x 20, KIKPIN x 25, KIKSPRING x 25, ALLNSCRW-SS x 25, ULSHRMTPIN x 100, SIDEBARSRING x 20, SIDEBAR-1 x 10</p>	 <p>SFICSPIN1 x 20, SFICSPIN2 x 20, SFICSPIN3 x 20, SFICCLIP x 25, SFICSPR x 50, SFICSIDEBAR x 10, SFICBSPR x 25, SFICALLNSCRW x 25</p>
KITCAMS-6	KZHSK COT	
 <p>LFCAMADAM-1 x 5, LFCAMFLCN-4 x 5, LFCAMRUSS-3 x 5, LFCAMSCHL-7 x 5, LFCAMSCRW x 30, LFCAMYALE-2 x 5, LFCAMYALE-2A x 5, MRTPINSRING x 50, ULCAMADAM-1 x 5, ULCAMFLCN-4 x 5, ULCAMRUSS-3 x 5, ULCAMSCHL-7 x 5, CAMSCREW x 25, ULCAMSGNT-8 x 5, ULCAMYALE-2 x 5, ULCAMYALE-2A x 5, CAMADAM-1 x 5, CAMYALE-2 x 5, CAMYALE-2A x 5, CAMRUSS-3 x 5, CAMFLCN-4 x 5, CAMSCHL-7 x 5, CAMSGNT-8 x 5</p>	 <p><b>DRIVE PIN CUT OFF TOOL</b> (Used for converting regular SFIC Housing for use with HSK SFIC Cylinders)</p>	

# CRP HSK HIGH SECURITY

**STOCK ITEM IN BOLD**  
**NON-STOCK FINISH AND DESIGNS AVAILABLE WITH FACTORY LEAD TIME**  
**AND SUBJECT TO MINIMUM ORDER**

## HSK HEAVY DUTY GRADE 1 DEADBOLTS

US26D

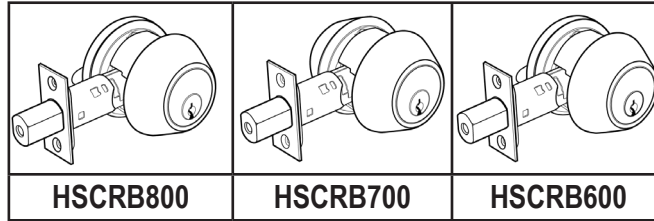

FUNCTION	ANSI	ITEM #	FINISH				PCS / MC
Grade 1, UL Listed, "HSK" Keyway <b>Single Cylinder Deadbolt</b>	E0152	HSCRB800	<b>US26D</b>	<b>US3, 15</b>	<b>US10B</b>	<b>US4, 5, 26</b>	20
Grade 1, UL Listed, "HSK" Keyway <b>Double Cylinder Deadbolt</b>	E0142	HSCRB700					
<b>Classroom</b> Deadbolt lock, Deadbolt thrown or retracted by key outside. Inside turn unit will retract bolt only. Bolt automatically deadlocks when fully thrown	F109	HSCRB600		<b>US3, 15</b>	<b>US10B</b>	<b>US4, 5, 26</b>	

## HSK HEAVY DUTY GRADE 2 DEADBOLTS

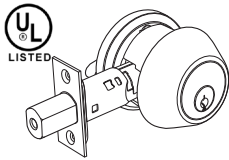
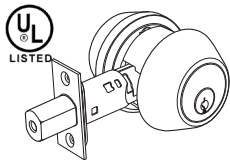
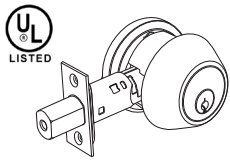
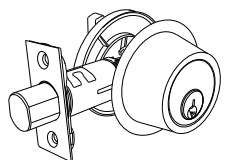
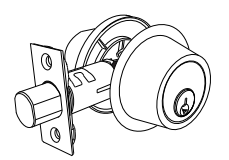
UL-LISTED			NON-UL	
				
<b>HSULT360 / HSCL600</b>	<b>HSULT362</b>	<b>HSULT700</b>	<b>HSCB160</b>	<b>HSCB162</b>

FUNCTION	ANSI	ITEM #	FINISH					PCS / MC		
Heavy Duty <b>Single Cylinder Deadbolt, UL Listed</b>	E0152	HSULT360	<b>US3</b>	<b>US26D</b>	<b>US10B</b>	<b>US4</b>	<b>US15</b>	<b>US26, US10</b>	<b>US5</b>	20
Heavy Duty <b>Double Cylinder Deadbolt, UL Listed</b>	E0142	HSULT362					<b>US15</b>		<b>US5</b>	
<b>Classroom</b> deadbolt lock <b>UL Listed</b>	E0172	HSCL600				<b>US4</b>	<b>US15</b>	<b>US26, US10</b>	<b>US5</b>	
One-Way Deadbolt Lock <b>UL Listed</b>	E1161	HSULT700	<b>US3</b>			<b>US4</b>	<b>US15</b>	<b>US26, US10</b>	<b>US5</b>	
Heavy Duty <b>Single Cylinder Deadbolt</b>	E0152	HSCB160	<b>US3, US26D</b>		<b>US4, US15, US26, US10, US5</b>				36	
Heavy Duty <b>Double Cylinder Deadbolt</b>	E0142	HSCB162								

► For KEYING see page L115

# CRP COMBI KEY SYSTEM

## EXCLUSIVE PATENTED COMBINATION KEYWAY

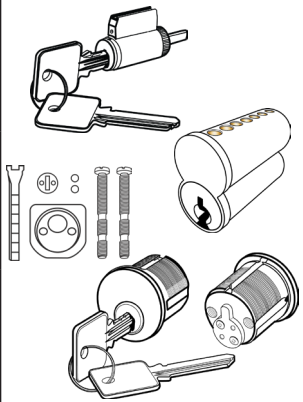
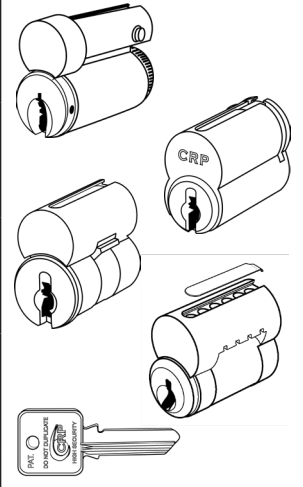
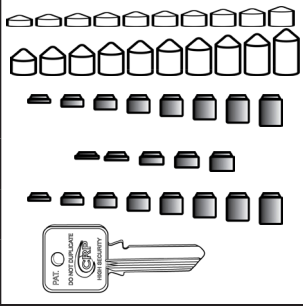
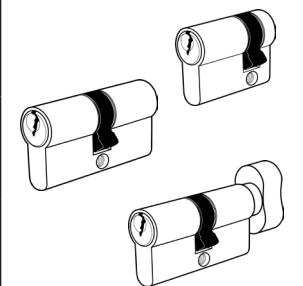
ILLUSTRATION	ITEM #	DESCRIPTION	FINISH
	<b>KK-COS-NS</b> (Includes 2 Keys and all Tailpieces & Caps shown)	Key-In-Knob / Lever Replacement Cylinder, 6-pin "0-bitted". Includes 2 keys / Lever Tailpiece. (other tailpieces available on request)	US26D
	<b>6PUC-COS</b> (NO keys included)	Uncombined Small Format Interchangeable Core Conventional SFIC, 6-pins. Does not include keys.	
	<b>KM-COS-4</b> (Includes 2 Keys and all Tailpieces & Caps shown)	1 1/4" 6-pin "0-bitted" Mortise Cylinder. Cylinder comes with Adams Rite Cam - other cams are available as HSK. Optional Rim Conversion Package available. See <b>page L107 (RIM PACK)</b> . Includes 2 keys.	
	<b>KL-COS-SC</b> (Includes 2 Keys)	<b>Schlage</b> Large Format, 6-pin "0-bitted". Includes 2 keys.	
	<b>KL-COS-YA</b> (Includes 2 Keys)	<b>Yale</b> Combi 6-pin Large Format IC control key for Schlage and Yale Large Format 6-pin uncombined. Does not include keys.	
	<b>KL-COS-SA</b> (Includes 2 Keys)	<b>Sargent</b> Combi 6-pin Large Format IC control key for Schlage and Yale Large Format 6-pin uncombined. Does not include keys.	
	<b>KL-COS-CR</b> (Includes 2 Keys)	<b>Corbin / Russwin</b> Large Format uncombined. Does not include keys.	
	<b>COSCK</b>	Combi Control Key for LFIC (Schlage and Yale cores).	
	<b>KP-I</b>	Combi SFIC (Best / Falcon A-2 Pins)	
	<b>KP-C2</b>	Combi Large Diameter Cylinders (A-2 Pinning)	
	<b>KP-I4</b>	Combi SFIC (Best / Falcon A-4 Pins)	
	<b>KP-C4</b>	Combi Large Diameter Cylinders (A-4 Pinning)	
	<b>KBCOS6</b>	Combi 6-pin key blank	
<b>EUROPEAN PROFILE CYLINDERS</b>			
	<b>KE-COS-S</b> (Includes 2 Keys)	1 3/4" (45mm) length, 6-pin standard, 0-bitted. 2 keys included. Half Cylinder	US26D
	<b>KE-COS-D</b> (Includes 2 Keys)	2 3/4" (70mm) length, 6-pin standard, 0-bitted. 2 keys included. Double Cylinder	
	<b>KE-COS-C</b> (Includes 2 Keys)	2 3/4" (70mm) length, 6-pin standard, 0-bitted. 2 keys included. Thumbturn Cylinder	

► For KEYING see page L115

## CRP COMBI PINNING KITS

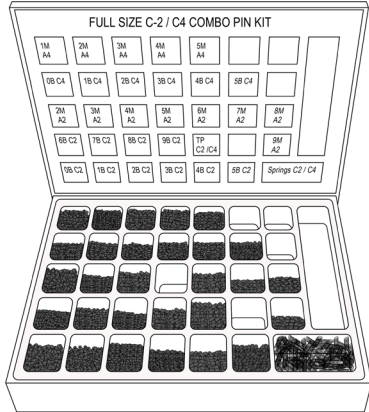

**COMBI C2 / C4 Full Size Pinning Kit**  
**DUAL COMBI A2 / A4 / C2 / C4**  
**Small Format & Full Size Pinning Kit**

### CRP PINNING KIT FOR COMBI CYLINDERS

<b>KP-I</b> <ul style="list-style-type: none"> <li>• SFIC pins for keying (same as BEST A2)</li> </ul>	<b>KP-I4</b> <ul style="list-style-type: none"> <li>• SFIC pins for keying (same as BEST A4)</li> </ul>	<b>KP-C2</b> <ul style="list-style-type: none"> <li>• Full size pins C2 large diameter cylinders</li> </ul>	<b>KP-C4</b> <ul style="list-style-type: none"> <li>• Full size pins C4 large format diameter cylinders</li> </ul>
<b>A2 SFIC PINS</b>	<b>A4 SFIC PINS</b>	<b>C2 FULL SIZE PINS</b>	<b>C4 FULL SIZE PINS</b>
<b>(2-19) Master Pins</b>  KP-I-2M    KP-I-8M    KP-I-14M KP-I-3M    KP-I-9M    KP-I-15M KP-I-4M    KP-I-10M    KP-I-16M KP-I-5M    KP-I-11M    KP-I-17M KP-I-6M    KP-I-12M    KP-I-18M KP-I-7M    KP-I-13M    KP-I-19M	<b>(1-11) Master Pins</b>  <ul style="list-style-type: none"> <li>• KP-I4-1M    • KP-I4-6M</li> <li>• KP-I4-2M    • KP-I4-8M</li> <li>• KP-I4-3M    • KP-I4-9M</li> <li>• KP-I4-4M    • KP-I4-10M</li> <li>• KP-I4-5M    • KP-I4-11M</li> </ul>	<b>(2-9) Master Pins</b>  <ul style="list-style-type: none"> <li>• KP-C2-2M    • KP-C2-6M</li> <li>• KP-C2-3M    • KP-C2-7M</li> <li>• KP-C2-4M    • KP-C2-8M</li> <li>• KP-C2-5M    • KP-C2-9M</li> </ul>	<b>(1-5) Master Pins</b>  <ul style="list-style-type: none"> <li>• KP-C4-1M</li> <li>• KP-C4-2M</li> <li>• KP-C4-3M</li> <li>• KP-C4-4M</li> <li>• KP-C4-5M</li> </ul>
 <b>(0-9) Bottom Pins</b> <ul style="list-style-type: none"> <li>• KP-I-0B    • KP-I-5B</li> <li>• KP-I-1B    • KP-I-6B</li> <li>• KP-I-2B    • KP-I-7B</li> <li>• KP-I-3B    • KP-I-8B</li> <li>• KP-I-4B    • KP-I-9B</li> </ul>	 <b>(0-5) Bottom Pins</b> <ul style="list-style-type: none"> <li>• KP-I4-0B    • KP-I4-3B</li> <li>• KP-I4-1B    • KP-I4-4B</li> <li>• KP-I4-2B    • KP-I4-5B</li> </ul>	 <b>(0-9) Bottom Pins</b> <ul style="list-style-type: none"> <li>• KP-C2-0B    • KP-C2-5B</li> <li>• KP-C2-1B    • KP-C2-6B</li> <li>• KP-C2-2B    • KP-C2-7B</li> <li>• KP-C2-3B    • KP-C2-8B</li> <li>• KP-C2-4B    • KP-C2-9B</li> </ul>	 <b>(0-5) Bottom Pins</b> <ul style="list-style-type: none"> <li>• KP-C4-0B    • KP-C4-3B</li> <li>• KP-C4-1B    • KP-C4-4B</li> <li>• KP-C4-2B    • KP-C4-5B</li> </ul>

### ACCESSORIES

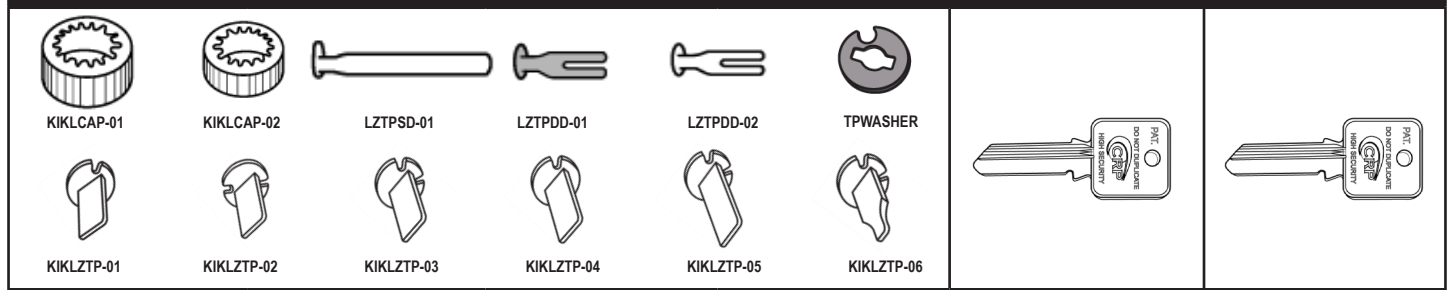

<b>KT-H-PK</b> <ul style="list-style-type: none"> <li>• KIKLCAP-01</li> <li>• KIKLCAP-02</li> <li>• LZTPSD-01</li> <li>• LZTPDD-01</li> <li>• LZTPDD-02</li> <li>• TPWASHER</li> </ul>	<div style="border: 1px solid black; padding: 5px; width: fit-content; margin: 0 auto;"> <b>SEE PAGE L109 FOR PRICING</b> </div>	<ul style="list-style-type: none"> <li>• KIKLZTP-01</li> <li>• KIKLZTP-02</li> <li>• KIKLZTP-03</li> <li>• KIKLZTP-04</li> <li>• KIKLZTP-05</li> <li>• KIKLZTP-06</li> </ul>	<b>KBCOS6</b> COMBI 6-pin key blank	<b>COSCK</b> COMBI 6-pin Large Format IC control key for Schlage and Yale
---	--	--	--	--

# KEYS & KEYING ...

## For Commercial Grade Locksets

**COMMERCIAL LOCKSETS, CONVENTIONAL CYLINDER KEYING  
( NOT INCLUDING RESIDENTIAL LOCKSETS )**

ITEM #	DESCRIPTION
KA	Key Alike / 0-bitted
MK	Master Keying (Including KA)
GMK	Grand Master Keying (Including KA & MK)
GGMK	Grand Grand Master Keying (Including KA & MK)
CMK	Construction Master Keying (Including KA & MK) N/A on HSK & COMBI
KM	Key Marking letters or numbers (AA1, AA2, ...) on key bow or cylinder core
DND	Do Not Duplicate
CMARK	Cylinder Marking
ECK	Extra Cut Key (2 keys standard per lock)
CECK	Extra Cut <b>Combi</b> Keys (2 keys standard per lock)
HECK	Extra Cut High Security Keys (2 keys standard per lock) <b>HSK</b>
CRSC15	Schalge "C" Key Blanks (5 pins)
CRSC16	Schalge "C" Key Blanks (6-pins)
CRKW1	Kwikset Key Blanks (5 pins)
<b>◆ KEYING KITS</b>	
KKC100	Keying Kit - "C" Keyway
KKWI200	Keying Kit - KWI Keyway

*2nd / 3rd Level  
keying systems  
is available*

**REQUEST  
QUOTE**

**See Keying Policies  
at our website  
regarding keying  
systems**

**🔑 COMMERCIAL LOCKSETS INTERCHANGEABLE CORE  
(LFIC, SFIC) KEYS & KEYING**

ICKA	Key Alike / 0-bitted
ICMK	Master Keying (Including KA)
ICGMK	Grand Master Keying (Including KA & MK)
ICGGMK	Grand Grand Master Keying (Including KA, MK & GMK)
IECK	SFIC Extra Cut Keys
CONKEY	Extra Cut Control Keys for Best Falcon and Arrow
CONKEY-1	Extra Cut Control Keys for Schlage "C"
CONKEY-2	Extra Cut Control Keys for Schlage "E"
CONKEY-3	Extra Cut Control Keys for Yale "GA"
KB-LF-GA	Control Key Blank for Yale "GA"
KB-LF-SC	Control Key Blank for Schlage "C"
KB-LF-SE	Control Key Blank for Schlage "E"

Two control keys are  
supplied with each Masterkey  
System at no charge

For HSK, CRL, CRS and COMBI Cylinders see HSK Service Manual on our website

## OTHER ACCESSORIES

ITEM #	DESCRIPTION
PDBFLS	Plastic Dust box for Full Lip Strike, 1" x 2 1/8", 7/16" Depth
PDB1214	Plastic Dust box for Residential Deadbolt Strike, 1 5/16" x 2 1/8", 1" Depth
PDB118234	Plastic Dust box for T-Strike, 1 1/16" x 2 3/4", 1" Depth
PDBTS	Plastic Dust box for Deadbolt T2STRK Strike, 1 1/16" x 2 3/4", 1/2" Depth
PDB478	Plastic Dust box for ASA Strike, 1 3/16" x 4 7/8", 15/16" Depth
LFA18	Latch front adapter to convert 1" plate to 1 1/8" wide door preparations ( Clear )

# RESIDENTIAL KEYING

KEYING	
ITEM #	DESCRIPTION
KARES	Key alike
MKRES	Master key (Including KA)
CMKRES	Builder construction master key (Including KA & MK)
GMKRES	Grand master key (Including KA, MK)