

TABLE OF CONTENTS

I. GRADE 1

MORTISE

ESCUTCHEON

| | |
|----------------------------|---------|
| NM Series..... | L5-L10 |
| WI Series (NM Series)..... | L11-L13 |
| WI Series (SC Series)..... | L18-L19 |

SECTIONAL

| | |
|----------------|---------|
| NM Series..... | L1-L4 |
| SC Series..... | L16-L17 |

DEADBOLT

| | |
|----------------|-----|
| NM Series..... | L14 |
| SC Series..... | L20 |

ACCESSORIES

| | |
|----------------|-----|
| NM Series..... | L15 |
| SC Series..... | L21 |

HOSPITAL

| | |
|----------------|-----|
| HL Series..... | L23 |
|----------------|-----|

ANTI - LIGATURE

| | |
|----------------|-----|
| LG Series..... | L24 |
|----------------|-----|

TUBULAR

| | |
|------------------|-----|
| HOSP Series..... | L26 |
|------------------|-----|

CYLINDRICAL

| | |
|-----------------------|-----|
| Genesys Series..... | L28 |
| Calypso Series..... | L36 |
| Omega GRB Series..... | L38 |

DEADBOLTS

| | |
|--------------------|-----|
| CRB800 Series..... | L67 |
|--------------------|-----|

II. GRADE 2

MECHANICAL

| | |
|-----------------------|-----|
| CRCODE200 Series..... | L44 |
|-----------------------|-----|

CYLINDRICAL

| | |
|-------------------------------|-----|
| Pioneer SL & CSL Series..... | L45 |
| Commander Com (Clutch)..... | L49 |
| Explorer XP & CXP Series..... | L50 |
| Challenger Series..... | L54 |
| Tuscany Series..... | L42 |
| Barrington BA Series..... | L58 |

INTERCONNECTED

| | |
|----------------------|-----|
| HIL Series List..... | L62 |
| JHIL Series..... | L63 |

DEADBOLT

| | |
|-------------------------------------|-----|
| T300 Series..... | L69 |
| T400 Series..... | L71 |
| CB160 Series..... | L73 |
| Standard Duty Deadbolts Series..... | L75 |
| Gate Latch Dead Latches Series..... | L77 |

III. GRADE 3

CYLINDRICAL

| | |
|----------------------|-----|
| Columbus Series..... | L61 |
| Epic Series..... | L64 |

III. GRADE 3

DEADBOLT

| | |
|---------------------------------------|-----|
| LSD Series..... | L79 |
| IND84 Indicator Deadbolts Series..... | L80 |
| Chelsie Series..... | L88 |

TUBULAR

| | |
|--------------------------|-----|
| Legacy Series..... | L98 |
| Clipper Series..... | L99 |
| Contemporary Series..... | L85 |
| Summit Series..... | L86 |
| Chelsie Series..... | L83 |
| Vanguard Series..... | L91 |
| Heritage Series..... | L97 |
| Ashley Series..... | L81 |
| Italia Series..... | L92 |

HANDLESETS

| | |
|---------------------|-----|
| Chelsie Series..... | L87 |
|---------------------|-----|

IV. KEYS & KEYING

REPLACEMENT CYLINDERS

| | |
|-----------------------------------|------|
| Key-in-Knob-Lever Cylinders..... | L102 |
| Rim Cylinders..... | L103 |
| Mortise Cylinders..... | L102 |
| Mortise and Rim Cylinders..... | L104 |
| Mortise Cylinder Accessories..... | L103 |
| Mortise Cylinder Cams..... | L103 |
| Small Format IC Cylinders..... | L105 |
| Large Format IC Cylinders..... | L106 |

RESTRICTED CYLINDERS

| | |
|------------------------------------|------|
| Key-in-Knob-Lever Cylinders..... | L107 |
| Small Format IC Cylinders..... | L107 |
| Mortise Cylinders..... | L107 |
| Single Cylinder Deadbolt Kits..... | L107 |
| Double Cylinder Deadbolt Kits..... | L107 |
| Mortise and Rim Cylinder Kits..... | L107 |
| | L107 |

HIGH SECURITY KEY (HSK) SYSTEM

| | |
|--|------|
| Key-in-Knob-Lever Cylinders..... | L108 |
| Mortise-Rim Combo Cylinder..... | L108 |
| Small Format Interchangeable Core Cylinders..... | L108 |
| Large Format Interchangeable Core Cylinders..... | L108 |
| IC Housing..... | L108 |
| Accessories..... | L109 |

CRP COMBI CYLINDER PROGRAM

| | |
|---|------|
| Key-in-Knob-Lever Cylinders..... | L113 |
| Small Format IC Cylinders..... | L113 |
| Mortise Cylinders..... | L113 |
| Large Format Interchangeable Cores..... | L113 |
| European Profile Cylinders..... | L113 |
| CRP Combi Pinning Kits..... | L114 |

COMMERCIAL KEYING..... L115

RESIDENTIAL KEYING..... L116

NM Series

HEAVY DUTY, GRADE 1 MORTISE LOCKSET

Optional Interchangeable Core Small Format (Best, Falcon and Arrow) or Large Format (Schlage)

| | | | | |
|---|---------------------------------|---|---|---|
| <p>3 HOUR FIRE RATED UL10C, UBC7-2-1997</p> | <p>LIFETIME WARRANTY</p> | <p>BHMA CERTIFIED Be Safe. Be Secure. Look for the Mark.</p> | <p>MEETS <i>The Buy American Act</i></p> | <p>HURRICANE APPROVED HARDWARE FLORIDA BUILDING CODE: FL13922-R1 ASTM E1886/E1996 ASTM E330 TAS 201, 202, 203 UL10B UL10C</p> |
|---|---------------------------------|---|---|---|

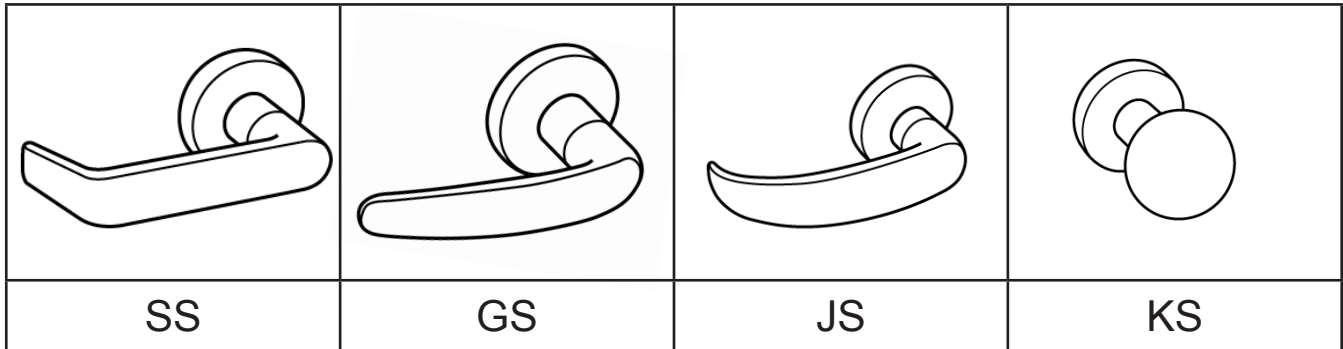

| SS, GS, JS, AND KS SECTIONAL TRIM ONLY | | | | | | | | |
|---|-------------|----------|-------|------|-------|-----|------|-----|
| FUNCTIONS | ANSI | FINISHES | | | | | | |
| | | US26D | US32D | US32 | US10B | US3 | US26 | US4 |
| ◀ Single cylinder without deadbolt | | | | | | | | |
| NM8050 - Office / Entrance | F04 | | | | | | | |
| NM8070 - Classroom | F05 | | | | | | | |
| NM8080 - Storeroom | F07 | | | | | | | |
| ◀ Single cylinder with deadbolt | | | | | | | | |
| NM8453 - Entrance | F20 | | | | | | | |
| NM8456 - Corridor | F13 | | | | | | | |
| NM8495 - Keyed Privacy w/ Indicator | ---- | | | | | | | |
| NM8465 - Closet / Storeroom | ---- | | | | | | | |
| NM8473 - Dormitory / Bedroom | F21 | | | | | | | |
| ◀ Double cylinder without deadbolt | | | | | | | | |
| NM8060 - Apartment Entrance | F09 | | | | | | | |
| NM8082 - Institution | F30 | | | | | | | |
| ◀ Double cylinder with deadbolt | | | | | | | | |
| NM8466 - Storeroom | F14 | | | | | | | |
| ◀ Other Functions | | | | | | | | |
| NM8040 - Privacy with Deadbolt | F02,F19,F22 | | | | | | | |
| NM8445 - Privacy with Indicator | ---- | | | | | | | |
| NM8010 - Passage | F01 | | | | | | | |
| NM8170 - Single Fixed Dummy | ---- | | | | | | | |
| NM8172 - Double Fixed Dummy | ---- | | | | | | | |

For pricing & availability inquiries contact your Local Distributor or click [here](#) for the list of our Sales Reps

Optional Interchangeable Cores. All keyed lock functions are available with Best, Falcon and Arrow, Schlage, Corbin / Russwin, Sargent, and Yale Large Format Interchangeable Cores.

HEAVY DUTY, GRADE 1 MORTISE LOCKSET

Optional Interchangeable Core Small Format (Best, Falcon and Arrow) or Large Format (Schlage)



LIFETIME WARRANTY

BHMA™
CERTIFIED
Be Safe. Be Secure. Look for the Mark.

MEETS
The Buy American Act

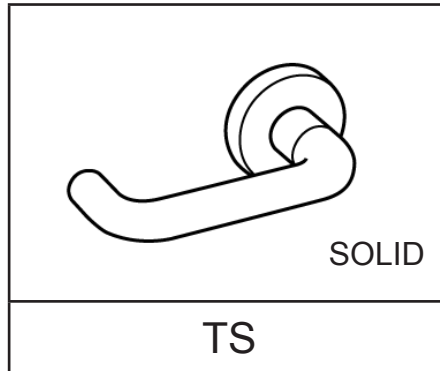
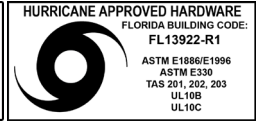

TS SECTIONAL TRIM ONLY

| FUNCTIONS | ANSI | FINISHES | | | | | | |
|---|-------------|---|-------|------|-------|-----|------|-----|
| | | US26D | US32D | US32 | US10B | US3 | US26 | US4 |
| ◀ Single cylinder without deadbolt | | For pricing & availability inquiries contact your Local Distributor or click here for the list of our Sales Reps | | | | | | |
| NM8050 - Office / Entrance | F04 | | | | | | | |
| NM8070 - Classroom | F05 | | | | | | | |
| NM8080 - Storeroom | F07 | | | | | | | |
| ◀ Single cylinder with deadbolt | | | | | | | | |
| NM8453 - Entrance | F20 | | | | | | | |
| NM8456 - Corridor | F13 | | | | | | | |
| NM8495 - Keyed Privacy w/ Indicator | ---- | | | | | | | |
| NM8465 - Closet / Storeroom | ---- | | | | | | | |
| NM8473 - Dormitory / Bedroom | F21 | | | | | | | |
| ◀ Double cylinder without deadbolt | | | | | | | | |
| NM8060 - Apartment Entrance | F09 | | | | | | | |
| NM8082 - Institution | F30 | | | | | | | |
| ◀ Double cylinder with deadbolt | | | | | | | | |
| NM8466 - Storeroom | F14 | | | | | | | |
| ◀ Other Functions | | | | | | | | |
| NM8040 - Privacy with Deadbolt | F02,F19,F22 | | | | | | | |
| NM8445 - Privacy with Indicator | ---- | | | | | | | |
| NM8010 - Passage | F01 | | | | | | | |
| NM8170 - Single Fixed Dummy | ---- | | | | | | | |
| NM8172 - Double Fixed Dummy | ---- | | | | | | | |

Optional Interchangeable Cores All keyed lock functions are available with **Best, Falcon and Arrow, Schlage, Corbin / Russwin, Sargent, and Yale Large Format Interchangeable Cores**

HEAVY DUTY, GRADE 1 MORTISE LOCKSET

Optional Interchangeable Core Small Format (Best, Falcon and Arrow) or Large Format (Schlage)



LIFETIME WARRANTY

BHMA CERTIFIED
Be Safe. Be Secure. Look for the Mark.

MEETS
The Buy American Act

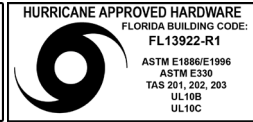

SECTIONAL TRIMS

| | | | |
|----------------------------------|----------------------------------|------------------|------------------|
| <p>(HOLLOW)</p> <p>CS</p> | <p>(HOLLOW)</p> <p>HS</p> | <p>VS</p> | <p>YS</p> |
| <p>FS</p> | <p>IS</p> | <p>DS</p> | <p>MS</p> |
| <p>QS</p> | <p>ZS</p> | <p>RS</p> | <p>PS</p> |
| <p>WS</p> | <p>XS</p> | | |

NM Series

| | | |
|--|--------------------------|---|
|  3 HOUR FIRE RATED UL10C, UBC7-2-1997 | LIFETIME WARRANTY | BHMA CERTIFIED Be Safe. Be Secure. Look for the Mark. |
| | | |

CS, HS, VS, YS, DS, FS, IS, MS, QS, RS, PS, WS, XS, ZS SECTIONAL TRIM ONLY

| FUNCTIONS | ANSI | FINISHES | | | | | | | |
|---|-------------|---|-------|------|-------|-----|------|-----|--|
| | | US26D | US32D | US32 | US10B | US3 | US26 | US4 | |
| ◀ Single cylinder without deadbolt | | For pricing & availability inquiries contact your Local Distributor or click here for the list of our Sales Reps | | | | | | | |
| NM8050 - Office / Entrance | F04 | | | | | | | | |
| NM8070 - Classroom | F05 | | | | | | | | |
| NM8080 - Storeroom | F07 | | | | | | | | |
| ◀ Single cylinder with deadbolt | | | | | | | | | |
| NM8453 - Entrance | F20 | | | | | | | | |
| NM8456 - Corridor | F13 | | | | | | | | |
| NM8495 - Keyed Privacy w/ Indicator | ---- | | | | | | | | |
| NM8465 - Closet / Storeroom | ---- | | | | | | | | |
| NM8473 - Dormitory / Bedroom | F21 | | | | | | | | |
| ◀ Double cylinder without deadbolt | | | | | | | | | |
| NM8060 - Apartment Entrance | F09 | | | | | | | | |
| NM8082 - Institution | F30 | | | | | | | | |
| ◀ Double cylinder with deadbolt | | | | | | | | | |
| NM8466 - Storeroom | F14 | | | | | | | | |
| ◀ Other Functions | | | | | | | | | |
| NM8040 - Privacy with Deadbolt | F02,F19,F22 | | | | | | | | |
| NM8445 - Privacy with Indicator | ---- | | | | | | | | |
| NM8010 - Passage | F01 | | | | | | | | |
| NM8170 - Single Fixed Dummy | ---- | | | | | | | | |
| NM8172 - Double Fixed Dummy | ---- | | | | | | | | |

 All keyed lock functions are available with **Best, Falcon and Arrow, Schlage, Corbin / Russwin, Sargent, and Yale Large Format Interchangeable Cores**

HEAVY DUTY, GRADE 1 MORTISE LOCKSET

**Optional Interchangeable Core Small Format (Best, Falcon and Arrow)
or Large Format (Schlage)**

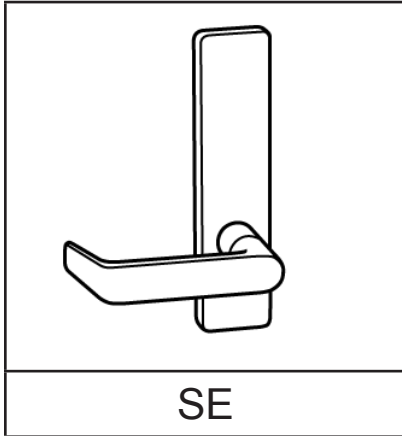

| SE ESCUTCHEON TRIM ONLY | | | | | | | | | | | | | |
|---|-------------|---|-------|-------|-----|------|-----|--|--|--|--|--|--|
| FUNCTIONS | ANSI | FINISHES | | | | | | | | | | | |
| | | US26D | US32D | US10B | US3 | US26 | US4 | | | | | | |
| ◀ Single cylinder without deadbolt | | | | | | | | | | | | | |
| NM8050 - Office / Entrance | F04 | <p>For pricing & availability inquiries contact your Local Distributor or click here for the list of our Sales Reps</p> | | | | | | | | | | | |
| NM8070 - Classroom | F05 | | | | | | | | | | | | |
| NM8080 - Storeroom | F07 | | | | | | | | | | | | |
| ◀ Single cylinder with deadbolt | | | | | | | | | | | | | |
| NM8453 - Entrance | F20 | | | | | | | | | | | | |
| NM8456 - Corridor | F13 | | | | | | | | | | | | |
| NM8495 - Keyed Privacy w/ Indicator | ---- | | | | | | | | | | | | |
| NM8465 - Closet / Storeroom | ---- | | | | | | | | | | | | |
| NM8473 - Dormitory / Bedroom | F21 | | | | | | | | | | | | |
| ◀ Double cylinder without deadbolt | | | | | | | | | | | | | |
| NM8060 - Apartment Entrance | F09 | | | | | | | | | | | | |
| NM8082 - Institution | F30 | | | | | | | | | | | | |
| ◀ Double cylinder with deadbolt | | | | | | | | | | | | | |
| NM8466 - Storeroom | F14 | | | | | | | | | | | | |
| ◀ Other Functions | | | | | | | | | | | | | |
| NM8040 - Privacy with Deadbolt | F02,F19,F22 | | | | | | | | | | | | |
| NM8445 - Privacy with Indicator | ---- | | | | | | | | | | | | |
| NM8010 - Passage | F01 | | | | | | | | | | | | |
| NM8170 - Single Fixed Dummy | ---- | | | | | | | | | | | | |
| NM8172 - Double Fixed Dummy | ---- | | | | | | | | | | | | |

Optional Interchangeable Cores All keyed lock functions are available with Best, Falcon and Arrow, Schlage, Corbin / Russwin, Sargent, and Yale Large Format Interchangeable Cores

HEAVY DUTY, GRADE 1 MORTISE LOCKSET

**Optional Interchangeable Core Small Format (Best, Falcon and Arrow)
or Large Format (Schlage)**

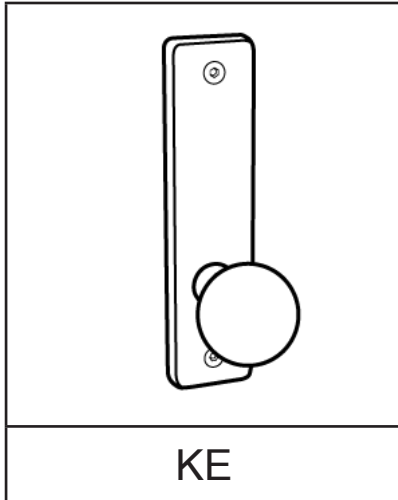

KE ESCUTCHEON TRIM ONLY

| FUNCTIONS | ANSI | FINISHES | | | | | |
|---|-------------|---|-------|-------|-----|------|-----|
| | | US26D | US32D | US10B | US3 | US26 | US4 |
| ◀ Single cylinder without deadbolt | | For pricing & availability inquiries contact your Local Distributor or click here for the list of our Sales Reps | | | | | |
| NM8050 - Office / Entrance | F04 | | | | | | |
| NM8070 - Classroom | F05 | | | | | | |
| NM8080 - Storeroom | F07 | | | | | | |
| ◀ Single cylinder with deadbolt | | | | | | | |
| NM8453 - Entrance | F20 | | | | | | |
| NM8456 - Corridor | F13 | | | | | | |
| NM8495 - Keyed Privacy w/ Indicator | ---- | | | | | | |
| NM8465 - Closet / Storeroom | ---- | | | | | | |
| NM8473 - Dormitory / Bedroom | F21 | | | | | | |
| ◀ Double cylinder without deadbolt | | | | | | | |
| NM8060 - Apartment Entrance | F09 | | | | | | |
| NM8082 - Institution | F30 | | | | | | |
| ◀ Double cylinder with deadbolt | | | | | | | |
| NM8466 - Storeroom | F14 | | | | | | |
| ◀ Other Functions | | | | | | | |
| NM8040 - Privacy with Deadbolt | F02,F19,F22 | | | | | | |
| NM8445 - Privacy with Indicator | ---- | | | | | | |
| NM8010 - Passage | F01 | | | | | | |
| NM8170 - Single Fixed Dummy | ---- | | | | | | |
| NM8172 - Double Fixed Dummy | ---- | | | | | | |

Optional Interchangeable Cores All keyed lock functions are available with **Best, Falcon and Arrow, Schlage, Corbin / Russwin, Sargent, and Yale Large Format Interchangeable Cores**

HEAVY DUTY, GRADE 1 MORTISE LOCKSET

**Optional Interchangeable Core Small Format (Best, Falcon and Arrow)
or Large Format (Schlage)**

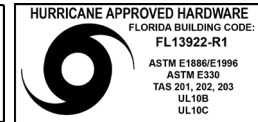
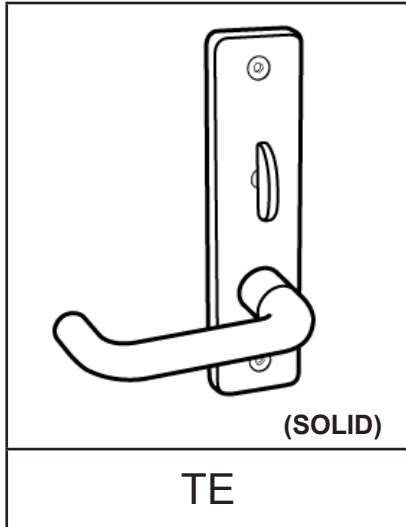

| TE ESCUTCHEON TRIM ONLY | | FINISHES | | | | | |
|---|-------------|---|-------|-------|-----|------|-----|
| FUNCTIONS | ANSI | US26D | US32D | US10B | US3 | US26 | US4 |
| | | <p>For pricing & availability inquiries contact your Local Distributor or click here for the list of our Sales Reps</p> | | | | | |
| ◀ Single cylinder without deadbolt | | | | | | | |
| NM8050 - Office / Entrance | F04 | | | | | | |
| NM8070 - Classroom | F05 | | | | | | |
| NM8080 - Storeroom | F07 | | | | | | |
| ◀ Single cylinder with deadbolt | | | | | | | |
| NM8453 - Entrance | F20 | | | | | | |
| NM8456 - Corridor | F13 | | | | | | |
| NM8495 - Keyed Privacy w/ Indicator | ---- | | | | | | |
| NM8465 - Closet / Storeroom | ---- | | | | | | |
| NM8473 - Dormitory / Bedroom | F21 | | | | | | |
| ◀ Double cylinder without deadbolt | | | | | | | |
| NM8060 - Apartment Entrance | F09 | | | | | | |
| NM8082 - Institution | F30 | | | | | | |
| ◀ Double cylinder with deadbolt | | | | | | | |
| NM8466 - Storeroom | F14 | | | | | | |
| ◀ Other Functions | | | | | | | |
| NM8040 - Privacy with Deadbolt | F02,F19,F22 | | | | | | |
| NM8445 - Privacy with Indicator | ---- | | | | | | |
| NM8010 - Passage | F01 | | | | | | |
| NM8170 - Single Fixed Dummy | ---- | | | | | | |
| NM8172 - Double Fixed Dummy | ---- | | | | | | |

Optional Interchangeable Cores All keyed lock functions are available with Best, Falcon and Arrow, Schlage, Corbin / Russwin, Sargent, and Yale Large Format Interchangeable Cores

HEAVY DUTY, GRADE 1 MORTISE LOCKSET

Optional Interchangeable Core Small Format (Best, Falcon and Arrow) or Large Format (Schlage)

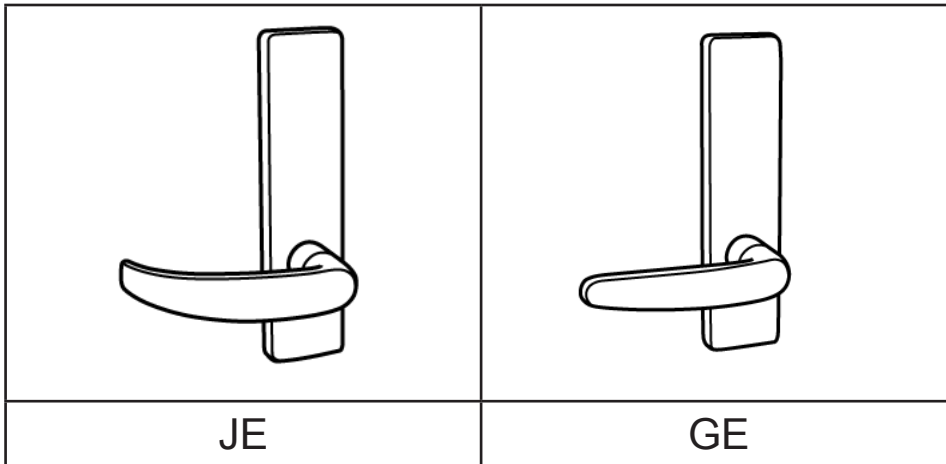
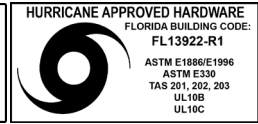

JE AND GE ESCUTCHEON TRIM ONLY

| FUNCTIONS | ANSI | FINISHES | | | | | |
|---|-------------|---|-------|-------|-----|------|-----|
| | | US26D | US32D | US10B | US3 | US26 | US4 |
| ◀ Single cylinder without deadbolt | | For pricing & availability inquiries contact your Local Distributor or click here for the list of our Sales Reps | | | | | |
| NM8050 - Office / Entrance | F04 | | | | | | |
| NM8070 - Classroom | F05 | | | | | | |
| NM8080 - Storeroom | F07 | | | | | | |
| ◀ Single cylinder with deadbolt | | | | | | | |
| NM8453 - Entrance | F20 | | | | | | |
| NM8456 - Corridor | F13 | | | | | | |
| NM8495 - Keyed Privacy w/ Indicator | ---- | | | | | | |
| NM8465 - Closet / Storeroom | ---- | | | | | | |
| NM8473 - Dormitory / Bedroom | F21 | | | | | | |
| ◀ Double cylinder without deadbolt | | | | | | | |
| NM8060 - Apartment Entrance | F09 | | | | | | |
| NM8082 - Institution | F30 | | | | | | |
| ◀ Double cylinder with deadbolt | | | | | | | |
| NM8466 - Storeroom | F14 | | | | | | |
| ◀ Other Functions | | | | | | | |
| NM8040 - Privacy with Deadbolt | F02,F19,F22 | | | | | | |
| NM8445 - Privacy with Indicator | ---- | | | | | | |
| NM8010 - Passage | F01 | | | | | | |
| NM8170 - Single Fixed Dummy | ---- | | | | | | |
| NM8172 - Double Fixed Dummy | ---- | | | | | | |

Optional Interchangeable Core. All keyed lock functions are available with Best, Falcon and Arrow, Schlage, Corbin / Russwin, Sargent, and Yale Large Format Interchangeable Core.

NM Series

HEAVY DUTY, GRADE 1 MORTISE LOCKSET

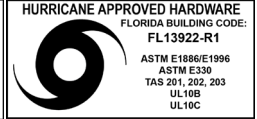

Optional Interchangeable Core Small Format (Best, Falcon and Arrow) or Large Format (Schlage)

LIFETIME WARRANTY

BHMA
CERTIFIED
Be Safe. Be Secure. Look for the Mark.

MEETS
The Buy American Act

ESCUTCHEON TRIMS

| | | | |
|---------------------------|---------------------------|---------------|---------------|
| (HOLLOW) CE | (HOLLOW) HE | VE | YE |
| FE | IE | DE | ME |
| QE | ZE | RE | PE |
| WE | XE | | |

HEAVY DUTY, GRADE 1 MORTISE LOCKSET

Optional Interchangeable Core Small Format (Best, Falcon and Arrow) or Large Format (Schlage)

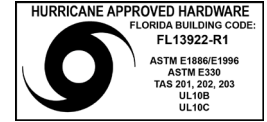

LIFETIME WARRANTY

BHMA CERTIFIED
Be Safe. Be Secure. Look for the Mark.

MEETS
The Buy American Act

CE, HE, VE, YE, FE, IE, DE, ME, QE, ZE, RE, PE, WE, XE ESCUTCHEON TRIM ONLY

| FUNCTIONS | ANSI | FINISHES | | | | | |
|---|-------------|---|-------|-------|-----|------|-----|
| | | US26D | US32D | US10B | US3 | US26 | US4 |
| ◀ Single cylinder without deadbolt | | For pricing & availability inquiries contact your Local Distributor or click here for the list of our Sales Reps | | | | | |
| NM8050 - Office / Entrance | F04 | | | | | | |
| NM8070 - Classroom | F05 | | | | | | |
| NM8080 - Storeroom | F07 | | | | | | |
| ◀ Single cylinder with deadbolt | | | | | | | |
| NM8453 - Entrance | F20 | | | | | | |
| NM8456 - Corridor | F13 | | | | | | |
| NM8495 - Keyed Privacy w/ Indicator | ---- | | | | | | |
| NM8465 - Closet / Storeroom | ---- | | | | | | |
| NM8473 - Dormitory / Bedroom | F21 | | | | | | |
| ◀ Double cylinder without deadbolt | | | | | | | |
| NM8060 - Apartment Entrance | F09 | | | | | | |
| NM8082 - Institution | F30 | | | | | | |
| ◀ Double cylinder with deadbolt | | | | | | | |
| NM8466 - Storeroom | F14 | | | | | | |
| ◀ Other Functions | | | | | | | |
| NM8040 - Privacy with Deadbolt | F02,F19,F22 | | | | | | |
| NM8445 - Privacy with Indicator | ---- | | | | | | |
| NM8010 - Passage | F01 | | | | | | |
| NM8170 - Single Fixed Dummy | ---- | | | | | | |
| NM8172 - Double Fixed Dummy | ---- | | | | | | |

Optional Interchangeable Cores All keyed lock functions are available with Best, Falcon and Arrow, Schlage, Corbin / Russwin, Sargent, and Yale Large Format Interchangeable Cores

WI Series

HEAVY DUTY, GRADE 1 WIDE ESCUTCHEON MORTISE LOCKSET

Optional Interchangeable Core Small Format (Best, Falcon and Arrow) or Large Format (Schlage)

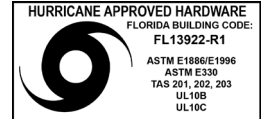

LIFETIME WARRANTY

BHMA
CERTIFIED
Be Safe. Be Secure. Look for the Mark.

MEETS
The Buy American Act

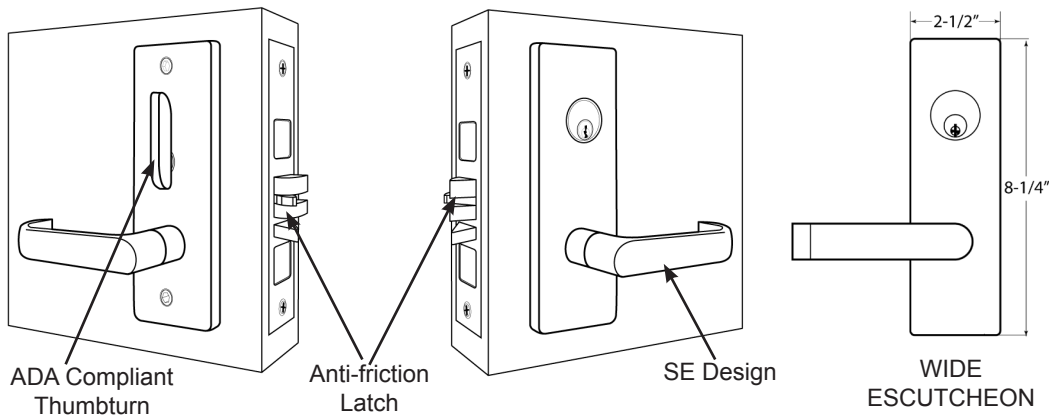

| WIDE ESCUTCHEON SE TRIM ONLY | | | | | | | | | |
|---|-------------|--|-------|-----|------|-----|--|--|--|
| FUNCTIONS | ANSI | FINISHES | | | | | | | |
| | | US26D | US10B | US3 | US26 | US4 | | | |
| ◀ Single cylinder without deadbolt | | | | | | | | | |
| WI8050 - Office / Entrance | F04 | For pricing & availability inquiries contact your Local Distributor or click here for the list of our Sales Reps | | | | | | | |
| WI8070 - Classroom | F05 | | | | | | | | |
| WI8080 - Storeroom | F07 | | | | | | | | |
| ◀ Single cylinder with deadbolt | | | | | | | | | |
| WI8453 - Entrance | F20 | | | | | | | | |
| WI8456 - Corridor | F13 | | | | | | | | |
| WI8495 - Keyed Privacy w/ Indicator | ---- | | | | | | | | |
| WI8465 - Closet / Storeroom | ---- | | | | | | | | |
| WI8473 - Dormitory / Bedroom | F21 | | | | | | | | |
| ◀ Double cylinder without deadbolt | | | | | | | | | |
| WI8060 - Apartment Entrance | F09 | | | | | | | | |
| WI8082 - Institution | F30 | | | | | | | | |
| ◀ Double cylinder with deadbolt | | | | | | | | | |
| WI8466 - Storeroom | F14 | | | | | | | | |
| ◀ Other Functions | | | | | | | | | |
| WI8040 - Privacy with Deadbolt | F02,F19,F22 | | | | | | | | |
| WI8445 - Privacy with Indicator | ---- | | | | | | | | |
| WI8010 - Passage | F01 | | | | | | | | |
| WI8170 - Single Fixed Dummy | ---- | | | | | | | | |

Optional Interchangeable Cores All keyed lock functions are available with Best, Falcon and Arrow, Schlage, Corbin / Russwin, Sargent, and Yale Large Format Interchangeable Cores

WI Series

HEAVY DUTY, GRADE 1 WIDE ESCUTCHEON MORTISE LOCKSET

Optional Interchangeable Core Small Format (Best, Falcon and Arrow) or Large Format (Schlage)



LIFETIME WARRANTY

BHMA CERTIFIED
Be Safe. Be Secure. Look for the Mark.

MEETS
The Buy American Act

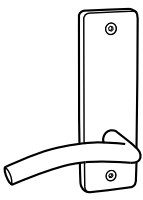
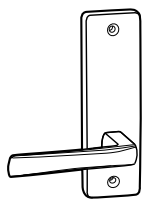
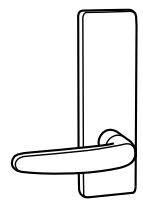
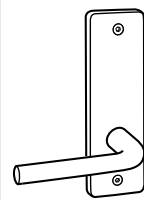
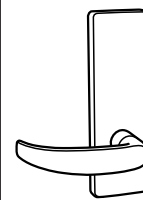
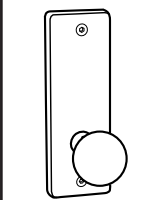
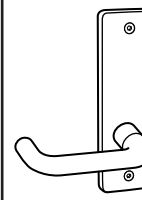
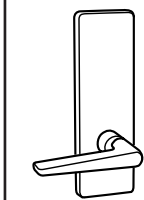
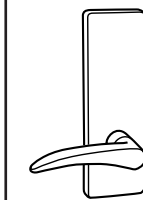

| | | | | | | | | |
|--|---|---|---|---|--|---|---|---|
|  |  |  |  |  |  |  |  |  |
| CE* | DE* | GE | HE* | JE | KE | TE* | VE | YE |

WIDE ESCUTCHEON CE, DE, GE, HE, JE, KE, TE, VE, YE TRIM ONLY

| FUNCTIONS | ANSI | FINISHES | | | | |
|---|-------------|----------|--------|------|-------|--|
| | | US26D | *US32D | US32 | US10B | US3 |
| ◀ Single cylinder without deadbolt | | | | | | For pricing & availability inquiries contact your Local Distributor or click here for the list of our Sales Reps |
| WI8050 - Office / Entrance | F04 | | | | | |
| WI8070 - Classroom | F05 | | | | | |
| WI8080 - Storeroom | F07 | | | | | |
| ◀ Single cylinder with deadbolt | | | | | | |
| WI8453 - Entrance | F20 | | | | | |
| WI8456 - Corridor | F13 | | | | | |
| WI8495 - Keyed Privacy w/ Indicator | ---- | | | | | |
| WI8465 - Closet / Storeroom | ---- | | | | | |
| WI8473 - Dormitory / Bedroom | F21 | | | | | |
| ◀ Double cylinder without deadbolt | | | | | | |
| WI8060 - Apartment Entrance | F09 | | | | | |
| WI8082 - Institution | F30 | | | | | |
| ◀ Double cylinder with deadbolt | | | | | | |
| WI8466 - Storeroom | F14 | | | | | |
| ◀ Other Functions | | | | | | |
| WI8040 - Privacy with Deadbolt | F02,F19,F22 | | | | | |
| WI8445 - Privacy with Indicator | ---- | | | | | |
| WI8010 - Passage | F01 | | | | | |
| WI8170 - Single Fixed Dummy | ---- | | | | | |

Optional Interchangeable Cores All keyed lock functions are available with Best, Falcon and Arrow, Schlage, Corbin / Russwin, Sargent, and Yale Large Format Interchangeable Cores

WI Series

HEAVY DUTY, GRADE 1 WIDE ESCUTCHEON MORTISE LOCKSET

Optional Interchangeable Core Small Format (Best, Falcon and Arrow) or Large Format (Schlage)

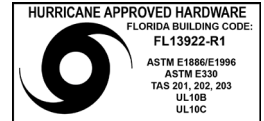

LIFETIME WARRANTY

BHMA CERTIFIED
Be Safe. Be Secure. Look for the Mark.

MEETS
The Buy American Act

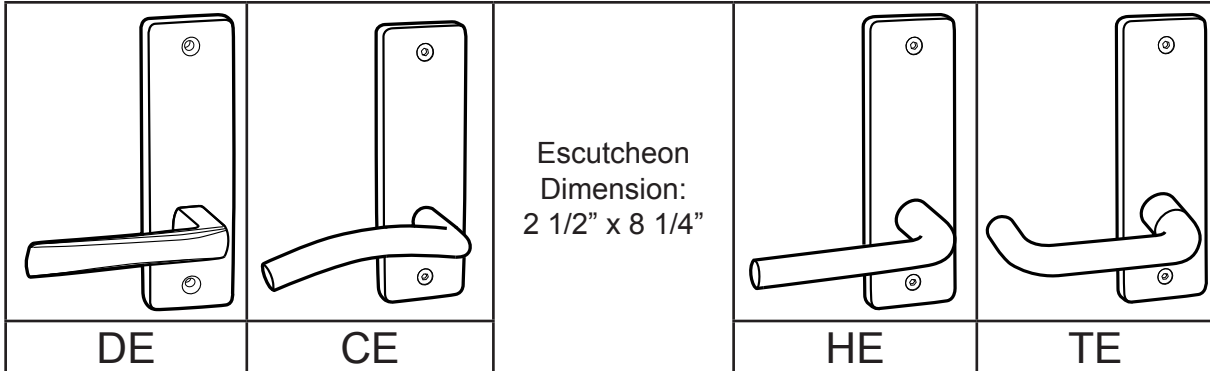

WIDE ESCUTCHEON WDE, WCE, WHE, WTE TRIM ONLY

| FUNCTIONS | ANSI | FINISH | |
|---|-------------|--|--|
| | | US32D | |
| ◀ Single cylinder without deadbolt | | | |
| WI8050 - Office / Entrance | F04 | For pricing & availability inquiries contact your Local Distributor or click here for the list of our Sales Reps | |
| WI8070 - Classroom | F05 | | |
| WI8080 - Storeroom | F07 | | |
| ◀ Single cylinder with deadbolt | | | |
| WI8453 - Entrance | F20 | | |
| WI8456 - Corridor | F13 | | |
| WI8495 - Keyed Privacy w/ Indicator | ---- | | |
| WI8465 - Closet / Storeroom | ---- | | |
| WI8473 - Dormitory / Bedroom | F21 | | |
| ◀ Double cylinder without deadbolt | | | |
| WI8060 - Apartment Entrance | F09 | | |
| WI8082 - Institution | F30 | | |
| ◀ Double cylinder with deadbolt | | | |
| WI8466 - Storeroom | F14 | | |
| ◀ Other Functions | | | |
| WI8040 - Privacy with Deadbolt | F02,F19,F22 | | |
| WI8445 - Privacy with Indicator | ---- | | |
| WI8010 - Passage | F01 | | |
| WI8170 - Single Fixed Dummy | ---- | | |

Optional Interchangeable Cores All keyed lock functions are available with Best, Falcon and Arrow, Schlage, Corbin / Russwin, Sargent, and Yale Large Format Interchangeable Cores

M & SM Series

HEAVY DUTY, GRADE 1 MORTISE DEADBOLTS

Optional Interchangeable Core Small Format (Best, Falcon and Arrow) or Large Format (Schlage)

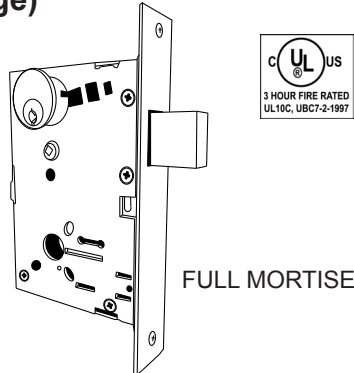
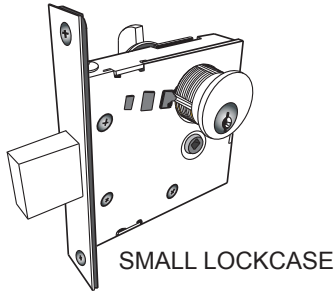

| MODEL# | ANSI | US26D, 32D | US10B, 3, 26, 4 | FUNCTIONS | MODEL# | ANSI | US26D, 32D | US10B, 3, 26, 4 |
|------------|--------|--|-----------------|---|-----------|------|------------|--|
| SM4608 | E06071 | For pricing & availability inquiries contact your Local Distributor or click here for the list of our Sales Reps | | Cylinder and Thumbturn Deadbolt thrown or retracted by key outside or thumbturn inside. | M8460 | F17 | | For pricing & availability inquiries contact your Local Distributor or click here for the list of our Sales Reps |
| SM4628 | E06061 | | | Double Cylinder Deadbolt operated by key on either side. | M8462 | F16 | | |
| SM4638 | E06091 | | | Classroom Lock Deadbolt thrown or retracted by key from outside. Inside cylinder turn retracts deadbolt but cannot project it. | M8463 | F29 | | |
| SM4648 | E06081 | | | Cylinder Lock Deadbolt thrown or retracted by key from one side. No trim on opposite side. | M8464 | F18 | | |
| SM4808 | --- | | | Door Bolt Deadbolt thrown or retracted by thumbturn from one side. No trim on opposite side. | M8480 | --- | | |
| SM4968 | --- | | | Deadbolt with "OCCUPIED" indicator Deadbolt thrown or retracted by key outside or thumbturn inside. "OCC" plate is displayed when deadbolt is thrown. | M8496 | --- | | |

Optional Interchangeable Cores All keyed lock functions are available with **Best, Falcon and Arrow, Schlage, Corbin / Russwin, Sargent, and Yale Large Format Interchangeable Cores**

NM Series

HEAVY DUTY, GRADE 1 MORTISE LOCKSET

► **PACKAGING INCLUDES**

- 6 locks per case
- UL listed single point latch
- Standard "C", 6-pin cylinder
- Non-handed strike

► **KEYWAYS**

6-pin solid brass "C" keyway standard. Optional: Schlage E, Schlage C-K, Russwin D1-2-3-4, Corbin 59 / 60, Arrow A, Corbin-Russwin L4, Sargent LA-LB-LC, Falcon / Weiser E, Yale 8, Yale GA and Kwikset. Can also accept Medeco, Assa, Kaba and **Cal-Royal HSK** High Security Cylinders.

When using 1 1/8" length Mortise cylinder for sectional trim and 1 1/4" length Mortise cylinder for Escutcheon **MUST USE CLOVER CAM** supplied by Cal-Royal.

► **IC CORE**

For **Best, Falcon and Arrow** Interchangeable Core prefix "IC" before Part #.
(Mortise housing Part # ICH961387)

For **Schlage** Large Format Interchangeable Core prefix "ICSC",
For **Corbin / Russwin** Large Format Interchangeable Core prefix "ICCR",
For **Sargent** Large Format Interchangeable Core prefix "ICSA",
For **Yale** Large Format Interchangeable Core prefix "ICYA"
before Part #.
(Mortise housing Part # 7000ICMC)

Due to easy reversibility of NM Series, if handing is not available at time of shipment opposite hand will be shipped

► **QUICKMARK TEMPLATE**

Available heavy duty steel template for fast and easy installation. Reduces installation time. Eliminates using paper templates.
Part # MTCAL

► **OPTIONAL ADA THUMBTURN**

Prefix "ADA" before Mortise lock ITEM#
Use Part # "ADATHUMB"
when ordering separately.

► FOR 2" up to 2 1/4" Thick door

Order kit:
SSMKIT214 - for sectional trim
SEMKIT214 - for escutcheon trim

► **TACTILE**

Tactile: Part # TAC

► **ELECTRIFIED**

Available on Storeroom Only
• Electrified Part # ELEC (Specify Options)

FEATURES:

- UL and CSFM Listings
- Continuous duty solenoids for cooler operation during "continuously on" applications
- Standard plug-in rectifier allows for an AC or DC power source
- Low current draw
- Numerous switch options
- 3 year "No Hassle" warranty

OPTIONS:

- Voltage requirement -12 VAC / DC or 24 VAC / DC
- Amperage - 700mA @ 12V or 350mA @ 24V
- Function - available "Fail Safe" (FS) or "Fail Secure" (FSE)

- **REX** - Request to Exit
Available on NM8080 and NM8453 Functions

► **LEAD LINING**

- Part # LEAD

► **ANTI MICROBIAL COATING**

Available on US26D and US32D finishes.
Prefix "ANTB" before Part #.

ADA THUMBTURN

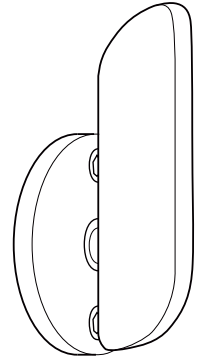

► **HOW TO ORDER**

1. Office Function
2. SS Trim Sectional
3. Satin Chrome
4. Right Handed

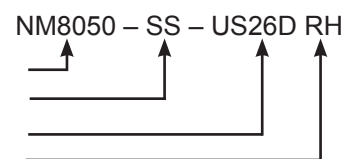

SC Series

HEAVY DUTY, GRADE 1 MORTISE LOCKSET

•• Optional Interchangeable Core Small Format (Best, Falcon and Arrow)
or Large Format (Schlage)

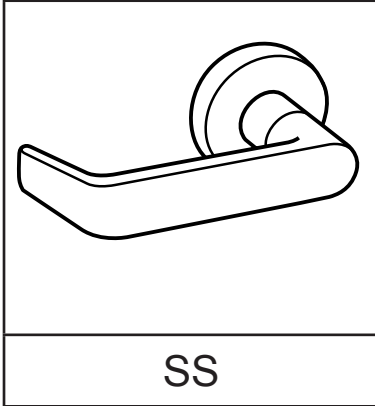

SS SECTIONAL TRIM ONLY

| FUNCTIONS | ANSI | FINISHES | | | | | | |
|--|------|---|-------|------|-------|-----|------|-----|
| | | US26D | US32D | US32 | US10B | US3 | US26 | US4 |
| ◀ Single cylinder without deadbolt | | For pricing & availability inquiries contact your Local Distributor or click here for the list of our Sales Reps | | | | | | |
| SC8050 - Office / Entrance | F04 | | | | | | | |
| SC8070 - Classroom | F05 | | | | | | | |
| SC8080 - Storeroom | F07 | | | | | | | |
| ◀ Single cylinder with deadbolt | | | | | | | | |
| SC8453 - Entrance | F20 | | | | | | | |
| SC8456 - Corridor | F13 | | | | | | | |
| SC8465 - Closet / Storeroom w/ DB | F65 | | | | | | | |
| SC8495 - Privacy w/ Indicator | ---- | | | | | | | |
| SC8486 - Faculty Restroom w/ Indicator | | | | | | | | |
| SC8473 - Dormitory / Bedroom | F21 | | | | | | | |
| ◀ Double cylinder without deadbolt | | | | | | | | |
| SC8060 - Apartment Entrance | F09 | | | | | | | |
| SC8082 - Institution | F30 | | | | | | | |
| SC8466 - Store Door Lock | F14 | | | | | | | |
| SC8071 - Classroom Security Lock | F32 | | | | | | | |
| SC8457 - Classroom Security w/ DB | F33 | | | | | | | |
| ◀ Other Functions | | | | | | | | |
| SC8458 - Classroom w/ DB & Aux Latch | F34 | | | | | | | |
| SC8040 - Privacy with Deadbolt | F19 | | | | | | | |
| SC8445 - Privacy w/ Deadbolt, Coin turn & Indicator | --- | | | | | | | |
| SC8170 - Single Fixed Dummy | ---- | | | | | | | |
| SC8010 - Passage | F01 | | | | | | | |

•• All keyed lock functions are available with Best, Falcon and Arrow, Schlage, Corbin / Russwin, Sargent, and Yale Large Format Interchangeable Cores

SC Series

HEAVY DUTY, GRADE 1 MORTISE LOCKSET

Optional Interchangeable Core Small Format (Best, Falcon and Arrow) or Large Format (Schlage)

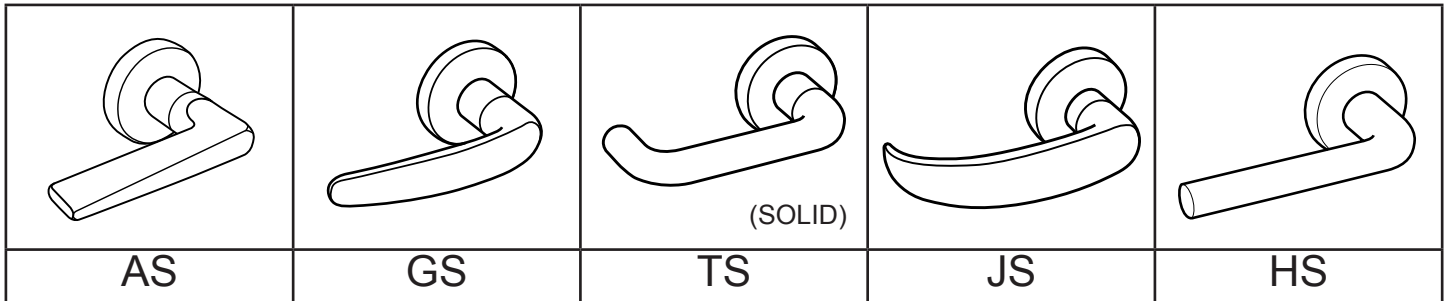

| AS, GS, TS, JS, HS SERIES SECTIONAL TRIM ONLY | | | | | | | | |
|---|------|----------|--------|--------|--------|--------|--------|--------|
| FUNCTIONS | ANSI | FINISHES | | | | | | |
| | | US26D | US32D | US32 | US10B | US3 | US26 | US4 |
| ◀ Single cylinder without deadbolt | | | | | | | | |
| SC8050 - Office / Entrance | F04 | | | | | | | |
| SC8070 - Classroom | F05 | | | | | | | |
| SC8080 - Storeroom | F07 | | | | | | | |
| ◀ Single cylinder with deadbolt | | | | | | | | |
| SC8453 - Entrance | F20 | | | | | | | |
| SC8456 - Corridor | F13 | | | | | | | |
| SC8465 - Closet / Storeroom w/ DB | F65 | | | | | | | |
| SC8495 - Privacy w/ Indicator | | | | | | | | |
| SC8486 - Faculty Restroom w/ Indicator | ---- | | | | | | | |
| SC8473 - Dormitory / Bedroom | F21 | | | | | | | |
| ◀ Double cylinder without deadbolt | | | | | | | | |
| SC8060 - Apartment Entrance | F09 | | | | | | | |
| SC8082 - Institution | F30 | | | | | | | |
| SC8466 - Store Door Lock | F14 | | | | | | | |
| SC8071 - Classroom Security Lock | F32 | | | | | | | |
| SC8457 - Classroom Security w/ DB | F33 | | | | | | | |
| ◀ Other Functions | | | | | | | | |
| SC8458 - Classroom w/ DB & Aux Latch | F34 | | | | | | | |
| SC8040 - Privacy with Deadbolt | F19 | | | | | | | |
| SC8445 - Privacy w/ Deadbolt, Coin turn & Indicator | --- | | | | | | | |
| SC8170 - Single Fixed Dummy | ---- | | | | | | | |
| SC8010 - Passage | F01 | 198.65 | 253.80 | 253.80 | 209.05 | 209.05 | 209.05 | 209.05 |

For pricing & availability inquiries contact your Local Distributor or click [here](#) for the list of our Sales Reps

Optional Interchangeable Cores All keyed lock functions are available with Best, Falcon and Arrow, Schlage, Corbin / Russwin, Sargent, and Yale Large Format Interchangeable Cores

SC Series

HEAVY DUTY, GRADE 1 WIDE ESCUTCHEON MORTISE LOCKSET

Optional Interchangeable Core Small Format (Best, Falcon and Arrow) or Large Format (Schlage)

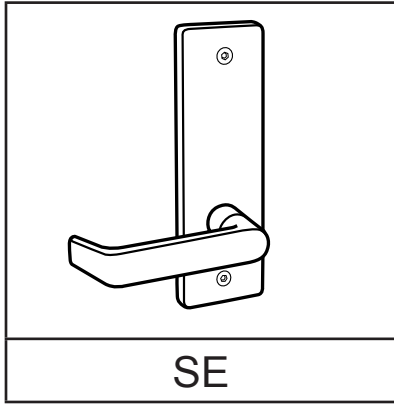

SE WIDE ESCUTCHEON TRIM ONLY

| FUNCTIONS | ANSI | FINISHES | | | | | | |
|---|------|---|-------|------|-------|-----|------|-----|
| | | US26D | US32D | US32 | US10B | US3 | US26 | US4 |
| ◀Single cylinder without deadbolt | | For pricing & availability inquiries contact your Local Distributor or click here for the list of our Sales Reps | | | | | | |
| SC8050 - Office / Entrance | F04 | | | | | | | |
| SC8070 - Classroom | F05 | | | | | | | |
| SC8080 - Storeroom | F07 | | | | | | | |
| ◀Single cylinder with deadbolt | | | | | | | | |
| SC8453 - Entrance | F20 | | | | | | | |
| SC8456 - Corridor | F13 | | | | | | | |
| SC8465 - Closet / Storeroom w/ DB | F65 | | | | | | | |
| SC8495 - Privacy w/ Indicator | ---- | | | | | | | |
| SC8486 - Faculty Restroom w/ Indicator | ---- | | | | | | | |
| SC8473 - Dormitory / Bedroom | F21 | | | | | | | |
| ◀Double cylinder without deadbolt | | | | | | | | |
| SC8060 - Apartment Entrance | F09 | | | | | | | |
| SC8082 - Institution | F30 | | | | | | | |
| SC8466 - Store Door Lock | F14 | | | | | | | |
| SC8071 - Classroom Security Lock | F32 | | | | | | | |
| SC8457 - Classroom Security w/ DB | F33 | | | | | | | |
| ◀Other Functions | | | | | | | | |
| SC8458 - Classroom w/ DB & Aux Latch | F34 | | | | | | | |
| SC8040 - Privacy with Deadbolt | F19 | | | | | | | |
| SC8445 - Privacy w/ Deadbolt, Coin turn & Indicator | --- | | | | | | | |
| SC8170 - Single Fixed Dummy | ---- | | | | | | | |
| SC8010 - Passage | F01 | | | | | | | |

Optional Interchangeable Cores All keyed lock functions are available with Best, Falcon and Arrow, Schlage, Corbin / Russwin, Sargent, and Yale Large Format Interchangeable Cores

SC Series

HEAVY DUTY, GRADE 1 WIDE ESCUTCHEON MORTISE LOCKSET

Optional Interchangeable Core Small Format (Best, Falcon and Arrow) or Large Format (Schlage)

| | | | |
|---|---------------------------------|---|--|
| <p>3 HOUR FIRE RATED UL10C, UBC7-2-1997</p> | <p>LIFETIME WARRANTY</p> | <p>BHMA CERTIFIED Be Safe. Be Secure. Look for the Mark.</p> | <p>MEETS The Buy American Act</p> |
|---|---------------------------------|---|--|

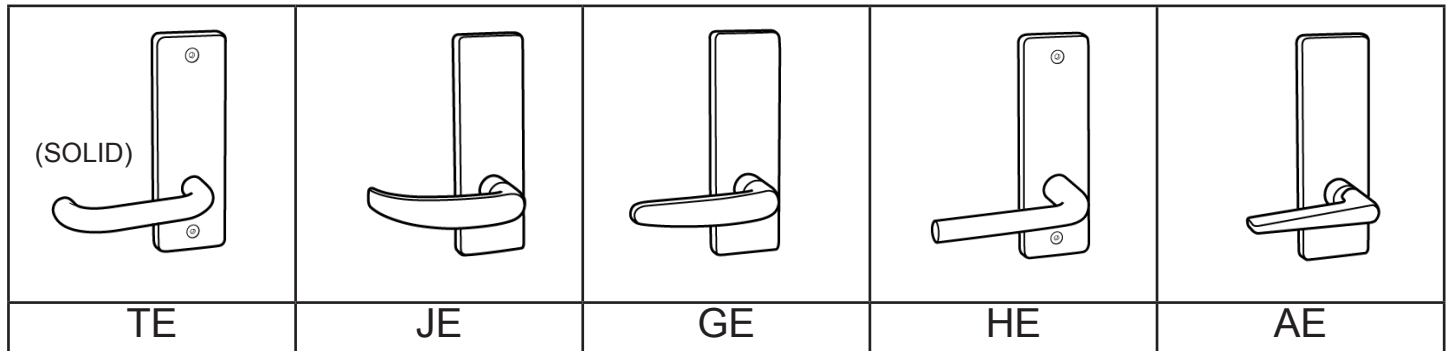

| SE WIDE ESCUTCHEON TRIM ONLY | | | | | | | |
|---|------|----------|-------|------|-------|-----|------|
| FUNCTIONS | ANSI | FINISHES | | | | | |
| | | US26D | US32D | US32 | US10B | US3 | US26 |
| ◀Single cylinder without deadbolt | | | | | | | |
| SC8050 - Office / Entrance | F04 | | | | | | |
| SC8070 - Classroom | F05 | | | | | | |
| SC8080 - Storeroom | F07 | | | | | | |
| ◀Single cylinder with deadbolt | | | | | | | |
| SC8453 - Entrance | F20 | | | | | | |
| SC8456 - Corridor | F13 | | | | | | |
| SC8465 - Closet / Storeroom w/ DB | F65 | | | | | | |
| SC8495 - Privacy w/ Indicator | | | | | | | |
| SC8486 - Faculty Restroom w/ Indicator | ---- | | | | | | |
| SC8473 - Dormitory / Bedroom | F21 | | | | | | |
| ◀Double cylinder without deadbolt | | | | | | | |
| SC8060 - Apartment Entrance | F09 | | | | | | |
| SC8082 - Institution | F30 | | | | | | |
| SC8466 - Store Door Lock | F14 | | | | | | |
| SC8071 - Classroom Security Lock | F32 | | | | | | |
| SC8457 - Classroom Security w/ DB | F33 | | | | | | |
| ◀Other Functions | | | | | | | |
| SC8458 - Classroom w/ DB & Aux Latch | F34 | | | | | | |
| SC8040 - Privacy with Deadbolt | F19 | | | | | | |
| SC8445 - Privacy w/ Deadbolt, Coin turn & Indicator | --- | | | | | | |
| SC8170 - Single Fixed Dummy | ---- | | | | | | |
| SC8010 - Passage | F01 | | | | | | |

For pricing & availability inquiries contact your Local Distributor or click [here](#) for the list of our Sales Reps

Optional Interchangeable Cores All keyed lock functions are available with Best, Falcon and Arrow, Schlage, Corbin / Russwin, Sargent, and Yale Large Format Interchangeable Cores

SC Series

HEAVY DUTY, GRADE 1 MORTISE DEADBOLTS

Optional Interchangeable Core Small Format (Best, Falcon and Arrow) or Large Format (Schlage)

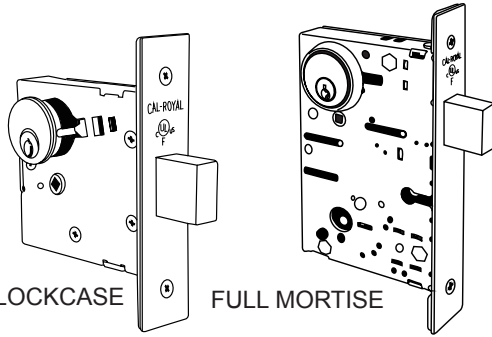

SMALL LOCKCASE

FULL MORTISE

| MODEL# | ANSI | US26D, 32D | US10B, 3, 26, 4 | FUNCTIONS | MODEL# | ANSI | US26D | US32D | US10B, 3, 26, 4 |
|--------|------|--|-----------------|---|--------|------|-------|-------|--|
| SM140 | --- | For pricing & availability inquiries contact your Local Distributor or click here for the list of our Sales Reps | | Cylinder and Thumbturn Deadbolt thrown or retracted by key outside or thumbturn inside. | SC8460 | F17 | | | For pricing & availability inquiries contact your Local Distributor or click here for the list of our Sales Reps |
| SM143 | --- | | | Double Cylinder Deadbolt operated by key on either side. | SC8462 | F16 | | | |
| SM141 | --- | | | Classroom Lock Deadbolt thrown or retracted by key from outside. Inside cylinder turn retracts deadbolt but cannot project it. | SC8463 | F29 | | | |
| SM142 | --- | | | Cylinder Lock Deadbolt thrown or retracted by key from one side. No trim on opposite side. | SC8464 | F18 | | | |
| SM145 | --- | | | Door Bolt Deadbolt thrown or retracted by thumbturn from one side. No trim on opposite side. | SC8461 | --- | | | |
| SM146 | --- | | | Deadbolt with "OCCUPIED" indicator Deadbolt thrown or retracted by key outside or thumbturn inside. "OCC" plate is displayed when deadbolt is thrown. | SC8496 | i | | | |

Optional Interchangeable Cores All keyed lock functions are available with Best, Falcon and Arrow, Schlage, Corbin / Russwin, Sargent, and Yale Large Format Interchangeable Cores

SC Series

HEAVY DUTY, GRADE 1 MORTISE LOCKSET WITH CLUTCH

Optional Interchangeable Core Small Format (Best, Falcon and Arrow) or Large Format (Schlage)

► **PACKAGING INCLUDES**

- 6 locks per case
- UL listed single point latch
- Standard "C", 6-pin cylinder
- Non-handed strike

► **KEYWAYS**

6-pin solid brass "C" keyway standard. Optional: Schlage E, Schlage C-K, Russwin D1-2-3-4, Corbin 59 / 60, Arrow A, Corbin-Russwin L4, Sargent LA-LB-LC, Falcon / Weiser E, Yale 8, Yale GA and Kwikset. Can also accept Medeco, Assa, Kaba and **Cal-Royal HSK** High Security Cylinders.

► When using 1 1/8" length Mortise cylinder for sectional trim and 1 1/4" length Mortise cylinder for Escutcheon **MUST USE SCHLAGE CAM** supplied by Cal-Royal.

Part # KCS7

► **IC CORE**

For **Best, Falcon and Arrow** Interchangeable Core

prefix "**IC**" before **Part #**.
(Mortise housing **Part # ICH961387**)

For **Schlage** Large Format Interchangeable Core prefix "**ICSC**",

For **Corbin / Russwin** Large Format Interchangeable Core prefix "**ICCR**",
For **Sargent** Large Format Interchangeable Core prefix "**ICSA**",
For **Yale** Large Format Interchangeable Core prefix "**ICYA**" before **Part #**.

(Mortise housing **Part # 7000ICMC**)

► **LEAD LINING**

- Part # LEAD

Due to easy reversibility of SC Series, if handing is not available at time of shipment opposite hand will be shipped. ALL PRODUCTS ARE SHIPPED NON-HANDED. EASILY FIELD REVERSIBLE

► FOR 2" up to 2 1/4" Thick door

Order kit:

- SCSKIT200 - for sectional trim
- SCEKIT214 - for escutcheon trim

► **OPTIONAL ADA THUMBTURN**

Prefix "**ADA**" before Mortise lock **ITEM#**
Use **Part # "SCADA"** when ordering separately.

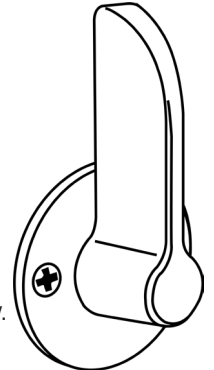

SCADA THUMBTURN

► **TACTILE**

Tactile: Part # TAC

► **ELECTRIFIED**

Available on Storeroom Only

- Electrified Part # ELEC
(Specify Options)

FEATURES:

- UL and CSFM Listings
- Continuous duty solenoids for cooler operation during "continuously on" applications
- Standard plug-in rectifier allows for an AC or DC power source
- Low current draw
- Numerous switch options
- 3 year "No Hassle" warranty

OPTIONS:

- Voltage requirement - 12 VAC / DC or 24 VAC / DC
- Amperage - 700mA @ 12V or 350mA @ 24V
- Function - available "Fail Safe" (FS) or "Fail Secure" (FSE)

- **REX** - Request to Exit

Available on SC8080 and SC8453 Functions

► **ANTI MICROBIAL COATING**

Available on US26D and US32D finishes.

Prefix "**ANTB**" before **Part #**.

► **HOW TO ORDER**

1. Office Function
2. SS Trim Sectional
3. Satin Chrome
4. Right Handed

NM8050 – SS – US26D RH

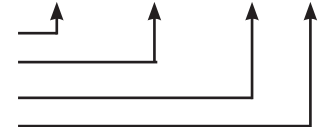

Heavy Duty Mortise Lock COMPARISON CHART

| FUNCTION | ILLUSTRATION | ANSI NO. | CAL-ROYAL MODEL NO | NT FALCON M SERIES | ARROW B Series | CORBIN/RUSSWIN | SARGENT 7800 / 8200 | SCHLAGE L SERIES | PDQ MR SERIES | YALE | HAGER |
|--------------------------------|---|---|--------------------|--------------------|----------------|----------------|---------------------|------------------|----------------|--------|-------|
| ENTRANCE or OFFICE |  | Single Cylinder Without Deadbolt | | | | | | | | | |
| | | F04 | SC8050 | M521 | BM22 | ML2051 | 5 | L9050 | MR116 | 8807 | 3850 |
| CLASSROOM |  | F05 | SC8070 | M561 | BM17 | ML2055 | 37 | L9070 | MR148 | 8808 | 3870 |
| STOREROOM or CLOSET | | F07 | SC8080 | M371 | BM12 | ML2057 | 4 | L9080 | MR115 | 8805 | 3880 |
| APARTMENT / DORMITORY |  | Single Cylinder With Deadbolt | | | | | | | | | |
| | | F20 | SC8453 | M531 | BM11 | ML2067 | 45 | L9453 | MR162 | 8847 | 3853 |
| DORMITORY / BEDROOM |  | F21 | SC8473 | M541 | BM20 | ML2024 | 24 | L9473 | MR135 | 8860 | --- |
| CORRIDOR / EXIT | | F13 | SC8456 | M571 | BM19 | ML2065 | 25 | L9456 | MR136 | 8822 | |
| KEYED PRIVACY INDICATOR |  | --- | SC8495 | M451 | --- | ML2024 M19 | --- | L9495 L9496 | --- | 8864 | --- |
| CLOSET / STOREROOM |  | --- | SC8465 | --- | --- | --- | 27 | L9465 | MR139 | --- | --- |
| APARTMENT ENTRANCE / VESTIBULE |  | Double Cylinder Without Deadbolt | | | | | | | | | |
| | | F09 | SC8060 | M381 | BM32 | ML2042 | 16 | L9060 | MR186 | 8817 | ---- |
| INSTITUTION | | F30 | SC8082 | M411 | BM33 | ML2032 | 17 | L9082 | --- | 8830-2 | 3882 |
| STOREROOM UTILITY |  | Double Cylinder With Deadbolt | | | | | | | | | |
| | | F14 | SC8466 | M371 | BM31 | ML2022 | 26 | L9466 | MR137 | 8860 | ---- |
| PRIVACY or BATHROOM |  | Other Functions | | | | | | | | | |
| | | F02 F19 F22 | SC8040 | M311 | BM02 | ML2020 | 65 | L9040 | MR178 MR179 | 8802 | 3840 |
| | | ---- | SC8445 | ---- | ---- | ML2020 M19 | 49 | ---- | ---- | 8862 | 3896 |
| PASSAGE or CLOSET |  | F01 | SC8010 | M101 | BM01 | ML2010 | 13 | L9010 | MR126 | 8801 | 3810 |
| SINGLE FIXED DUMMY |  | ---- | SC8170 | M12 | BM08 | ML2050 | 93 | L0170 | MR211 | 8855 | 3817 |
| DOUBLE FIXED DUMMY |  | --- | SC8172 | M18 | BM09 | ML2070 | 96 | L0172 | MR205 | 8838 | 3827 |

HL Series

HOSPITAL LATCH (HL TRIM)
HEAVY DUTY, GRADE 1 MORTISE LOCKSET

●● Optional Interchangeable Core Small Format (Best, Falcon and Arrow)
or Large Format (Schlage)

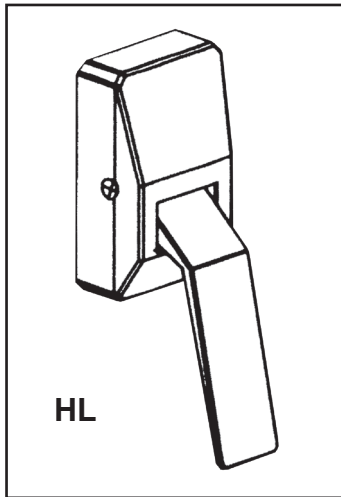

| HL SERIES TRIM ONLY | | | | | | | |
|--|------|---|-------|------|-------|-----|------|
| FUNCTIONS | ANSI | FINISHES | | | | | |
| | | US26D | US32D | US32 | US10B | US3 | US26 |
| ◀Single cylinder without deadbolt | | For pricing & availability inquiries contact your Local Distributor or click here for the list of our Sales Reps | | | | | |
| SC8070HL - Classroom Lock | F05 | | | | | | |
| ◀Single cylinder with deadbolt | | | | | | | |
| SC8453HL - Entrance | F20 | | | | | | |
| SC8456HL - Corridor | F13 | | | | | | |
| SC8473HL - Dormitory / Bedroom | F21 | | | | | | |
| SC8050HL - Office / Entrance | F04 | | | | | | |
| ◀Double cylinder without deadbolt | | | | | | | |
| SC8060HL - Apartment Entrance | F09 | | | | | | |
| SC8082HL - Institution | F30 | | | | | | |
| ◀Double cylinder with deadbolt | | | | | | | |
| SC8411HL - Dormitory or Exit Lock | F11 | | | | | | |
| SC8466HL - Store Door Lock | F14 | | | | | | |
| ◀Other Functions | | | | | | | |
| SC8040HL - Privacy with Deadbolt | F19 | | | | | | |
| SC8049HL - Privacy Bedroom / Bath | F22 | | | | | | |
| SC8010HL - Passage | F01 | | | | | | |

●● All keyed lock functions are available with Best, Falcon and Arrow, Schlage, Corbin / Russwin, Sargent, and Yale Large Format Interchangeable Cores

LG Series

ANTI-LIGATURE LG TRIM

HEAVY DUTY, GRADE 1 MORTISE LOCKSET

Optional Interchangeable Core Small Format (Best, Falcon and Arrow) or Large Format (Schlage)

| | | | |
|---|--------------------------|--|---|
| <small>3 HOUR FIRE RATED UL10C, UBC7-2-1997</small> | LIFETIME WARRANTY | BHMA <small>CERTIFIED</small> <small>Be Safe. Be Secure. Look for the Mark.</small> | MEETS <i>The Buy American Act</i> |
| | | | |

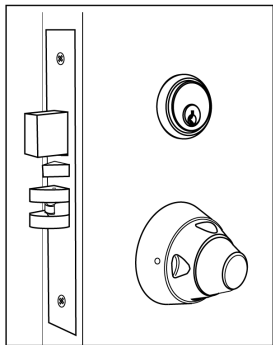

LGK

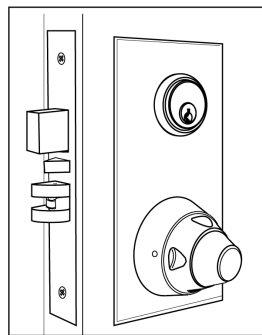

LGX

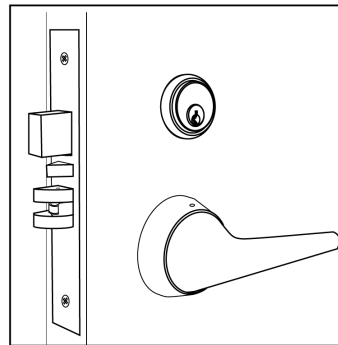

LGS

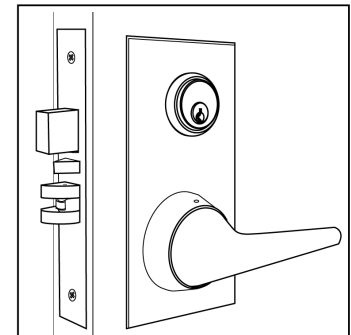

LGE

LG SERIES TRIM ONLY

| FUNCTIONS | ANSI | US32D FINISH | | | |
|---|------|--------------|-----|-----|-----|
| | | LGK | LGX | LGS | LGE |
| ◀Single cylinder without deadbolt | | | | | |
| SC8070LG – Classroom Lock | F05 | | | | |
| SC8007LG – Storeroom Lock | F07 | | | | |
| SC8026LG – Supervisor Office or Privacy Room | F26 | | | | |
| ◀Single cylinder with deadbolt | | | | | |
| SC8050LG – Office / Entrance | F04 | | | | |
| SC8456LG - Corridor | F13 | | | | |
| SC8453LG - Entrance | F20 | | | | |
| SC8473LG - Dormitory / Bedroom | F21 | | | | |
| SC8465LG - Closet / Storeroom w/ DB | F65 | | | | |
| ◀Double cylinder without deadbolt | | | | | |
| SC8060LG - Apartment Entrance | F09 | | | | |
| SC8082LG - Institution / Asylum | F30 | | | | |
| SC8083LG – Lockable Patient Room | F32 | | | | |
| ◀Double cylinder with deadbolt | | | | | |
| SC8411LG – Dormitory or Exit Lock | F11 | | | | |
| SC8457LG – Classroom Security Intruder Deadbolt | F33 | | | | |
| ◀Other Functions | | | | | |
| SC8458LG - Classroom w/ DB & Aux Latch | F34 | | | | |
| SC8010LG – Passage Latch | F01 | | | | |
| SC8049LG – Privacy with Deadbolt | F19 | | | | |
| SC8040LG – Privacy | F22 | | | | |

For pricing & availability inquiries contact your Local Distributor or click [here](#) for the list of our Sales Reps

Optional Interchangeable Cores All keyed lock functions are available with Best, Falcon and Arrow, Schlage, Corbin / Russwin, Sargent, and Yale Large Format Interchangeable Cores

LG Series

ANTI-LIGATURE LG TRIM

HEAVY DUTY, GRADE 1 MORTISE LOCKSET

Optional Interchangeable Core Small Format (Best, Falcon and Arrow) or Large Format (Schlage)



LIFETIME WARRANTY

BHMA CERTIFIED
Be Safe. Be Secure. Look for the Mark.

MEETS
The Buy American Act

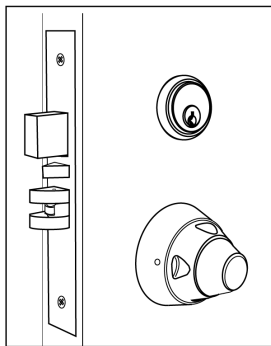

LGK

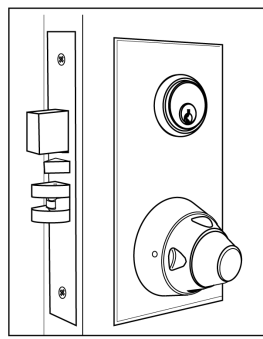

LGX

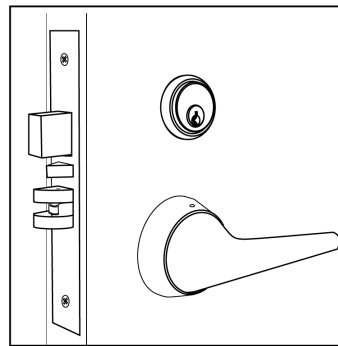

LGS

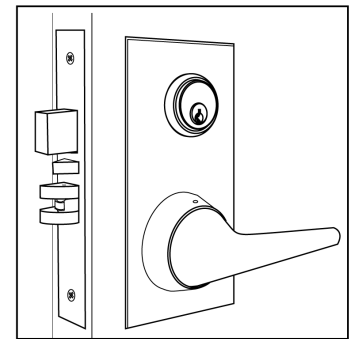

LGE

LG SERIES TRIM ONLY

| FUNCTIONS | | | | | ANSI | US32D FINISH | | | |
|-----------------------------------|----|----|----|----|--|--|-----|-----|-----|
| ◀For Asylum use only no free exit | | | | | IT-Inside Thumbturn IL-Inside Lever IC-Inside Cylinder OC-Outside Cylinder | | | | |
| | IT | IL | IC | OC | | LGK | LGX | LGS | LGE |
| SC8031LG – Asylum | | ✓ | | ✓ | Asylum-1 | For pricing & availability inquiries contact your Local Distributor or click here for the list of our Sales Reps | | | |
| SC8032LG – Asylum | | | ✓ | ✓ | Asylum-2 | | | | |
| SC8033LG – Asylum | | | | ✓ | Asylum-3 | | | | |
| SC8466LG – Store Door Lock | | ✓ | ✓ | ✓ | Asylum-4 (F14) | | | | |
| SC8467LG – Asylum w/ deadbolt | | ✓ | | ✓ | Asylum-5 w/ deadbolt | | | | |
| SC8468LG – Asylum w/ deadbolt | | ✓ | | ✓ | Asylum-6 w/ deadbolt | | | | |
| SC8469LG – Asylum w/ deadbolt | | | | ✓ | Asylum-7 w/ deadbolt | | | | |
| ◀Other Keyed Functions | | | | | | | | | |
| SC8055LG – Female Patient Rm1 | ✓ | ✓ | | ✓ | Female Patient Room-1 | | | | |
| SC8056LG – Female Patient Rm2 | ✓ | ✓ | | ✓ | Female Patient Room-2 | | | | |

Optional Interchangeable Cores All keyed lock functions are available with Best, Falcon and Arrow, Schlage, Corbin / Russwin, Sargent, and Yale Large Format Interchangeable Cores

HOSPITAL PUSH / PULL LATCH

FOR 1 3/4" THICK DOORS



FEATURES

- UL-listed for use on all fire doors
- Meets ADA requirements
- Ideal for use in hospitals, washrooms or public buildings
- 6 possible PUSH-PULL mounting combinations
- Covers and paddles are made of stainless steel
- Non-Handed
- Standard T-Strike and plastic dust box
- 1 3/4" door thickness
- 2 3/4" backset standard, face plate 1 1/8" x 2 1/4"
- Optional 5" backsets
- 2 5/8" X 4 3/8" Covers
- 2 5/8" Handle Projection

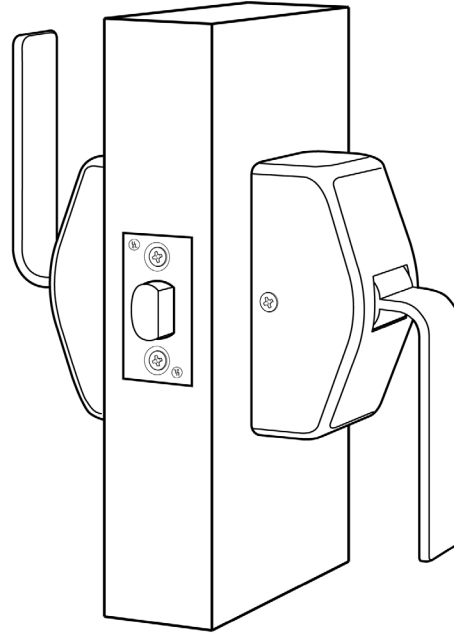













OPTIONS AVAILABLE

- Lead Lining
- Anti-Microbial
- ASA Strike

| ITEM# | FUNCTIONS | DESCRIPTION | FINISH | PCS / INNER BOX | PCS / MC | UOM | |
|---------------|-----------|---|--|-----------------|----------|-----|--|
| | | | US32D | | | | |
| HOS-PP30 | Passage | Hospital Push / Pull Latch, Non-Handed Passage Function, UL- Listed, 2 3/4" or 5" Backset | For pricing & availability inquiries contact your Local Distributor or click here for the list of our Sales Reps | 1 | 10 | Ea. | |
| ULHOS-PAS-5 | Latchbolt | UL- Listed 5" Backset Privacy / Passage Latch | | 20 | 100 | | |
| ULHOS-PAS-234 | | UL- Listed 2 3/4" Backset Privacy / Passage Latch | | 20 | 100 | | |
| HOS-ANTB | Add on | Anti Microbial Coating (Inside and Outside surfaces) | | | | | |
| HOS-LEAD | | LEAD LINING | | | | | |
| ASAST | Strike | ASA ANSI Strike | | | | | |
| EXASA-175 | Strike | Extended Lip ANSI Strike | | US32D, DURO | | | |

Heavy Duty Mortise Lock COMPARISON CHART

| FUNCTION | ILLUSTRATION | ANSI NO. | CAL-ROYAL MODEL NO | NT FALCON M SERIES | ARROW B Series | CORBIN/RUSSWIN | SARGENT 7800 / 8200 | SCHLAGE L SERIES | PDQ MR SERIES | YALE | HAGER |
|--------------------------------|---|---|--------------------|--------------------|----------------|----------------|---------------------|------------------|----------------|--------|-------|
| ENTRANCE or OFFICE |  | Single Cylinder Without Deadbolt | | | | | | | | | |
| | | F04 | NM8050 | M521 | BM22 | ML2051 | 5 | L9050 | MR116 | 8807 | 3850 |
| CLASSROOM |  | F05 | NM8070 | M561 | BM17 | ML2055 | 37 | L9070 | MR148 | 8808 | 3870 |
| STOREROOM or CLOSET | | F07 | NM8080 | M371 | BM12 | ML2057 | 4 | L9080 | MR115 | 8805 | 3880 |
| APARTMENT / DORMITORY |  | Single Cylinder With Deadbolt | | | | | | | | | |
| | | F20 | NM8453 | M531 | BM11 | ML2067 | 45 | L9453 | MR162 | 8847 | 3853 |
| DORMITORY / BEDROOM |  | F21 | NM8473 | M541 | BM20 | ML2024 | 24 | L9473 | MR135 | 8860 | --- |
| CORRIDOR / EXIT | | F13 | NM8456 | M571 | BM19 | ML2065 | 25 | L9456 | MR136 | 8822 | --- |
| KEYED PRIVACY INDICATOR |  | --- | NM8495 | M451 | --- | ML2024 M19 | --- | L9495 L9496 | --- | 8864 | --- |
| CLOSET / STOREROOM |  | --- | NM8465 | --- | --- | --- | 27 | L9465 | MR139 | --- | --- |
| APARTMENT ENTRANCE / VESTIBULE |  | Double Cylinder Without Deadbolt | | | | | | | | | |
| | | F09 | NM8060 | M381 | BM32 | ML2042 | 16 | L9060 | MR186 | 8817 | ---- |
| INSTITUTION | | F30 | NM8082 | M411 | BM33 | ML2032 | 17 | L9082 | --- | 8830-2 | 3882 |
| STOREROOM UTILITY |  | Double Cylinder With Deadbolt | | | | | | | | | |
| | | F14 | NM8466 | M371 | BM31 | ML2022 | 26 | L9466 | MR137 | 8860 | ---- |
| PRIVACY or BATHROOM |  | Other Functions | | | | | | | | | |
| | | F02 F19 F22 | NM8040 | M311 | BM02 | ML2020 | 65 | L9040 | MR178 MR179 | 8802 | 3840 |
| PRIVACY WITH INDICATOR | | ---- | NM8445 | ---- | ---- | ML2020 M19 | 49 | ---- | ---- | 8862 | 3896 |
| PASSAGE or CLOSET |  | F01 | NM8010 | M101 | BM01 | ML2010 | 13 | L9010 | MR126 | 8801 | 3810 |
| SINGLE FIXED DUMMY |  | ---- | NM8170 | M12 | BM08 | ML2050 | 93 | L0170 | MR211 | 8855 | 3817 |
| DOUBLE FIXED DUMMY |  | --- | NM8172 | M18 | BM09 | ML2070 | 96 | L0172 | MR205 | 8838 | 3827 |

GENESYS Series

HEAVY DUTY CYLINDRICAL LEVERSETS WITH CLUTCH

ANSI - A156.2, SERIES 4000, GRADE 1

● Optional Interchangeable Core for **Best, Falcon and Arrow**

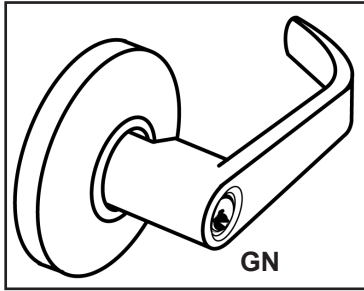

| FUNCTIONS | ANSI | ITEM# | US26D | US10B | US3 | US10 | US26 | US4 | PCS / MC |
|--|------|-----------|--|-------|-----|------|------|-----|----------|
| Entrance | F109 | CGN00 | For pricing & availability inquiries contact your Local Distributor or click here for the list of our Sales Reps | | | | | | 10 |
| | | ● ICCGN00 | | | | | | | |
| Entrance Push Button Lock | F82 | CGN01 | | | | | | | |
| | | ● ICCGN01 | | | | | | | |
| Store lock Non Clutch (keyed Dbl. cyl.) | F91 | GN02 | | | | | | | |
| | | ● ICGN02 | | | | | | | |
| Classroom | F84 | CGN03 | | | | | | | |
| | | ● ICCGN03 | | | | | | | |
| Communicating (keyed Dbl. cyl.) | F80 | CGN04 | | | | | | | |
| | | ● ICCGN04 | | | | | | | |
| Storeroom | F86 | CGN05 | | | | | | | |
| | | ● ICCGN05 | | | | | | | |
| Vestibule | F88 | CGN06 | | | | | | | |
| | | ● ICCGN06 | | | | | | | |
| Classroom / Intruder | F110 | CGN07 | | | | | | | |
| | | ● ICCGN07 | | | | | | | |
| Dormitory (Non-Clutch) | F90 | GN101 | | | | | | | |
| Institution (keyed Dbl. cyl.) | F87 | CGN09 | | | | | | | |
| | | ● ICCGN09 | | | | | | | |
| Privacy | F76 | CGN20 | | | | | | | |
| Hospital Privacy | --- | HCGN20 | | | | | | | |
| Passage | F75 | GN30 | | | | | | | |
| Exit | F89 | GN50 | | | | | | | |
| Single Dummy | ---- | GN40 | | | | | | | 20 |

● (IC) Indicates function available with **Best, Falcon and Arrow** Interchangeable Core.

HEAVY DUTY CYLINDRICAL LEVERSETS WITH CLUTCH ANSI - A156.2, SERIES 4000, GRADE 1

Ⓢ Optional Interchangeable Core for **Best, Falcon and Arrow**

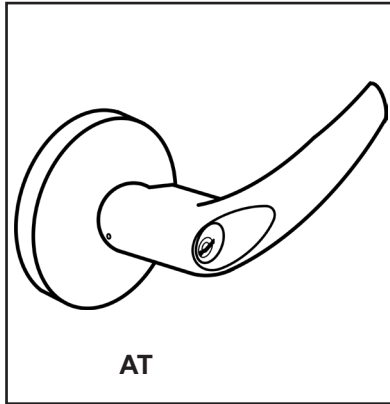

**LIFETIME
WARRANTY**

**BHMA
CERTIFIED**
Be Safe. Be Secure. Look for the Mark.

MEETS
The Buy American Act



| FUNCTIONS | ANSI | ITEM# | US26D | US10B | US3 | US10 | US26 | US4 | PCS / MC |
|--|------|------------------|--|-------|-----|------|------|-----|----------|
| Entrance | F109 | CAT00 | For pricing & availability inquiries contact your Local Distributor or click here for the list of our Sales Reps | | | | | | 10 |
| | | Ⓢ ICCAT00 | | | | | | | |
| Entrance Push Button Lock | F82 | CAT01 | | | | | | | |
| | | Ⓢ ICCAT01 | | | | | | | |
| Store lock Non Clutch (keyed Dbl. cyl.) | F91 | AT02 | | | | | | | |
| | | Ⓢ ICAT02 | | | | | | | |
| Classroom | F84 | CAT03 | | | | | | | |
| | | Ⓢ ICCAT03 | | | | | | | |
| Communicating (keyed Dbl. cyl.) | F80 | CAT04 | | | | | | | |
| | | Ⓢ ICCAT04 | | | | | | | |
| Storeroom | F86 | CAT05 | | | | | | | |
| | | Ⓢ ICCAT05 | | | | | | | |
| Vestibule | F88 | CAT06 | | | | | | | |
| | | Ⓢ ICCAT06 | | | | | | | |
| Classroom / Intruder | F110 | CAT07 | | | | | | | |
| | | Ⓢ ICCAT07 | | | | | | | |
| Institution (keyed Dbl. cyl.) | F87 | CAT09 | | | | | | | |
| | | Ⓢ ICCAT09 | | | | | | | |
| Privacy | F76 | CAT20 | | | | | | | |
| Hospital Privacy | --- | HCAT20 | | | | | | | |
| Passage | F75 | AT30 | | | | | | | |
| Exit | F89 | AT50 | | | | | | | |
| Single Dummy | ---- | AT40 | | | | | | | 20 |

Ⓢ (IC) Indicates function available with **Best, Falcon and Arrow** Interchangeable Core.

HEAVY DUTY CYLINDRICAL LEVERSETS WITH CLUTCH ANSI - A156.2, SERIES 4000, GRADE 1

Optional Interchangeable Core for **Best, Falcon and Arrow**

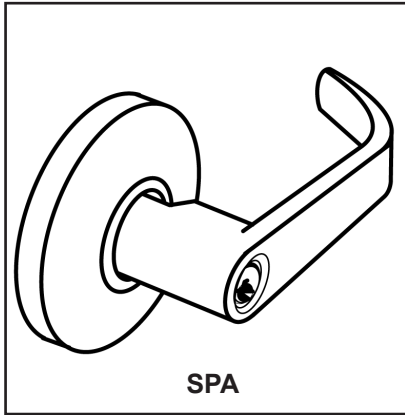

| FUNCTIONS | ANSI | ITEM# | US26D | US10B | US3 | US10 | US26 | US4 | PCS / MC | | | | | | | | | | | | | | | | | | | | | | | | | | | | | | | | | | | | | | | | | | | | | | | | | |
|--|------|-----------|---|-------|-----|------|------|-----|----------|--|--|--|--|--|--|--|--|--|--|--|--|--|----|--|--|--|--|--|--|--|--|--|--|--|--|--|--|--|--|--|--|--|--|--|--|--|--|--|--|--|--|--|--|--|--|--|--|--|
| Entrance | F109 | CSPA00 | For pricing & availability inquiries contact your Local Distributor or click here for the list of our Sales Reps | | | | | | 10 | | | | | | | | | | | | | | | | | | | | | | | | | | | | | | | | | | | | | | | | | | | | | | | | | |
| | | ● ICSPA00 | | | | | | | | | | | | | | | | | | | | | | | | | | | | | | | | | | | | | | | | | | | | | | | | | | | | | | | | |
| Entrance Push Button Lock | F82 | CSPA01 | | | | | | | | | | | | | | | | | | | | | | | | | | | | | | | | | | | | | | | | | | | | | | | | | | | | | | | | |
| | | ● ICSPA01 | | | | | | | | | | | | | | | | | | | | | | | | | | | | | | | | | | | | | | | | | | | | | | | | | | | | | | | | |
| Store lock Non Clutch (keyed Dbl. cyl.) | F91 | SPA02 | | | | | | | | | | | | | | | | | | | | | | | | | | | | | | | | | | | | | | | | | | | | | | | | | | | | | | | | |
| | | ● ICSPA02 | | | | | | | | | | | | | | | | | | | | | | | | | | | | | | | | | | | | | | | | | | | | | | | | | | | | | | | | |
| Classroom | F84 | CSPA03 | | | | | | | | | | | | | | | | | | | | | | | | | | | | | | | | | | | | | | | | | | | | | | | | | | | | | | | | |
| | | ● ICSPA03 | | | | | | | | | | | | | | | | | | | | | | | | | | | | | | | | | | | | | | | | | | | | | | | | | | | | | | | | |
| Communicating (keyed Dbl. cyl.) | F80 | CSPA04 | | | | | | | | | | | | | | | | | | | | | | | | | | | | | | | | | | | | | | | | | | | | | | | | | | | | | | | | |
| | | ● ICSPA04 | | | | | | | | | | | | | | | | | | | | | | | | | | | | | | | | | | | | | | | | | | | | | | | | | | | | | | | | |
| Storeroom | F86 | CSPA05 | | | | | | | | | | | | | | | | | | | | | | | | | | | | | | | | | | | | | | | | | | | | | | | | | | | | | | | | |
| | | ● ICSPA05 | | | | | | | | | | | | | | | | | | | | | | | | | | | | | | | | | | | | | | | | | | | | | | | | | | | | | | | | |
| Vestibule | F88 | CSPA06 | | | | | | | | | | | | | | | | | | | | | | | | | | | | | | | | | | | | | | | | | | | | | | | | | | | | | | | | |
| | | ● ICSPA06 | | | | | | | | | | | | | | | | | | | | | | | | | | | | | | | | | | | | | | | | | | | | | | | | | | | | | | | | |
| Classroom / Intruder | F110 | CSPA07 | | | | | | | | | | | | | | | | | | | | | | | | | | | | | | | | | | | | | | | | | | | | | | | | | | | | | | | | |
| | | ● ICSPA07 | | | | | | | | | | | | | | | | | | | | | | | | | | | | | | | | | | | | | | | | | | | | | | | | | | | | | | | | |
| Institution (keyed Dbl. cyl.) | F87 | CSPA09 | | | | | | | | | | | | | | | | | | | | | | | | | | | | | | | | | | | | | | | | | | | | | | | | | | | | | | | | |
| | | ● ICSPA09 | | | | | | | | | | | | | | | | | | | | | | | | | | | | | | | | | | | | | | | | | | | | | | | | | | | | | | | | |
| Privacy | F76 | CSPA20 | | | | | | | | | | | | | | | | | | | | | | | | | | | | | | | | | | | | | | | | | | | | | | | | | | | | | | | | |
| Hospital Privacy | --- | HCSA20 | | | | | | | | | | | | | | | | | | | | | | | | | | | | | | | | | | | | | | | | | | | | | | | | | | | | | | | | |
| Passage | F75 | SPA30 | | | | | | | | | | | | | | | | | | | | | | | | | | | | | | | | | | | | | | | | | | | | | | | | | | | | | | | | |
| Exit | F89 | SPA50 | | | | | | | | | | | | | | | | | | | | | | | | | | | | | | | | | | | | | | | | | | | | | | | | | | | | | | | | |
| Single Dummy | ---- | SPA40 | | | | | | | | | | | | | | | | | | | | | | | | | | | | | | | | | | | | | | | | | | | | | | | | | | | | | | | | |
| | | | | | | | | | | | | | | | | | | | | | | | 20 | | | | | | | | | | | | | | | | | | | | | | | | | | | | | | | | | | | |

● (IC) Indicates function available with **Best, Falcon and Arrow** Interchangeable Core.

HEAVY DUTY CYLINDRICAL LEVERSETS WITH CLUTCH ANSI - A156.2, SERIES 4000, GRADE 1

 Optional Interchangeable Core for **Best, Falcon and Arrow**

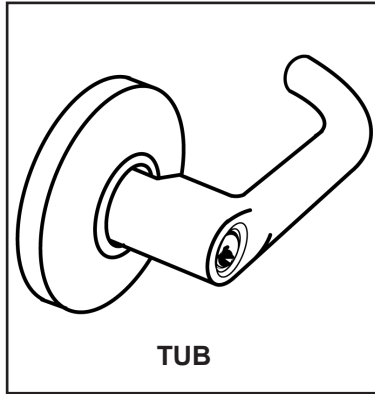









LIFETIME WARRANTY

BHMA CERTIFIED
Be Safe. Be Secure. Look for the Mark.

MEETS
The Buy American Act



| FUNCTIONS | ANSI | ITEM# | US26D | US10B | US3 | US10 | US26 | US4 | PCS / MC |
|--|------|--|--|-------|-----|------|------|-----|----------|
| Entrance | F109 | CTUB00 | For pricing & availability inquiries contact your Local Distributor or click here for the list of our Sales Reps | | | | | | 10 |
| | |  ICCTUB00 | | | | | | | |
| Entrance Push Button Lock | F82 | CTUB01 | | | | | | | |
| | |  ICCTUB01 | | | | | | | |
| Store lock Non Clutch (keyed Dbl. cyl.) | F91 | TUB02 | | | | | | | |
| | |  ICTUB02 | | | | | | | |
| Classroom | F84 | CTUB03 | | | | | | | |
| | |  ICCTUB03 | | | | | | | |
| Communicating (keyed Dbl. cyl.) | F80 | CTUB04 | | | | | | | |
| | |  ICCTUB04 | | | | | | | |
| Storeroom | F86 | CTUB05 | | | | | | | |
| | |  ICCTUB05 | | | | | | | |
| Vestibule | F88 | CTUB06 | | | | | | | |
| | |  ICCTUB06 | | | | | | | |
| Classroom / Intruder | F110 | CTUB07 | | | | | | | |
| | |  ICCTUB07 | | | | | | | |
| Institution (keyed Dbl. cyl.) | F87 | CTUB09 | | | | | | | |
| | |  ICCTUB09 | | | | | | | |
| Privacy | F76 | CTUB20 | | | | | | | |
| Hospital Privacy | --- | HCTUB20 | | | | | | | |
| Passage | F75 | TUB30 | | | | | | | |
| Exit | F89 | TUB50 | | | | | | | |
| Single Dummy | ---- | TUB40 | | | | | | | |
| | | | | | | | | | 20 |

 (IC) Indicates function available with **Best, Falcon and Arrow** Interchangeable Core.

HEAVY DUTY CYLINDRICAL LEVERSETS WITH CLUTCH ANSI - A156.2, SERIES 4000, GRADE 1

Optional Full Size Interchangeable Core for **Corbin/Ruswin, Sargent and Yale**

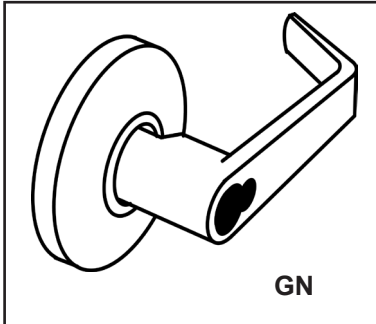

LIFETIME WARRANTY

BHMA CERTIFIED
Be Safe. Be Secure. Look for the Mark.

MEETS
The Buy American Act



CORBIN/RUSSWIN (Large Format Interchangeable Core) **7 OR 6 PIN ONLY**

| FUNCTIONS | ANSI | ITEM# | US26D | US10B | US3 | US10 | US26 | US4 | PCS / MC |
|---------------------------------|------|--------------|--|-------|-----|------|------|-----|----------|
| Entrance | F109 | ● RUSICCGN00 | For pricing & availability inquiries contact your Local Distributor or click here for the list of our Sales Reps | | | | | | 10 |
| Classroom | F84 | ● RUSICCGN03 | | | | | | | |
| Communicating (keyed Dbl. cyl.) | F80 | ● RUSICCGN04 | | | | | | | |
| Storeroom | F86 | ● RUSICCGN05 | | | | | | | |
| Vestibule | F88 | ● RUSICCGN06 | | | | | | | |
| Classroom / Intruder | F110 | ● RUSICCGN07 | | | | | | | |
| Institution (keyed Dbl. cyl.) | F87 | ● RUSICCGN09 | | | | | | | |
| Dormitory (Non-Clutch) | F90 | ● RUSICGN101 | | | | | | | |

SARGENT (Large Format Interchangeable Core) **6 PIN ONLY**

| FUNCTIONS | ANSI | ITEM# | US26D | US10B | US3 | US10 | US26 | US4 | PCS / MC |
|---------------------------------|------|--------------|--|-------|-----|------|------|-----|----------|
| Entrance | F109 | ● SARICCGN00 | For pricing & availability inquiries contact your Local Distributor or click here for the list of our Sales Reps | | | | | | 10 |
| Classroom | F84 | ● SARICCGN03 | | | | | | | |
| Communicating (keyed Dbl. cyl.) | F80 | ● SARICCGN04 | | | | | | | |
| Storeroom | F86 | ● SARICCGN05 | | | | | | | |
| Vestibule | F88 | ● SARICCGN06 | | | | | | | |
| Classroom / Intruder | F110 | ● SARICCGN07 | | | | | | | |
| Institution (keyed Dbl. cyl.) | F87 | ● SARICCGN09 | | | | | | | |
| Dormitory (Non-Clutch) | F90 | ● SARICGN101 | | | | | | | |

YALE (Large Format Interchangeable Core) **6 PIN ONLY**

| FUNCTIONS | ANSI | ITEM# | US26D | US10B | US3 | US10 | US26 | US4 | PCS / MC |
|---------------------------------|------|--------------|--|-------|-----|------|------|-----|----------|
| Entrance | F109 | ● YALICCGN00 | For pricing & availability inquiries contact your Local Distributor or click here for the list of our Sales Reps | | | | | | 10 |
| Classroom | F84 | ● YALICCGN03 | | | | | | | |
| Communicating (keyed Dbl. cyl.) | F80 | ● YALICCGN04 | | | | | | | |
| Storeroom | F86 | ● YALICCGN05 | | | | | | | |
| Vestibule | F88 | ● YALICCGN06 | | | | | | | |
| Classroom / Intruder | F110 | ● YALICCGN07 | | | | | | | |
| Institution (keyed Dbl. cyl.) | F87 | ● YALICCGN09 | | | | | | | |
| Dormitory (Non-Clutch) | F90 | ● YALICGN101 | | | | | | | |

● (IC) Indicates function available with Corbin / Ruswin, Sargent, and Yale Full Size Interchangeable Core.

HEAVY DUTY CYLINDRICAL LEVERSETS WITH CLUTCH ANSI - A156.2, SERIES 4000, GRADE 1

⌘ Optional Full Size Interchangeable Core for **SCHLAGE**

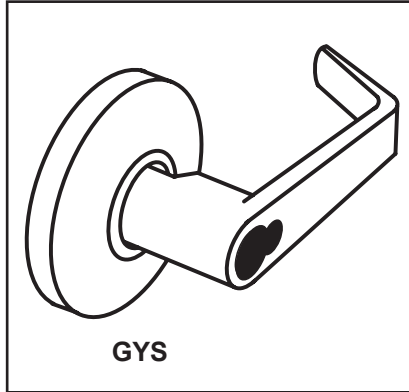

**LIFETIME
WARRANTY**

**BHMA
CERTIFIED**
Be Safe. Be Secure. Look for the Mark.

MEETS
The Buy American Act

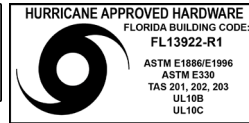

SCHLAGE (Large Format Interchangeable Core) **6 PIN ONLY**

| FUNCTIONS | ANSI | ITEM# | US26D | US10B | US3 | US10 | US26 | US4 | PCS / MC |
|---------------------------------|------|------------|--|-------|-----|------|------|-----|----------|
| Entrance | F109 | ⌘ ICGYS00 | For pricing & availability inquiries contact your Local Distributor or click here for the list of our Sales Reps | | | | | | 10 |
| Storeroom | F86 | ⌘ ICGYS05 | | | | | | | |
| Classroom | F84 | ⌘ ICGYS03 | | | | | | | |
| Communicating (keyed Dbl. cyl.) | F80 | ⌘ ICGYS04 | | | | | | | |
| Vestibule | F88 | ⌘ ICGYS06 | | | | | | | |
| Classroom/ Intruder | F110 | ⌘ ICGYS07 | | | | | | | |
| Institution (keyed Dbl. cyl.) | F87 | ⌘ ICGYS09 | | | | | | | |
| Dormitory (Non-Clutch) | F90 | ⌘ ICGYS101 | | | | | | | |

⌘ (IC) Indicates function available with **Schlage** Full Size Interchangeable Core.

► **PACKAGING INCLUDES**

- UL Listed 2 3/4" Backset, 2 1/4" x 1 1/8" faceplate
- Standard "C", 6-pin cylinder
- ASA strike
- **For 2" up to 2 1/4" Thick Door Use Part # below.**

| | |
|---|--|
| CGN214T00 - Entrance, CGN00 | CGN214T05 - Storeroom, CGN05 |
| GN214T02 - Store Lock, GN02 | CGN214T09 - Institution, CGN09 |
| CGN214T03 - Classroom, CGN03 | CGN214T20 - Privacy, CGN20 |
| CGN214T04 - Communicating, CGN04 | GN214T30 - Passage, GN30 |
| ● ICCGN214T00 - Entrance, ICCGN00 | Available on AT, SPA & TUB Design. Use same Part No. |
| ● ICCGN214T03 - Classroom, ICCGN03 | |
| ● ICCGN214T05 - Storeroom, ICCGN05 | |

► **KEYWAYS**

6-pin solid brass "C" keyway standard. Optional: Schlage E, Schlage C-K, Russwin D1-2-3-4, Corbin 59 / 60, Corbin-Russwin L4, Sargent LA-LB-LC, Falcon / Weiser E, Arrow A, Yale 8, Yale GA and Kwikset. Can also accept Medeco, Assa, Kaba and **Cal-Royal HSK** High Security Cylinders.

► **MOUNT**

1 hole wooden mount
Part # CGNMOUNT

► **ANTI MICROBIAL COATING**

Available on US26D finish only.
Prefix "ANTB" before Part #.

► **TACTILE / LEAD LINING**

- Lead Lining Part # **LEAD**
- Tactile Part # **TAC**

► **ELECTRIFIED**



Available on Storeroom Only

- Electrified Part # **ELEC**
Specify 12V or 24V, fail safe (SAF) or fail secure (SEC)

| ELECTRIFIED | | | | |
|-----------------------------------|---------------|--|-------|-----|
| DESCRIPTION | ITEM # | US26D | US10B | US4 |
| FAIL SAFE OPTION 12V AC / DC | EICGN0512SAF | For pricing & availability inquiries contact your Local Distributor or click here for the list of our Sales Reps | | |
| | EICGN0512SAF | | | |
| | EICGYS0512SAF | | | |
| FAIL SECURE OPTION 12V AC / DC | EICGN0512SEC | | | |
| | EICGN0512SEC | | | |
| | EICGYS0512SEC | | | |
| FAIL SAFE OPTION 24V AC / DC | EICGN0524SAF | | | |
| | EICGN0524SAF | | | |
| | EICGYS0524SAF | | | |
| FAIL SECURE OPTION 24V AC / DC | EICGN0524SEC | | | |
| | EICGN0524SEC | | | |
| | EICGYS0524SEC | | | |

► **ADDITIONAL PARTS FOR GENESYS SERIES**

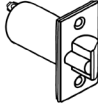
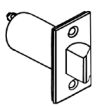
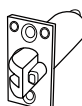
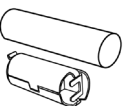
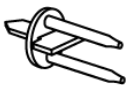
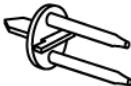
Backsets: UL listed 2 3/8", 2 1/4" x 1" Faceplate

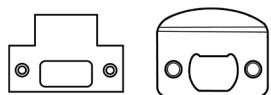
| ILLUSTRATION | ITEM # | DESCRIPTION | FINISH | |
|--|------------|--|-----------------------------|--|
|  | GND238 | CGN Series Dead Latch 2 3/8", 2 1/4" x 1" Faceplate | US3, 26D, 10B | For pricing & availability inquiries contact your Local Distributor or click here for the list of our Sales Reps |
|  | GNS238 | CGN Series Spring Latch 2 3/8", 2 1/4" X 1" Faceplate | US3, 26D, 10B | |
|  | GND750 | 3/4" throw, anti-friction Dead Latch for pairs of fire doors, 2 1/4" x 1 1/8" Faceplate | US3, 26D, 10B, 10 | |
|  | GEN5 EXT | 5" Backset Extension Link | ----- | |
| | GEN334 EXT | 3 3/4" Backset Extension Link | | |
| TAIL PIECE | | | | |
|  | ICTP-01 | 6-pin Tail Piece for IC Genesys Series | | For pricing & availability inquiries contact your Local Distributor or click here for the list of our Sales Reps |
|  | ICTP-02 | 7 Pin Tail Piece for IC Genesys Series | | |
|  | ICTP-07 | Tail Piece for Schlage Large Format IC Core | | |
| EXTRA UL LISTED BACKSET | | | | |
|  | GND234 | CGN Series 2 3/4" Dead latch, 2 1/4" x 1 1/8" Faceplate | US3, 26D, 10B | For pricing & availability inquiries contact your Local Distributor or click here for the list of our Sales Reps |
| STRIKES | | | | |
|  | TS | T-Strike | US3, 26D, 10B, 26, 10, 4 | For pricing & availability inquiries contact your Local Distributor or click here for the list of our Sales Reps |
| | FLS | Full Lip Strike, Round Corner | | |

CALYPSO Series

EXTRA HEAVY DUTY CYLINDRICAL LEVERSETS

ANSI - A156.2, SERIES 4000, GRADE 1

⌘ Optional Interchangeable Core for Best, Falcon and Arrow

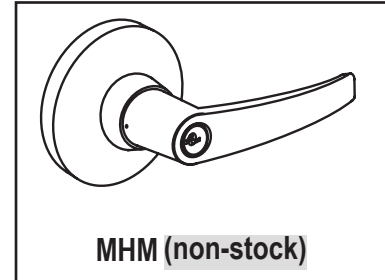
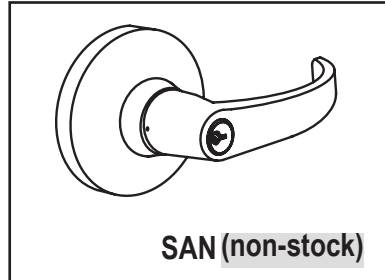
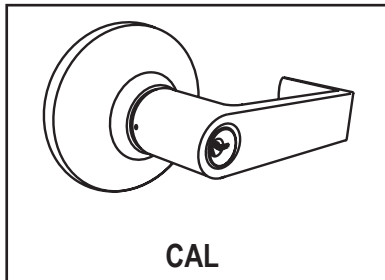

When ordering: "SAN" or "MHM" design **Example:** CAL00 Entrance in "SAN" design is SAN00 or in "MHM" design is MHM00

| FUNCTION | ANSI | ITEM # | US26D | US10B, 3, 10, 26, 4 | PCS / MC |
|--------------------|------|------------------------|--|---------------------|----------|
| Entrance | F109 | ⌘ CAL00 ⌘ ICCAL00 | For pricing & availability inquiries contact your Local Distributor or click here for the list of our Sales Reps | | 6 |
| Storelock | F91 | ⌘ CAL02 ⌘ ICCAL02 | | | |
| Classroom | F84 | ⌘ CAL03 ⌘ ICCAL03 | | | |
| Communicating | F80 | ⌘ CAL04 ⌘ ICCAL04 | | | |
| Storeroom | F86 | ⌘ CAL05 ⌘ ICCAL05 | | | |
| Vestibule | F88 | ⌘ CAL06 ⌘ ICCAL06 | | | |
| Classroom Intruder | F110 | ⌘ CAL07 ⌘ ICCAL07 | | | |
| Institution | F87 | ⌘ CAL09 ⌘ ICCAL09 | | | |
| Dormitory | F90 | ⌘ CAL101 ⌘ ICCAL101 | | | |
| Privacy | F76 | CAL20 | | | |
| Passage | F75 | CAL30 | | | |
| Dummy | ---- | CAL40 | | | 12 |

⌘ (IC) Indicates function available with Best, Falcon and Arrow Interchangeable Core.

► **PACKAGING INCLUDES**

UL Listed 2 3/4" Backset, 2 1/4" x 1 1/8" faceplate, Standard "C", 6-pin cylinder, ASA Strike

► **KEYWAYS**

6-pin solid brass "C" keyway standard. Optional: Schlage E, Schlage C-K, Russwin D1-2-3-4, Corbin 59 / 60, Corbin-Russwin L4, Sargent LA-LB-LC, Falcon / Weiser E, Arrow A, Yale 8, Yale GA and Kwikset. Can also accept Medeco, Assa, Kaba and *Cal-Royal HSK High Security Cylinders*.

► **TACTILE / LEAD LINING**

- Lead Lining Part # **LEAD**
- Tactile Part # **TAC**

► **ANTI MICROBIAL COATING**

Available on US26D finish only.
Prefix "**ANTB**" before **Part #**.

► **ADDITIONAL PARTS FOR CALYPSO SERIES**

Backsets: UL listed 2 3/8", 2 1/4" x 1 1/8" faceplate

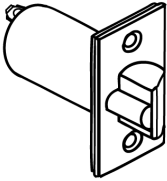
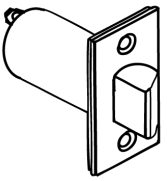
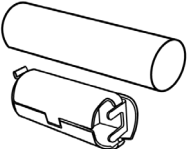
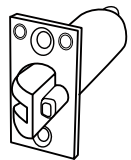
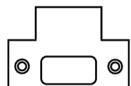
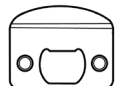
| ILLUSTRATION | ITEM # | DESCRIPTION | FINISH | | |
|---|------------|---|-----------------------------|--|--|
| EXTRA UL BACKSET | | | | | |
|  | CALSLD238 | CAL Series Dead latch 2 3/8" 2 1/4" x 1 1/8" Faceplate | US26D | For pricing & availability inquiries contact your Local Distributor or click here for the list of our Sales Reps | |
| | CALDOR238 | CAL101 Dormitory Dead latch 2 3/8" 2 1/4" x 1 1/8" Faceplate | US26D | | |
|  | CALSLS238 | CAL Series Spring Latch 2 3/8" 2 1/4" x 1 1/8" Faceplate | US26D | | |
| | CALSPL238 | CAL Series Privacy Latch 2 3/8" 2 1/4" x 1 1/8" Faceplate | US26D | | |
|  | CAL334 EXT | CAL Series 3 3/4" Extension Link To be used with CALSLD238 | ---- | | |
| | CAL5 EXT | CAL Series 5" Extension Link | ---- | | |
|  | CAL750 | 2 3/4" Backset, 2 1/4" x 1 1/8" faceplate, 3/4" throw, anti-friction Dead latch for pairs of fire doors | US26D | | |
| STRIKES | | | | | |
|  | TS | T-Strike | US3, 26D, 10B, 26, 10, 4 | | For pricing & availability inquiries contact your Local Distributor or click here for the list of our Sales Reps |
|  | FLS | Full Lip Strike Round Corner | | | |

OMEGA GRB Series

HEAVY DUTY CYLINDRICAL LEVERSETS

ANSI - A156.2, SERIES 4000, GRADE 1

⌘ Optional Interchangeable Core for Best, Falcon and Arrow

| | | | |
|---|--------------------------|--|---|
|  | LIFETIME WARRANTY | BHMA CERTIFIED <small>Be Safe. Be Secure. Look for the Mark.</small> | MEETS <i>The Buy American Act</i> |
|---|--------------------------|--|---|

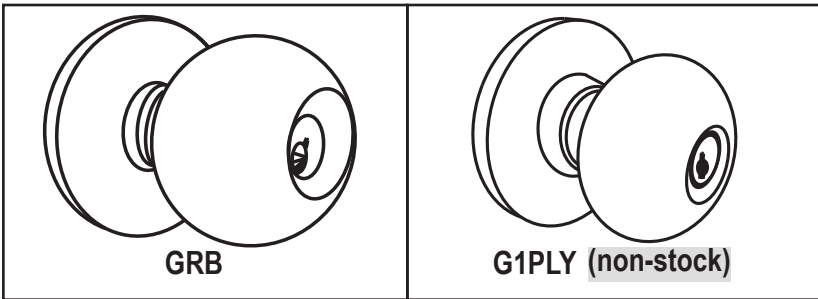

When ordering: "G1PLY" design **Example:** GRB00 Entrance in G1PLY design is G1PLY00

| FUNCTION | ANSI | ITEM # | US32D | US3 | US10B, 10, 4, 26 | PCS / MC |
|---------------------------------|------|--------------------|--|-----|------------------|----------|
| Entrance | F109 | ⌘ GRB00 or ICGRB00 | For pricing & availability inquiries contact your Local Distributor or click here for the list of our Sales Reps | | | 10 |
| Storelock (keyed Dbl. cyl.) | F91 | GRB02 | | | | |
| Classroom | F84 | ⌘ GRB03 or ICGRB03 | | | | |
| Communicating (keyed Dbl. cyl.) | F80 | GRB04 | | | | |
| Storeroom | F86 | ⌘ GRB05 or ICGRB05 | | | | |
| Institution (keyed Dbl. cyl.) | F87 | GRB09 | | | | |
| Privacy | F76 | GRB20 | | | | |
| Passage | F75 | GRB30 | | | | |
| Single Dummy | ---- | GRB40 | | | | |

⌘ (IC) Indicates function available with **Best, Falcon and Arrow** Interchangeable Core.

► **PACKAGING INCLUDES**

UL Listed 2 3/4" Backset, 2 1/4" x 1 1/8" faceplate, Standard "C", 6-pin cylinder, ASA Strike

► **KEYWAYS**

6-pin solid brass "C" keyway standard. Optional: Schlage E, Schlage C-K, Russwin D1-2-3-4, Corbin 59 / 60, Corbin-Russwin L4, Sargent LA-LB-LC, Falcon / Weiser E, Arrow A, Yale 8, Yale GA and Kwikset. Can also accept Medeco, Assa, Kaba and **Cal-Royal HSK** High Security Cylinders.

► **TACTILE / LEAD LINING**

- Lead Lining Part # **LEAD**
- Tactile Part # **TAC**

► **ANTI MICROBIAL COATING**



Available on US32D finish only.
Prefix "ANTB" before **Part #**.

► **ELECTRIFIED**

- Electrified **Part #** **ELEC**
- Specify 12V or 24V, fail safe (EL) or fail secure (EU)

► **ADDITIONAL PARTS FOR OMEGA GRB SERIES**

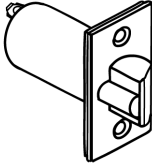
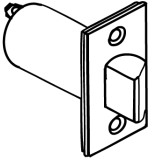
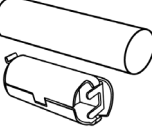
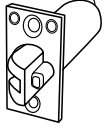
Backsets: UL listed 2 3/8", 2 1/4" x 1 1/8" faceplate

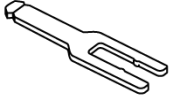
| ILLUSTRATION | ITEM # | DESCRIPTION | FINISH | |
|---|------------|---|------------------------|--|
| EXTRA UL BACKSET | | | | |
|  | CALSLD238 | CAL Series Dead latch 2 3/8" 2 1/4" x 1 1/8" Faceplate | US26D | For pricing & availability inquiries contact your Local Distributor or click here for the list of our Sales Reps |
| | CALDOR238 | CAL101 Dormitory Dead latch 2 3/8" 2 1/4" x 1 1/8" Faceplate | US26D | |
|  | CALSLS238 | CAL Series Spring Latch 2 3/8" 2 1/4" x 1 1/8" Faceplate | US26D | |
| | CALSLP238 | CAL Series Privacy Latch 2 3/8" 2 1/4" x 1 1/8" Faceplate | US26D | |
|  | CAL334 EXT | CAL Series 3 3/4" Extension Link To be used with CALSLD238 | ---- | |
| | CAL5 EXT | CAL Series 5" Extension Link | ---- | |
|  | CAL750 | 2 3/4" Backset, 2 1/4" x 1 1/8" faceplate, 3/4" throw, anti-friction Dead latch for pairs of fire doors | US26D | |
| STRIKES | | | | |
|  | TS | T-Strike | US3, 10B, 26, 10, 4 | For pricing & availability inquiries contact your Local Distributor or click here for the list of our Sales Reps |
| | FLS | Full Lip Strike | | |
| TAIL PIECE | | | | |
|  | ICTP-09 | Tail Piece for ICGRB | ---- | For pricing & availability inquiries contact your Local Distributor or click here for the list of our Sales Reps |

**CAL-ROYAL PRODUCTS, INC.
COMPARISON CHART**

GENESYS "CGN" AND CALYPSO "CAL" SERIES (GRADE 1 CLUTCH LEVER)

| FUNCTION | ANSI # | CAL-ROYAL GENESYS & CALYPSO | SCHLAGE VANDLGARD | SARGENT CLUTCH | RUSSWIN CORBIN | PDQ | FALCON CLUTCH | YALE CLUTCH | HAGER |
|---------------------------------|------------|-----------------------------|-------------------|----------------|----------------|--------------|---------------|-------------|-------------|
| Entrance | F82 / F109 | CGN00, CAL00 | ND53 / ND92PD | 10G05 | CL3351 | GT 116 / 182 | T501 | 5407L | 3450 / 3453 |
| Storeroom | F86 | CGN05, CAL05 | ND80 / ND96PD | 10G04 | CL3357 | GT 115 | T581 | 5405L | 3480 |
| Classroom | F84 | CGN03, CAL03 | ND70S / ND94PD | 10G37 | CL3355 | GT 148 | T561 | 5408L | 3470 |
| Privacy | F76 | CGN20, CAL20 | ND40S | 10U65 | CL3320 | GT 176 | T301 | 5402L | 3440 |
| Passage | F75 | GN30, CAL30 | ND10S | 10U15 | CL3310 | GT 126 | T101 | 5401L | 3410 |
| Dummy | ---- | GN40, CAL40 | ND170 | U94 | CL3350 | GT 211 / 205 | T12 | 455L | 3417 |
| Storelock / Double Cylinder | F91 | GN02, CAL02 | ND66PD | 10G26 | CL3382 | GT 137 | T371 | 5419L | ---- |
| Communication / Double Cylinder | F80 | CGN04, CAL04 | ND72PD | 10G30 | CL3362 | GT 150 | T391 | 5421L | ---- |
| Vestibule | F88 | CGN06, CAL06 | ND60PD | 10G16 | CL3372 | GT 135 | T381 | 5417L | ---- |
| Classroom Intruder | F110 | CGN07, CAL07 | ND75PD | 10G38 | CL3352 | GT 148 | T561 | 5418L | 3495 |
| Institution / Double Cylinder | F87 | CGN09, CAL09 | ND82PD | 10G17 | CL3332 | GT 128 | T411 | 5430L | ---- |
| Exit/Communicating | F89 | GN50 | ND25D | 10G15-3 | CL3380 | GT 125 | ---- | 5428L | ---- |
| Dormitory | F90 | CAL101 | ND73PD | 10G54 | CL3375 | GT 165 | T571 | 5422L | 3473 |

**PIONEER "SL" SERIES, EXPLORER "XP" SERIES (GRADE 2 NON-CLUTCH LEVER)
PIONEER "CSL" SERIES (GRADE 2 CLUTCH LEVER)**

| FUNCTION | ANSI # | CAL-ROYAL PIONEER SERIES | SCHLAGE NON-CLUTCH | SARGENT NON-CLUTCH | RUSSWIN CORBIN | PDQ | FFRNON TUBULAR NON-CLUTCH | YALE | HAGER |
|--------------------------|------------|--------------------------|--------------------|--------------------|----------------|-----------|---------------------------|--------|-------|
| Entrance | F82 / F109 | CSL00 / SL00 | AL53 | 65G05 | CL3851 | SP / SK | W511 | 5307LN | 3553 |
| Storeroom | F109 | SL01 | AL50 | ---- | CL3861 | 116 | W501 | --- | 3550 |
| Classroom | F86 | CSL05 / SL05 | AL80 | 65G04 | CL3857 | 115 | W581 | 5305LN | 3580 |
| Privacy | F84 | CSL03 / SL03 | AL70 | 65G37 | CL3855 | 148 | W561 | 5308LN | 3570 |
| Passage | F76 | SL30 | AL10S | 65U15 | CL3810 | 126 | W101 | 5301LN | 3510 |
| Dummy | ---- | 40SL40 | AL170 | 65U93 | CL3850 | 211 / 205 | W12 | 5355LN | 3517 |
| Exit / Communicating | F89/F111 | SL50 | AL25 | N/A | CL3880 | 125 | W161 | 5328LN | 3525 |
| Exit Communicating Keyed | F112 | SL80 | ---- | ---- | ---- | ---- | ---- | ---- | ---- |
| Patio | F77 | SL10 | ---- | ---- | CL3840 | GP182 | ---- | ---- | ---- |

HIL AND JHIL SERIES (INTERCONNECTED GRADE 2 LEVER)

| FUNCTION | ANSI NO | CAL-ROYAL HIL SERES | SCHLAGE | FALCON | HAGER |
|---------------------------|---------|---------------------|---------|--------|-------|
| Entrance - Single Locking | F95 | HIL30, JHIL30 | CS201 | H2101 | 3710 |
| Entrance - Double Locking | F97 | HIL00, JHIL00 | - | - | 3753 |

Other functions available upon request and subject to minimum quantity: Storeroom, single / double dummy trim



CAL-ROYAL PRODUCTS, INC.

COMPARISON CHART

GRADE 2 CYLINDRICAL LEVER (SG DESIGN)

| FUNCTION | ANSI # | CAL-ROYAL SG SERIES | SCHLAGE S | FALCON "Y" Dane | YALE 4300LN | PDQ SE | CORBIN RUSSWIN | HAGER 3600 |
|-----------|------------|---------------------|-----------|-----------------|-------------|--------|----------------|------------|
| Entrance | F82 / F109 | SG00 | S51PD | Y521 | 4307LN | SE-116 | CL3751 | 3653 |
| Storeroom | F86 | SG05 | S80PD | Y581 | 4305LN | SE-115 | CL3759 | 3680 |
| Classroom | F84 | SG03 | S70PD | Y561 | 4308LN | SE-148 | CL3755 | 3670 |
| Patio | F77 | SG10 | ---- | ---- | ---- | ---- | ---- | ---- |
| Privacy | F76 | SG20 | S40D | Y301 | 4302LN | SE-176 | CL3720 | 3640 |
| Passage | F75 | SG30 | S10D | Y101 | 4301LN | SE-126 | CL3710 | 3610 |
| Dummy | ---- | SG40 | S170 | Y12 | 4355LN | SE-211 | CL3750 | 3617 |
| Exit | F89 | SG50 | ---- | Y161 | ---- | SE-125 | CL3780 | ---- |

GRADE 2 CYLINDRICAL LOCKSET, ORBIT STYLE (BA & PLG DESIGNS)

| FUNCTION | ANSI # | CAL-ROYAL BA SERIES | SCHLAGE A SERIES | CORBIN 5600 | RUSSWIN 3300 | SARGENT 6 LINE | YALE 5300 | ARROW 151 | PDQ SV | FED. NO. |
|-------------|------------|---------------------|------------------|-------------|--------------|----------------|-----------|-----------|--------|----------|
| Entrance | F82 / F109 | BA00 | A53PD | 5651 | CK4251 | 6G05 | 5307 | 151 | SV116 | 160A |
| Privacy | F76-2 | BA20 | A40S | 5620 | CK4220 | 6U65 | ---- | 157 | SV176 | 160L |
| Passage | F75-2 | BA30 | A10S | 5610 | CK4210 | 6U15 | 5301 | 156 | SV126 | 160N |
| Storeroom | F86-2 | BA05 | A80PD | 5657 | CK4257 | 6G04 | 5305 | 151F | SV115 | 160D |
| Classroom | F84-2 | BA03 | A70PD | 5655 | CK4255 | 6G37 | 5308 | 151S | SV148 | 160R |
| Double Cyl | ---- | BA04 | A66D | ---- | CK4262 | ---- | 5316 | ---- | SV137 | ---- |
| Sgl Dummy | F79-2 | BA40 | A170 | ½ DT | CK4250 | 6U93 | 355 | 125 | SV211 | ---- |
| Storage | F91 | BA02 | ---- | ---- | CK4282 | ---- | ---- | ---- | ---- | ---- |
| Institution | F87 | BA09 | ---- | ---- | CK4232 | ---- | ---- | ---- | ---- | ---- |
| Exit | F89 | BA50 | A25D | ---- | ---- | 6G15-3 | 5328 | 156CB | SV125 | ---- |

TUSCANY Series

Clutch Mechanism, Optional Thru Bolt Installation
 ANSI - A156.2, Series 4000, Grade 2

⌘ Optional Interchangeable Core for **Best, Falcon and Arrow**

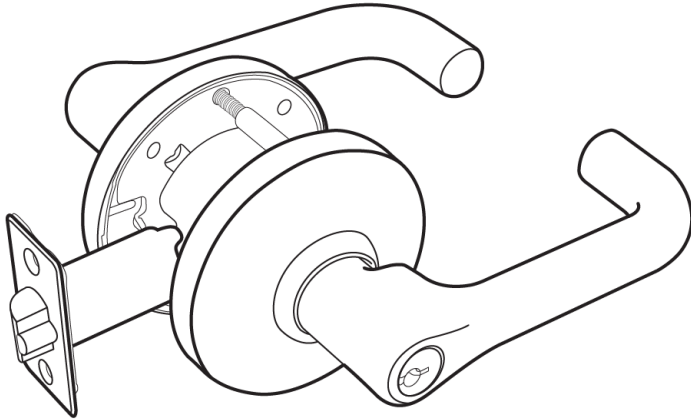



MEETS
The Buy American Act

| FUNCTIONS | ANSI | ITEM # | US26D | US10B | US3 | US10 | US26 | US4 | PCS / MC |
|---------------------------|------|-------------|--|-------|-----|------|------|-----|----------|
| Entrance | F109 | CTUSL00 | For pricing & availability inquiries contact your Local Distributor or click here for the list of our Sales Reps | | | | | | 10 |
| | | ⌘ ICCTUSL00 | | | | | | | |
| Entrance Push Button Lock | F82 | CTUSL01 | | | | | | | |
| Classroom | F84 | CTUSL03 | | | | | | | |
| | | ⌘ ICCTUSL03 | | | | | | | |
| Storeroom | F86 | CTUSL05 | | | | | | | |
| | | ⌘ ICCTUSL05 | | | | | | | |
| Privacy | F76 | CTUSL20 | | | | | | | |
| Passage | F75 | TUSL30 | | | | | | | |
| Exit | F89 | TUSL50 | | | | | | | |
| Single Dummy | ---- | TUSL40 | | | | | | | 20 |

⌘ (IC) Indicates function available with **Best, Falcon and Arrow** Interchangeable Core.

► **ADDITIONAL PARTS OF TUSCANY SERIES**

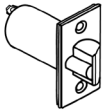
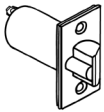
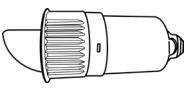
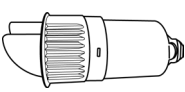
Backsets: UL listed 2 3/8", (2 1/4" x 1") faceplate

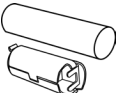
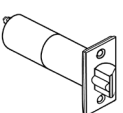
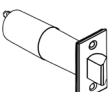
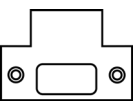
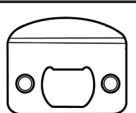
| ILLUSTRATION | ITEM # | DESCRIPTION | FINISH | |
|---|----------|--|------------------------------------|--|
|  | ULSLD238 | SL Series UL-listed Dead Latch 2 3/8" 2 1/4" x 1" Faceplate | US3, 26D, 10B, 10, 26 | For pricing & availability inquiries contact your Local Distributor or click here for the list of our Sales Reps |
|  | ULSLS238 | SL Series UL-listed Spring Latch 2 3/8" 2 1/4" x 1" Faceplate | US26D, 10B, 10, 26 | |
|  | SLDRI-1 | 2 3/4" Entrance, Drive-in Latch bolt for G2 Lockset | ZINC | |
| | SLDRI-2 | 2 3/4" Privacy / Passage, Drive-in Latch bolt for G2 Lockset | | |
|  | SLDRI-4 | 2 3/8" Entrance, Drive-in Latch bolt for G2 Lockset | | |
| | SLDRI-5 | 2 3/8" Privacy / Passage, Drive-in Latch bolt for G2 Lockset | | |
| EXTRA UL LISTED BACKSET | | | | |
|  | ULSLD234 | SL Series Dead Latch 2 3/4" 2 1/4" x 1 1/8" Faceplate | US3, 26D, 10B, 10, 26 | For pricing & availability inquiries contact your Local Distributor or click here for the list of our Sales Reps |
|  | ULSLS234 | SL Series Spring Latch 2 3/4" 2 1/4" x 1 1/8" Faceplate | US3, 26D, 10B, 10, 26 | |
| 3 3/4", 5" UL LISTED BACKSET | | | | |
|  | SL5 | 5" UL listed Extension Link | --- | For pricing & availability inquiries contact your Local Distributor or click here for the list of our Sales Reps |
|  | SLD334 | 3 3/4" Dead latch, 2 1/4" x 1 1/8" Faceplate | US3, 26D, 10B | |
|  | SLS334 | 3 3/4" Spring Latch, 2 1/4" x 1 1/8" Faceplate | US3, 26D, 10B | |
| STRIKES | | | | |
|  | TS | T-Strike | US3, 26D, 10B, 10, 26, 15, 4 | For pricing & availability inquiries contact your Local Distributor or click here for the list of our Sales Reps |
|  | FLS | Full lip strike | US3, 26D, 10B, 10, 26, 15, 4, 5 | |

CRCODE200 Series

GRADE 2, MECHANICAL STAND ALONE PUSH BUTTON LOCK
AND EXIT DEVICE TRIM WITH **BREAKAWAY LEVER FEATURE**

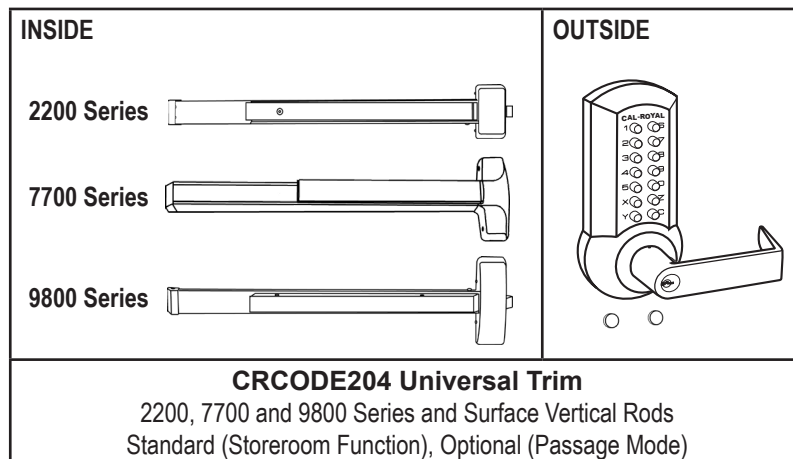
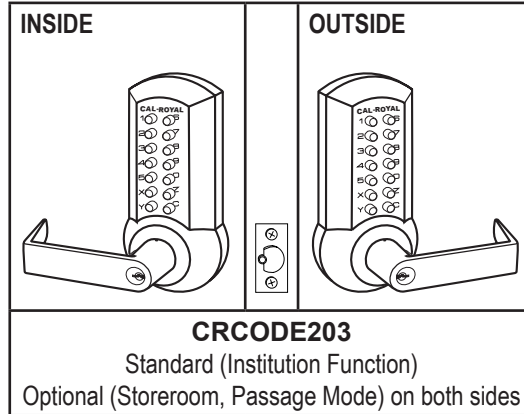
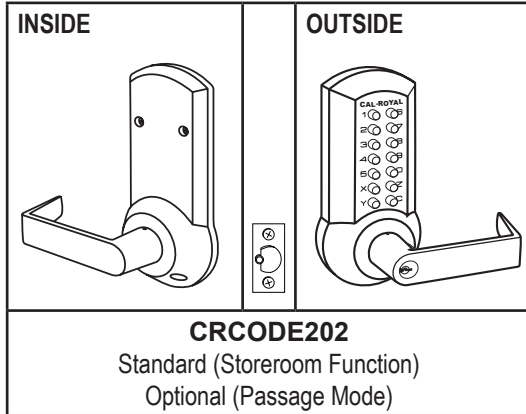

| FUNCTION | ITEM # | US26D | US10B | PCS / MC |
|---|-----------|--|-------|----------|
| Mechanical Easy Code Change Lock with 2 3/4" backset latchbolt Door Thickness: 1 3/8" - 2 1/4" | CRCODE202 | For pricing & availability inquiries contact your Local Distributor or click here for the list of our Sales Reps | | 8 |
| Double Coded Easy Code Change Lock with 2 3/4" backset latchbolt Door Thickness: 1 3/8" - 1 3/4" | CRCODE203 | | | 8 |
| Mechanical Easy Code Change Exit Trim for 2200, 7700 and 9800 Series Exit Device Door Thickness: 1 3/4" - 2" | CRCODE204 | | | 8 |
| ACCESSORIES | | | | |
| CRCODE200 Series Dead latch 2 3/8" 2 1/4" x 1" Faceplate (for CRCODE-202 and 203) | CRSLD | For pricing & availability inquiries contact your Local Distributor or click here for the list of our Sales Reps | --- | 1 |
| Easy Code Change Key | EZCHKEY | BLUE | --- | 1 |

PIONEER SL Series

HEAVY DUTY CYLINDRICAL LEVERSETS

ANSI - A156.2, Series 4000, Grade 2

Optional Interchangeable Core for **Best, Falcon and Arrow**

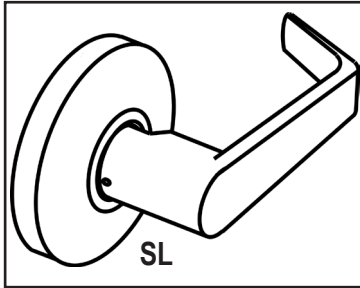

LIFETIME WARRANTY



MEETS
The Buy American Act



| FUNCTIONS | ANSI | ITEM # | US26D | US3 | US10BE, 10, 26, 4, 15, 5 | US1 | PCS / MC |
|---|-----------------|--------------------|-------|-----|--------------------------|-----|----------|
| Entrance | F109 | SL00 ● ICSL00 | | | | | 10 |
| Combination Entrance and Single Cylinder Deadbolt -- KA/2 packed together | NEW ITEM | SL00 / T220 | | | | | |
| Storeroom | F91 | SL05 ● ICSL05 | | | | | |
| Classroom | F84 | SL03 ● ICSL03 | | | | | |
| Entrance Push Button Lock | F82 | SL01 ● ICSL01 | | | | | |
| Exit Lock / Connecting Room with key | ---- | SL80 ● ICSL80 | | | | | |
| Dormitory / Assisted Living | F90 | SL101 ● ICSL101 | | | | | |
| Privacy (see below for split finishes) | F76 | SL20 | | | | | |
| Patio | F77 | SL10 | | | | | |
| Passage | F75 | SL30 | | | | | |
| Exit | F89 | SL50 | | | | | |
| Single Dummy | ---- | SL40 | | | | | |

For pricing & availability inquiries contact your Local Distributor or click [here](#) for the list of our Sales Reps

● (IC) Indicates function available with **Best, Falcon and Arrow** Interchangeable Core.

► SPLIT FINISHES FOR PRIVACY FUNCTION

| ILLUSTRATION | ITEM # | FUNCTIONS | ANSI | | PCS / MC | UNIT |
|--------------|---------------------------|-----------|------|--|----------|------|
| <p>SL20</p> | SL20 US3 / 26 (Inside) | Privacy | F76 | For pricing & availability inquiries contact your Local Distributor or click here for the list of our Sales Reps | 10 | Ea. |
| | SL20 US10B / 26 (Inside) | | | | | |
| | SL20 US4 / 26D (Inside) | | | | | |
| | SL20 US4 / 26 (Inside) | | | | | |
| | SL20 US4 / 3 (Inside) | | | | | |
| | SL20 US3 / 26D (Inside) | | | | | |
| | SL20 US10B / 26D (Inside) | | | | | |

PIONEER RL & AG Series

HEAVY DUTY CYLINDRICAL LEVERSETS

ANSI - A156.2, Series 4000, Grade 2

Optional Interchangeable Core for **Best, Falcon and Arrow**

| | | | |
|---|--------------------------|--|---|
|  | LIFETIME WARRANTY | BHMA CERTIFIED <small>Be Safe. Be Secure. Look for the Mark.</small> | MEETS The Buy American Act |
|---|--------------------------|--|---|

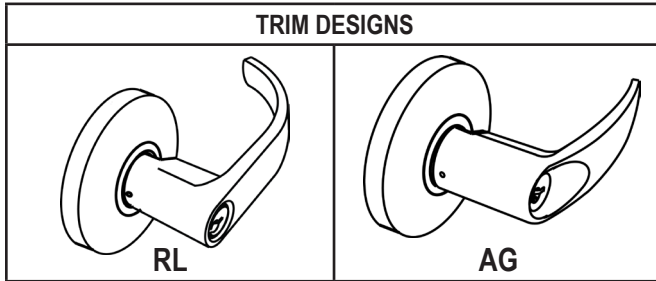

| FUNCTIONS | ANSI | ITEM # | | US26D | US3 | US10BE, 10, 26, 4, 15 | US1 | PCS / MC |
|--|------|----------------------|----------------------|-------|-----|--------------------------|-----|--|
| | | RL | AG | | | | | |
| Entrance | F109 | ● RL00 ● ICRL00 | ● AG00 ● ICAG00 | | | | | For pricing & availability inquiries contact your Local Distributor or click here for the list of our Sales Reps |
| Storeroom | F91 | ● RL05 ● ICRL05 | ● AG05 ● ICAG05 | | | | | |
| Classroom | F84 | ● RL03 ● ICRL03 | ● AG03 ● ICAG03 | | | | | |
| Entrance Push Button Lock | F82 | ● RL01 ● ICRL01 | ● AG01 ● ICAG01 | | | | | |
| Exit Lock / Connecting Room with key | ---- | ● RL80 ● ICRL80 | ● AG80 ● ICAG80 | | | | | |
| Dormitory / Assisted Living | F90 | ● RL101 ● ICRL101 | ● AG101 ● ICAG101 | | | | | |
| Privacy (see below for split finishes) | F76 | RL20 | AG20 | | | | | |
| Patio | F77 | RL10 | AG10 | | | | | |
| Passage | F75 | RL30 | AG30 | | | | | |
| Exit | F89 | RL50 | AG50 | | | | | |
| Single Dummy | ---- | RL40 | AG40 | | | | | 20 |

● (IC) Indicates function available with **Best, Falcon and Arrow** Interchangeable Core.

► SPLIT FINISHES FOR PRIVACY FUNCTION

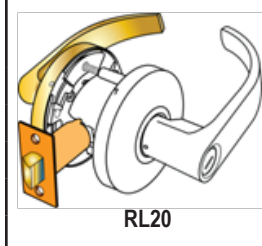
| ILLUSTRATION | ITEM # | FUNCTIONS | ANSI | PCS / MC | UNIT |
|---|-----------------------------------|-----------|------|----------|------|
|  <p>RL20</p> | RL20 or AG20 US3 / 26 (Inside) | Privacy | F76 | 10 | Ea. |
| | RL20 or AG20 US10B / 26 (Inside) | | | | |
| | RL20 or AG20 US4 / 26D (Inside) | | | | |
| | RL20 or AG20 US4 / 26 (Inside) | | | | |
| | RL20 or AG20 US4 / 3 (Inside) | | | | |
| | RL20 or AG20 US3 / 26D (Inside) | | | | |
| | RL20 or AG20 US10B / 26D (Inside) | | | | |

PIONEER CSL, CRL & CAG CLUTCH HEAVY DUTY CYLINDRICAL LEVERSETS WITH CLUTCH ANSI - A156.2, Series 4000, Grade 2

Optional Interchangeable Core for **Best, Falcon and Arrow**



**LIFETIME
WARRANTY**

BHMA
CERTIFIED
Be Safe. Be Secure. Look for the Mark.

MEETS
The Buy American Act

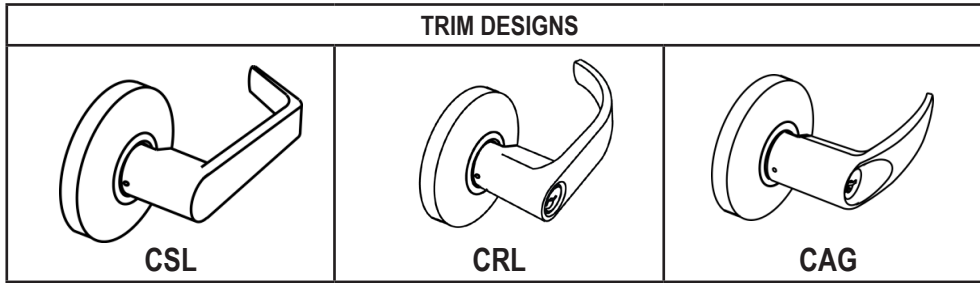
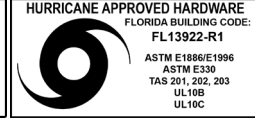

| FUNCTIONS | ANSI | ITEM # | US26D | US3 | US10BE | US10, 26, 4, 15, 5 | PCS / MC |
|-----------|------|-----------|--|-----|--------|--------------------|----------|
| Entrance | F109 | CSL00 | For pricing & availability inquiries contact your Local Distributor or click here for the list of our Sales Reps | | | | 10 |
| | | ● ICCSL00 | | | | | |
| Storeroom | F91 | CSL05 | | | | | |
| | | ● ICCSL05 | | | | | |
| Classroom | F84 | CSL03 | | | | | |
| | | ● ICCSL03 | | | | | |
| Privacy | F76 | CSL20 | | | | | |

| FUNCTIONS | ANSI | ITEM # | | US26D, 3 | US10BE, 10, 26, 4, 15, 5 | PCS / MC |
|-----------|------|-----------|-----------|--|--------------------------|----------|
| Entrance | F109 | CRL00 | CAG00 | For pricing & availability inquiries contact your Local Distributor or click here for the list of our Sales Reps | | 10 |
| | | ● ICCRL00 | ● ICCAG00 | | | |
| Storeroom | F91 | CRL05 | CAG05 | | | |
| | | ● ICCRL05 | ● ICCAG05 | | | |
| Classroom | F84 | CRL03 | CAG03 | | | |
| | | ● ICCRL03 | ● ICCAG03 | | | |
| Privacy | F76 | CRL20 | CAG20 | | | |

● (IC) Indicates function available with **Best, Falcon and Arrow** Interchangeable Core.

► **PACKAGING INCLUDES**

UL Listed 2 3/4" Backset, 2 1/4" x 1 1/8" faceplate ASA Strike

► **KEYWAYS**



6-pin solid brass "C" keyway standard. Optional: Schlage E, Schlage C-K, Russwin D1-2-3-4, Corbin 59 / 60, Arrow A, Corbin-Russwin L4, Sargent LA-LB-LC, Falcon / Weiser E, Yale 8, Yale GA and Kwikset. Can also accept Medeco, Assa, Kaba and **Cal-Royal HSK** High Security Cylinders.

► **TACTILE / LEAD LINING**

Lead Lining Part # **LEAD**
Tactile Part # **TAC**

► **ADDITIONAL PARTS FOR PIONEER SERIES**

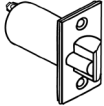
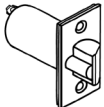
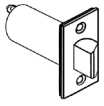
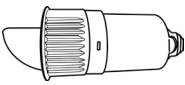
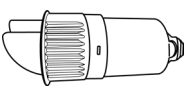
Backsets: UL listed 2 3/8", (2 1/4" x 1") faceplate

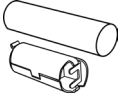
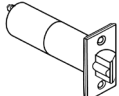
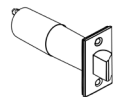
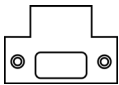
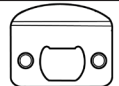
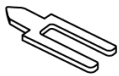
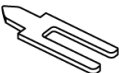
| ILLUSTRATION | ITEM # | DESCRIPTION | FINISH | |
|---|-----------|---|------------------------------------|--|
|  | ULSLD238 | SL Series UL-listed Dead Latch 2 3/8" 2 1/4" x 1" Faceplate | US3, 26D, 10B, 10, 26 | For pricing & availability inquiries contact your Local Distributor or click here for the list of our Sales Reps |
|  | ULSLS238 | SL Series UL-listed Spring Latch 2 3/8" 2 1/4" x 1" Faceplate | US26D, 10B, 10, 26 | |
|  | ULSGPA238 | 2 3/8" UL-listed Dead Latch, 2 1/4" x 1" Faceplate (for SG10, SL10 Patio Function and SL101 Dormitory/Assisted Living Function) | US26D | |
|  | SLDRI-1 | 2 3/4" Entrance, Drive-in Latch bolt for G2 Lockset | ZINC | |
| | SLDRI-2 | 2 3/4" Privacy / Passage, Drive-in Latch bolt for G2 Lockset | | |
|  | SLDRI-4 | 2 3/8" Entrance, Drive-in Latch bolt for G2 Lockset | | |
| | SLDRI-5 | 2 3/8" Privacy / Passage, Drive-in Latch bolt for G2 Lockset | | |
| EXTRA UL LISTED BACKSET | | | | |
|  | ULSLD234 | SL Series Dead Latch 2 3/4" 2 1/4" x 1 1/8" Faceplate | US3, 26D, 10B, 10, 26 | For pricing & availability inquiries contact your Local Distributor or click here for the list of our Sales Reps |
|  | ULSLS234 | SL Series Spring Latch 2 3/4" 2 1/4" x 1 1/8" Faceplate | US3, 26D, 10B, 10, 26 | |
| 3 3/4", 5" UL LISTED BACKSET | | | | |
|  | SL5 | 5" UL listed Extension Link | ---- | For pricing & availability inquiries contact your Local Distributor or click here for the list of our Sales Reps |
|  | SLD334 | 3 3/4" Dead latch, 2 1/4" x 1 1/8" Faceplate | US3, 26D, 10B | |
|  | SLS334 | 3 3/4" Spring Latch, 2 1/4" x 1 1/8" Faceplate | US3, 26D, 10B | |
| STRIKES | | | | |
|  | TS | T-Strike | US3, 26D, 10B, 10, 26, 15, 4 | For pricing & availability inquiries contact your Local Distributor or click here for the list of our Sales Reps |
|  | FLS | Full lip strike | US3, 26D, 10B, 10, 26, 15, 4, 5 | |
| TAIL PIECE | | | | |
|  | ICTP-03 | 6-pin Tail Piece for IC Pioneer Series | ---- | For pricing & availability inquiries contact your Local Distributor or click here for the list of our Sales Reps |
|  | ICTP-04 | 7 Pin Tail Piece for IC Pioneer Series | | |

COMMANDER COM (CLUTCH) Series

HEAVY DUTY CYLINDRICAL LEVERSETS WITH CLUTCH

ANSI - A156.2, Series 4000, Grade 2

With Interchangeable Core to accept **Schlage Full Size** format OEM Interchangeable Core Cylinder

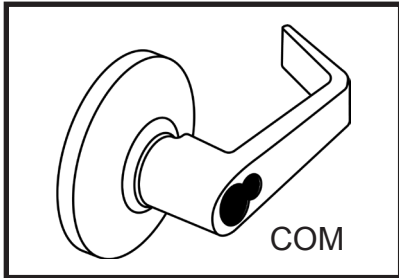

LIFETIME WARRANTY

MEETS
The Buy American Act

| FUNCTIONS | ANSI | ITEM # | US26D, 3 | US10B | US10, 26, 4, 5 | PCS / MC |
|-----------|------|---------|--|-------|----------------|----------|
| Entrance | F109 | ICCOM00 | For pricing & availability inquiries contact your Local Distributor or click here for the list of our Sales Reps | | | 10 |
| Storeroom | F86 | ICCOM05 | | | | |
| Classroom | F84 | ICCOM03 | | | | |

***Use SL Pioneer series lockset for interior locks.

► PACKAGING INCLUDES



- UL Listed 2 3/4" Backset, 2 1/4" x 1 1/8" faceplate
- Less cylinder
- ASA Strike

► TACTILE / LEAD LINING

- Lead Lining Part # LEAD
- Tactile Part # TAC

► ADDITIONAL PARTS

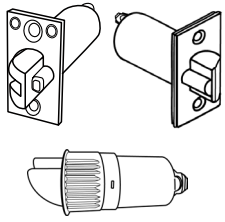
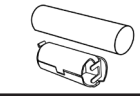
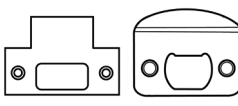
Backsets: UL listed 2 3/8", 2 1/4" x 1 1/8" Faceplate

| ILLUSTRATION | ITEM # | DESCRIPTION | FINISH | |
|---|-----------------|--|--------------------------|--|
|  | GND238 | CGN Series UL-listed Dead Latch 2 3/8" | US3, 26D, 10B, 26 | For pricing & availability inquiries contact your Local Distributor or click here for the list of our Sales Reps |
| | GND750 | 2 3/4" x 1 1/8" x 3/4" throw, anti-friction Dead latch for pairs of fire doors | US3, 26D, 10B, 10 | |
| | SLDRI-1 | 2 3/4" Entrance, Drive-in Latch bolt for G2 Lockset | ZINC | |
| | SLDRI-4 | 2 3/8" Entrance, Drive-in Latch bolt for G2 Lockset | ZINC | |
| ♦ EXTRA UL LISTED BACKSET | | | | |
|  | GND234 | CGN Series Dead Latch 2 3/4" | US3, 26D, 10B, 26 | For pricing & availability inquiries contact your Local Distributor or click here for the list of our Sales Reps |
| | GEN5 EXT | 5" Backset Extension Link | ---- | |
|  | STRIKES | | | |
| | TS | T-Strike | US3, 26D, 10B, 26, 10, 4 | For pricing & availability inquiries contact your Local Distributor or click here for the list of our Sales Reps |
| FLS | Full lip strike | US3, 26D, 10B, 26, 10, 4, 5 | | |
| TAIL PIECE | | | | |
|  | ICTP07 | Tail piece for Schlage Large format IC Core | ---- | For pricing & availability inquiries contact your Local Distributor or click here for the list of our Sales Reps |

EXPLORER XP Series

HEAVY DUTY CYLINDRICAL LEVERSETS

ANSI - A156.2, Series 4000, Grade 2

Optional Interchangeable Core for **Best, Falcon and Arrow**

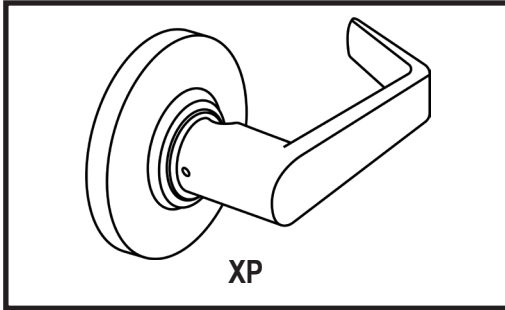

| | | | |
|---|--------------------------|--|--------------------------------------|
| 3 HOUR FIRE RATED UL10C, UBC7-2-1997 | LIFETIME WARRANTY | BHMA CERTIFIED Be Safe. Be Secure. Look for the Mark. | MEETS The Buy American Act |
|---|--------------------------|--|--------------------------------------|

| ANSI | FUNCTIONS | ITEM # | US26D | US3 | US10B, 10, 26, 4 | US5,15 | PCS / MC | | | | |
|------|---|------------------|--|-----|------------------|--------|----------|----|--|--|--|
| F109 | Entrance | XP00 ● ICXP00 | For pricing & availability inquiries contact your Local Distributor or click here for the list of our Sales Reps | | | | 10 | | | | |
| F91 | Storeroom | XP05 ● ICXP05 | | | | | | | | | |
| F84 | Classroom | XP03 ● ICXP03 | | | | | | | | | |
| F76 | Privacy (See below for split finishes) | XP20 | | | | | | | | | |
| --- | Hospital Privacy | HXP20 | | | | | | | | | |
| F75 | Passage | XP30 | | | | | | | | | |
| F89 | Exit | XP50 | | | | | | | | | |
| ---- | Single Dummy | XP40 | | | | | | | | | |
| | | | | | | | | 20 | | | |

● (IC) Indicates function available with **Best, Falcon and Arrow** Interchangeable Core.

◆ SPLIT FINISHES FOR PRIVACY FUNCTION

| ILLUSTRATION | ITEM # | FUNCTIONS | ANSI | FINISH | PCS / MC |
|--------------|--------|-----------|------|---------------------|--|
| | XP20 | Privacy | F76 | US3 / 26D (Inside) | For pricing & availability inquiries contact your Local Distributor or click here for the list of our Sales Reps |
| | | | | US4 / 26 (Inside) | |
| | | | | US10B / 26 (Inside) | |
| | | | | US4 / 26D (Inside) | |
| | | | | | 10 |

EXPLORER XPRL Series

HEAVY DUTY CYLINDRICAL LEVERSETS

ANSI - A156.2, SERIES 4000, GRADE 2

● Optional Interchangeable Core for **Best, Falcon and Arrow**

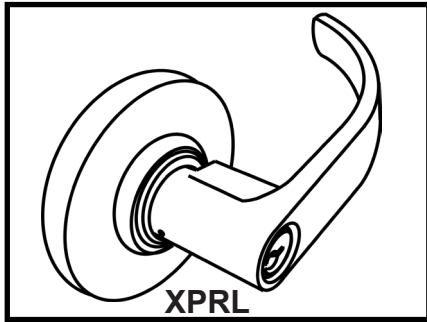

LIFETIME WARRANTY

BHMA™ CERTIFIED
Be Safe. Be Secure. Look for the Mark.

MEETS
The Buy American Act

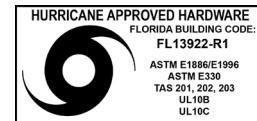

| FUNCTIONS | ANSI | ITEM # | US26D | US10B | US3 | US10,4 26,15 | PCS / MC |
|---|------|------------|--|-------|-----|-----------------|-------------|
| Entrance | F109 | XPRL00 | For pricing & availability inquiries contact your Local Distributor or click here for the list of our Sales Reps | | | | 10 |
| | | ● ICXPRL00 | | | | | |
| Storeroom | F91 | XPRL05 | | | | | |
| | | ● ICXPRL05 | | | | | |
| Classroom | F84 | XPRL03 | | | | | |
| | | ● ICXPRL03 | | | | | |
| Privacy (See below for split finishes) | F76 | XPRL20 | | | | | |
| Hospital Privacy | --- | HXPRL20 | | | | | |
| Passage | F75 | XPRL30 | | | | | |
| Exit | F89 | XPRL50 | | | | | |
| Single Dummy | ---- | XPRL40 | | | | | 20 |

● (IC) Indicates function available with **Best, Falcon and Arrow** Interchangeable Core.

◆ SPLIT FINISHES FOR PRIVACY FUNCTION

| ILLUSTRATION | ITEM # | FUNCTIONS | ANSI | FINISH | PCS / MC |
|--------------|--------|-----------|------|---------------------|--|
| | XPRL20 | Privacy | F76 | US3 / 26D (Inside) | For pricing & availability inquiries contact your Local Distributor or click here for the list of our Sales Reps |
| | | | | US4 / 26 (Inside) | |
| | | | | US10B / 26 (Inside) | |
| | | | | US4 / 26D (Inside) | |
| | | | | | 10 |

EXPLORER CXP, CXPRL CLUTCH

HEAVY DUTY CYLINDRICAL LEVERSETS WITH CLUTCH

ANSI - A156.2, Series 4000, Grade 2

⚙️ Optional Interchangeable Core for **Best, Falcon and Arrow**

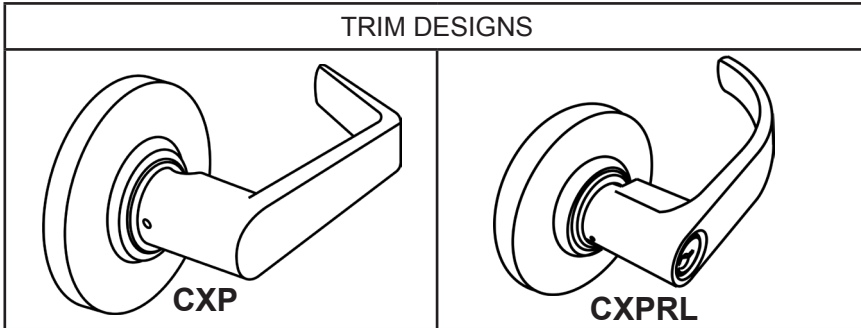

MEETS
The Buy American Act

| FUNCTIONS | ANSI | ITEM # | US26D | US10B | US3 | US10, 26, 4, 15, 5 | PCS / MC |
|------------------|------|------------|--|-------|-----|--------------------|----------|
| Entrance | F109 | CXP00 | For pricing & availability inquiries contact your Local Distributor or click here for the list of our Sales Reps | | | | 10 |
| | | ⚙️ ICCXP00 | | | | | |
| Storeroom | F91 | CXP05 | | | | | |
| | | ⚙️ ICCXP05 | | | | | |
| Classroom | F84 | CXP03 | | | | | |
| | | ⚙️ ICCXP03 | | | | | |
| Privacy | F76 | CXP20 | | | | | |
| Hospital Privacy | --- | HCXP20 | | | | | |

| FUNCTIONS | ANSI | ITEM # | US26D | US10B | US3 | US10, 26, 4, 15, 5 | PCS / MC |
|------------------|------|--------------|--|-------|-----|--------------------|----------|
| Entrance | F109 | CXPRL00 | For pricing & availability inquiries contact your Local Distributor or click here for the list of our Sales Reps | | | | 10 |
| | | ⚙️ ICCXPRL00 | | | | | |
| Storeroom | F91 | CXPRL05 | | | | | |
| | | ⚙️ ICCXPRL05 | | | | | |
| Classroom | F84 | CXPRL03 | | | | | |
| | | ⚙️ ICCXPRL03 | | | | | |
| Privacy | F76 | CXPRL20 | | | | | |
| Hospital Privacy | --- | HCXPRL20 | | | | | |

⚙️ (IC) Indicates function available with **Best, Falcon and Arrow** Interchangeable Core.

► **PACKAGING INCLUDES**

- UL Listed 2 3/4" Backset with 2 1/4" x 1" Faceplate, Square corner, packed with 1/8" Filler for 1 1/8" width
- Standard "C", 6-pin cylinder
- ASA Strike

► **TACTILE / LEAD LINING**

Lead Lining Part # **LEAD**
Tactile Part # **TAC**

► **MOUNT**





2 hole wooden mount
Part # **SLMOUNT**

► **KEYWAYS**

6-pin solid brass "C" keyway standard. Optional: Schlage E, Schlage C-K, Russwin D1-2-3-4, Corbin 59 / 60, Corbin-Russwin L4, Sargent LA-LB-LC, Falcon / Weiser E, Arrow A, Yale 8, Yale GA and Kwikset. Can also accept Medeco, Assa, Kaba and **Cal-Royal HSK** High Security Cylinders.

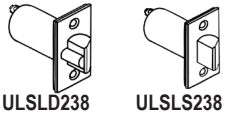
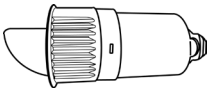
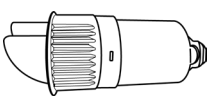
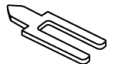
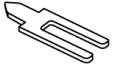
► **ADDITIONAL PARTS FOR EXPLORER SERIES**

Backsets: UL listed 2 3/8", (2 1/4" x 1") faceplate.

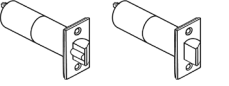
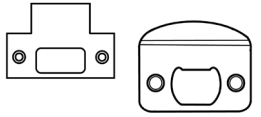
| ILLUSTRATION | ITEM# | DESCRIPTION | FINISH | | |
|--|------------|--|---------------------------------------|--|--|
|  ULSLD238 ULSLS238 | ULSLD238 | XP Series UL-listed Dead Latch 2 3/8" 2 1/4" x 1" Faceplate | US3, 26D, 10B, 10, 26 | For pricing & availability inquiries contact your Local Distributor or click here for the list of our Sales Reps | |
| | ULSLS238 | XP Series UL-listed Spring Latch 2 3/8" 2 1/4" x 1" Faceplate | | | US3, 26D, 10B, 10, 26 |
|  | SLDRI-1 | 2 3/4" Entrance, Drive-in Latch bolt for G2 Lockset | ZINC | | |
| | SLDRI-2 | 2 3/4" Privacy / Passage, Drive-in Latch bolt for G2 Lockset | | | |
|  | SLDRI-4 | 2 3/8" Entrance, Drive-in Latch bolt for G2 Lockset | | | |
| | SLDRI-5 | 2 3/8" Privacy / Passage, Drive-in Latch bolt for G2 Lockset | | | |
| TAIL | | | | | |
|  | ICTP-03 | 6-pin Tail Piece for IC Explorer Series | ---- | | For pricing & availability inquiries contact your Local Distributor or click here for the list of our Sales Reps |
|  | ICTP-04 | 7 Pin Tail Piece for IC Explorer Series | | | |
|  | ICTP-05 | 6-pin Tail Piece for ICXP03 Explorer Series Classroom Function Only | | | |
|  | ICTP-06 | 7 Pin Tail Piece for ICXP03 Explorer Series Classroom Function Only | | | |
| EXTRA UL LISTED BACKSET | | | | | |
|  UL-HIL234 UL-SHIL234 | UL-HIL234 | XP Series Dead Latch 2 3/4" 2 1/4" x 1 1/8" Faceplate | US3, 26D, 10B, 10, 26 | For pricing & availability inquiries contact your Local Distributor or click here for the list of our Sales Reps | |
| | UL-SHIL234 | XP Series Spring Latch 2 3/4" 2 1/4" x 1" Faceplate | | | US3, 26D, 10B, 10, 26 |
| 3 3/4", 5" UL LISTED BACKSET | | | | | |
|  | SL5 | 5" UL listed Extension Link | ---- | For pricing & availability inquiries contact your Local Distributor or click here for the list of our Sales Reps | |
|  | SLD334 | 3 3/4" Dead latch, 2 1/4" x 1 1/8" Faceplate | US3, 26D, 10B | | |
| | SLS334 | 3 3/4" Spring Latch, 2 1/4" x 1 1/8" Faceplate | US3, 26D, 10B | | |
| STRIKES | | | | | |
|  | TS | T-Strike | US3, 4, 26D, 26 10B, 10, 15 | For pricing & availability inquiries contact your Local Distributor or click here for the list of our Sales Reps | |
| | FLS | Full lip strike | US3, 4, 26D, 10B, 10, 15, 26, 5 | | |

CHALLENGER Series

STANDARD DUTY CYLINDRICAL LEVERSETS

ANSI STANDARD A156.2, GRADE 2

● Optional Interchangeable Core for **Best, Falcon and Arrow**

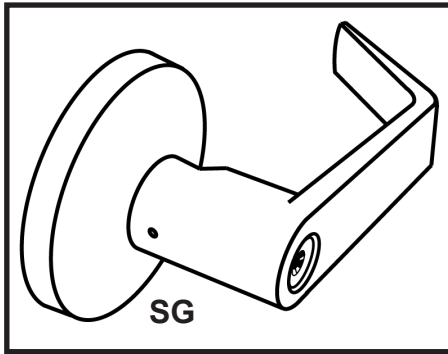

| FUNCTIONS | ANSI | ITEM # | US26D | US3 | US10B, 26 | US15 | US10, 4, 15A | PCS / MC |
|---------------------------|------|----------|--|-----|-----------|------|--------------|----------|
| Entrance | F109 | SG00 | For pricing & availability inquiries contact your Local Distributor or click here for the list of our Sales Reps | | | | | 10 |
| | | ● ICSG00 | | | | | | |
| Entrance Push Button Lock | F82 | SG01 | | | | | | |
| Storeroom | F91 | SG05 | | | | | | |
| | | ● ICSG05 | | | | | | |
| Classroom | F84 | SG03 | | | | | | |
| | | ● ICSG03 | | | | | | |
| Patio | F77 | SG10 | | | | | | |
| Privacy | F76 | SG20 | | | | | | |
| Passage | F75 | SG30 | | | | | | |
| Exit | F89 | SG50 | | | | | | |
| Single Dummy | ---- | SG40 | | | | | | |

● (IC) Indicates function available with **Best, Falcon and Arrow** Interchangeable Core.

STANDARD DUTY CYLINDRICAL LEVERSETS ANSI STANDARD A156.2, GRADE 2

Ⓢ Optional Interchangeable Core for **Best, Falcon and Arrow**

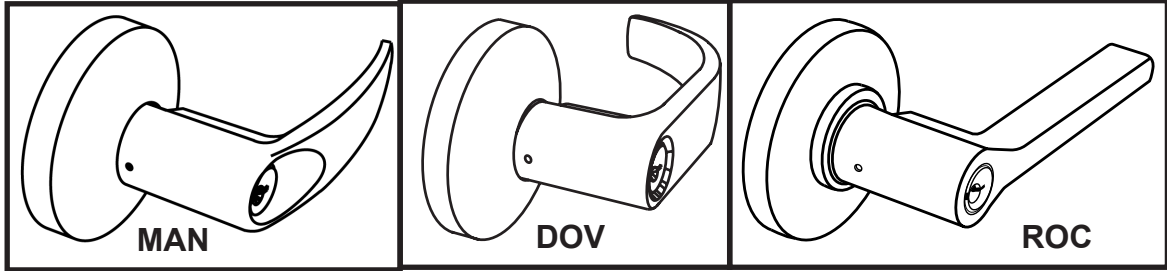

| FUNCTIONS | ANSI | ITEM # | US26D | US3 | US10B, 26, 15, 15A, 4 | PCS / MC |
|--------------|------|------------------------------|--|-----|-----------------------|----------|
| Entrance | F109 | MAN00 / DOV00 / ROC00 | For pricing & availability inquiries contact your Local Distributor or click here for the list of our Sales Reps | | | 10 |
| | | ⓈICMAN00 / ICDOV00 / ICROC00 | | | | |
| Storeroom | F91 | MAN05 / DOV05 / ROC05 | | | | |
| | | ⓈICMAN05 / ICDOV05 / ICROC05 | | | | |
| Classroom | F84 | MAN03 / DOV03 / ROC03 | | | | |
| | | ⓈICMAN03 / ICDOV03 / ICROC03 | | | | |
| Patio | F77 | MAN10 / DOV10 / ROC10 | | | | |
| Privacy | F76 | MAN20 / DOV20 / ROC20 | | | | |
| Passage | F75 | MAN30 / DOV30 / ROC30 | | | | |
| Exit | F89 | MAN50 / DOV50 / ROC50 | | | | |
| Single Dummy | --- | MAN40 / DOV40 / ROC40 | | | | 20 |

Ⓢ (IC) Indicates function available with **Best, Falcon and Arrow** Interchangeable Core.

STANDARD DUTY CYLINDRICAL LEVERSETS
ANSI STANDARD A156.2, GRADE 2

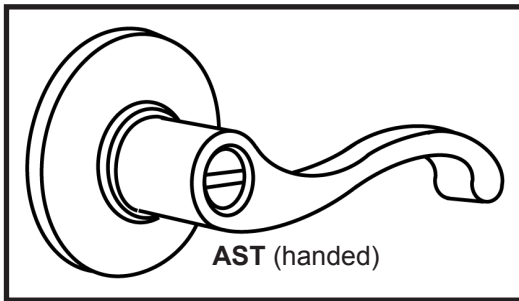

| FUNCTIONS | ANSI | ITEM # | US3 | US15, 15A | US26D | US10B, 26 | PCS / MC |
|--------------|------|--------|--|-----------|-------|-----------|----------|
| Entrance | F109 | AST00 | For pricing & availability inquiries contact your Local Distributor or click here for the list of our Sales Reps | | | | 10 |
| Storeroom | F91 | AST05 | | | | | |
| Classroom | F84 | AST03 | | | | | |
| Privacy | F75 | AST20 | | | | | |
| Passage | F75 | AST30 | | | | | |
| Exit | F89 | AST50 | | | | | |
| Single Dummy | ---- | AST40 | | | | | |

*SH SPECIFY HANDING FOR "AST" Design.

*HANDING: Entrance, Privacy and Passage functions are reversible non handed on AST designs. Specify handing for convenience. If handing is not available at time of shipment, opposite hand will be shipped. Other functions are handed.

► **PACKAGING INCLUDES**

- UL Listed 2 3/4" backset (2 1/4" x 1", square corner packed with 1/8" filler for 1 1/8" width). 2 3/8" available on request.
- Standard "C", 6-pin cylinder
- All locksets are packed with ASA Strike

► **MOUNT**





2 hole wooden mount

► **KEYWAYS**

6-pin solid brass "C" keyway standard. Optional: Schlage E, Schlage C-K, Russwin D1-2-3-4, Corbin 59 / 60, Arrow A, Corbin-Russwin L4, Sargent LA-LB-LC, Falcon / Weiser E, Yale 8, Yale GA and Kwikset. Can also accept Medeco, Assa, Kaba and **Cal-Royal HSK** High Security Cylinders.

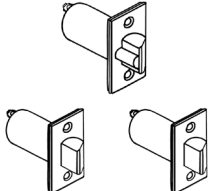
► **ADDITIONAL PARTS FOR CHALLENGER SERIES**

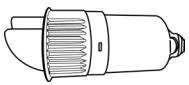
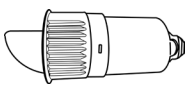
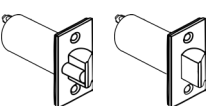
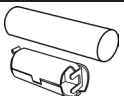
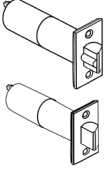
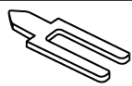
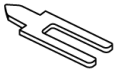
Backsets: UL listed 2 3/8", (2 1/4" x 1") faceplate

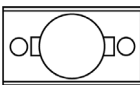
| ILLUSTRATION | ITEM # | DESCRIPTION | FINISH | |
|---|------------|---|-----------------------------------|--|
|  | UL-HIL238 | 2 3/8" UL-listed Dead latch, 2 1/4" x 1" Faceplate (key functions only) | US3, 26D, 10B, 10, 26 | For pricing & availability inquiries contact your Local Distributor or click here for the list of our Sales Reps |
| | UL-SLS238 | 2 3/8" UL-listed Spring Latch, 2 1/4" x 1" Faceplate (for privacy only) | US3, 26D, 10B, 10, 26 | |
| | UL-SHIL238 | 2 3/8" UL-listed Spring Latch, 2 1/4" x 1" Faceplate (for passage only) | US3, 26D, 10B, 10, 26 | |
|  | UL-SGPA238 | 2 3/8" UL-listed Dead Latch, 2 1/4" x 1" Faceplate (for SG10, SL10 Patio Function and SL101 Dormitory/Assisted Living Function) | US26D | |
|  | SLDRI-1 | 2 3/4" Entrance, Drive-in Latch bolt for G2 Lockset | ZINC | |
| | SLDRI-4 | 2 3/8" Entrance, Drive-in Latch bolt for G2 Lockset | ZINC | |
|  | SLDRI-2 | 2 3/4" Privacy / Passage, Drive-in Latch bolt for G2 Lockset | ZINC | |
| | SLDRI-5 | 2 3/8" Privacy / Passage, Drive-in Latch bolt for G2 Lockset | ZINC | |
| EXTRA UL LISTED BACKSET | | | | |
|  | UL-HIL234 | Dead Latch 2 3/4" 2 1/4" x 1 1/8" Faceplate | US3, 26D, 10B, 10, 26 | For pricing & availability inquiries contact your Local Distributor or click here for the list of our Sales Reps |
| | UL-SHIL234 | Spring Latch 2 3/4" 2 1/4" x 1" Faceplate | US3, 26D, 10B, 10, 26 | |
| 3 3/4", 5" UL LISTED BACKSET | | | | |
|  | SL5 | 5" UL listed Extension Link | --- | For pricing & availability inquiries contact your Local Distributor or click here for the list of our Sales Reps |
|  | SLD334 | 3 3/4" Dead latch, 2 1/4" x 1 1/8" Faceplate | US3, 26D, 10B | |
| | SLS334 | 3 3/4" Spring Latch, 2 1/4" x 1 1/8" Faceplate | US3, 26D, 10B | |
| TAIL PIECE | | | | |
|  | ICTP-03 | 6-pin Tail Piece for IC Challenger Series | --- | For pricing & availability inquiries contact your Local Distributor or click here for the list of our Sales Reps |
|  | ICTP-04 | 7-Pin Tail Piece for IC Challenger Series | | |
| STRIKES | | | | |
|  | TS | T strike | US3, 26D, 10B, 10, 15, 26, 4 | For pricing & availability inquiries contact your Local Distributor or click here for the list of our Sales Reps |
| | FLS | Full lip strike | US3, 26D, 10B, 10, 15, 26, 4, 15A | |
|  | LFA18 | Latch front adapter to convert 1" faceplate to 1 1/8" wide door preparation | CLEAR | |

BARRINGTON BA Series

STANDARD DUTY CYLINDRICAL LOCKSETS

ANSI A156.2 Series 4000 Grade 2

Optional Interchangeable Core for **Best, Falcon and Arrow**

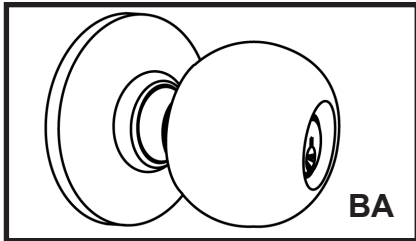

| | | |
|--|------------------------------|---|
|  <small>3 HOUR FIRE RATED UL10C, UBC7-2-1997</small> | LIFETIME WARRANTY | MEETS <i>The Buy American Act</i> |
|--|------------------------------|---|

| Made in Korea | | | | | | | | |
|---|----------|-------------|--|-------|-----|------|---------|----------|
| FUNCTION | ANSI | ITEM # | US32D | US10B | US3 | US10 | US4, 26 | PCS / MC |
| Entrance *****KA/4 | F109 | BA00 | For pricing & availability inquiries contact your Local Distributor or click here for the list of our Sales Reps | | | | | 20 |
| | | ● ICBA00 | | | | | | |
| Combination Entrance and Single Cylinder Deadbolt -- KA / 2 packed together | NEW ITEM | BA00 / T220 | | | | | | |
| | | BA03 | | | | | | |
| Classroom | F84 | ● ICBA03 | | | | | | |
| | | BA05 | | | | | | |
| Storeroom | F86 | ● ICBA05 | | | | | | |
| | | BA04 | | | | | | |
| Communicating | F80 | BA09 | | | | | | |
| Institution | F87 | BA20 | | | | | | |
| Privacy | F76 | BA30 | | | | | | |
| Passage | F75 | BA50 | | | | | | |
| Exit | F89 | BA40 | | | | | | |
| Single Dummy | ---- | | 50 | | | | | |
| Made in Taiwan | | | | | | | | |
| FUNCTION | ANSI | ITEM # | US32D | US10B | US3 | US10 | US4, 26 | PCS / MC |
| Entrance *****KA / 4 | F109 | TBA00 | For pricing & availability inquiries contact your Local Distributor or click here for the list of our Sales Reps | | | | | 20 |
| | | ● ICTBA00 | | | | | | |
| Classroom | F84 | TBA03 | | | | | | |
| | | ● ICTBA03 | | | | | | |
| Storeroom | F86 | TBA05 | | | | | | |
| | | ● ICTBA05 | | | | | | |
| Storelock | F91 | TBA02 | | | | | | |
| Communicating | F80 | TBA04 | | | | | | |
| Institution | F87 | TBA09 | | | | | | |
| Privacy | F76 | TBA20 | | | | | | |
| Passage | F75 | TBA30 | | | | | | |
| Exit | F89 | TBA50 | | | | | | |
| Single Dummy | ---- | TBA40 | | | | | | |

● (IC) Indicates function available with **Best, Falcon and Arrow** Interchangeable Core.

POLYGON PLG Series

STANDARD DUTY CYLINDRICAL LOCKSETS

ANSI A156.2 Series 4000 Grade 2

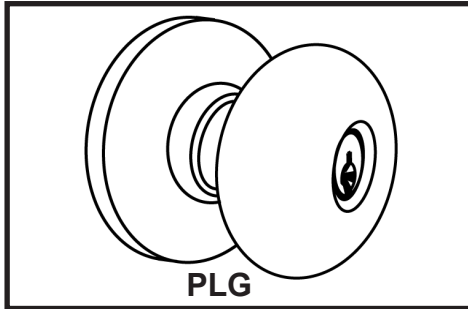

| FUNCTION | ANSI | ITEM # | US32D | US3, 10B | US4, 10 | PCS / MC |
|----------------------|------|--------|--|----------|---------|----------|
| Entrance *****KA / 4 | F109 | PLG00 | For pricing & availability inquiries contact your Local Distributor or click here for the list of our Sales Reps | | | 20 |
| Classroom | F91 | PLG03 | | | | |
| Storeroom | F84 | PLG05 | | | | |
| Storelock | F91 | PLG02 | | | | |
| Communicating | F80 | PLG04 | | | | |
| Institution | F87 | PLG09 | | | | |
| Privacy | F76 | PLG20 | | | | |
| Passage | F75 | PLG30 | | | | |
| Exit | F89 | PLG50 | | | | |
| Single Dummy | ---- | PLG40 | | | | |

► **PACKAGING INCLUDES**

- UL Listed 2 3/4" Backset (2 1/4"x 1 1/8" faceplate)
- Standard "C", 6-pin cylinder
- ASA Strike

► **TACTILE / LEAD LINING**







- Lead Lining Part # **LEAD**
- Tactile Part # **TAC**

► **KEYWAYS**

6-pin solid brass "C" keyway standard. Optional: Schlage E, Schlage C-K, Russwin D1-2-3-4, Corbin 59 / 60, Corbin-Russwin L4, Sargent LA-LB-LC, Falcon / Weiser E, Arrow A, Yale 8, Yale GA and Kwikset. Can also accept Medeco, Assa, Kaba and **Cal-Royal HSK** High Security Cylinders.

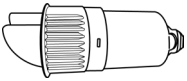
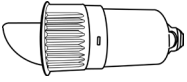
► **ADDITIONAL PARTS FOR BARRINGTON AND POLYGON SERIES**

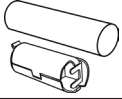
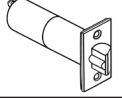
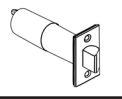
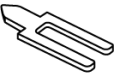
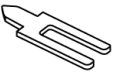
Backsets: UL listed 2 3/8", (2 1/4" x 1") faceplate

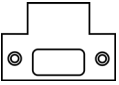
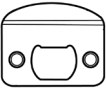
| ILLUSTRATION | ITEM # | DESCRIPTION | FINISH | |
|---|----------|--|------------------------------|--|
|  | ULSLD238 | BA Series UL-listed Dead Latch 2 3/8" PLG Series UL-listed Dead Latch 2 3/8" 2 1/4" x 1" Faceplate | US3, 32D, 10B | For pricing & availability inquiries contact your Local Distributor or click here for the list of our Sales Reps |
|  | ULSLS238 | BA Series UL-listed Spring Latch 2 3/8" PLG Series UL-listed Spring Latch 2 3/8" 2 1/4" x 1" Faceplate | US3, 32D, 10B | |
|  | SLDRI-1 | 2 3/4" Entrance, Drive-in Latch bolt for G2 Lockset | ZINC | |
| | SLDRI-4 | 2 3/8" Entrance, Drive-in Latch bolt for G2 Lockset | ZINC | |
|  | SLDRI-2 | 2 3/4" Privacy / Passage, Drive-in Latch bolt for G2 Lockset | ZINC | |
| | SLDRI-5 | 2 3/8" Privacy / Passage, Drive-in Latch bolt for G2 Lockset | ZINC | |
| EXTRA UL LISTED BACKSET | | | | |
|  | ULSLD234 | Dead Latch 2 3/4" 2 1/4" x 1 1/8" Faceplate | US3, 26D, 10B, 10, 26 | For pricing & availability inquiries contact your Local Distributor or click here for the list of our Sales Reps |
|  | ULSLS234 | Spring Latch 2 3/4" 2 1/4" x 1 1/8" Faceplate | US3, 26D, 10B, 10, 26 | |
| 3 3/4", 5" UL LISTED BACKSET | | | | |
|  | SL5 | 5" UL listed Extension Link | --- | For pricing & availability inquiries contact your Local Distributor or click here for the list of our Sales Reps |
|  | SLD334 | BA Series 3 3/4" Dead latch PLG Series 3 3/4" Dead latch 2 1/4" x 1 1/8" Faceplate | US3, 26D, 10B | |
|  | SLS334 | BA Series 3 3/4" Spring Latch PLG Series 3 3/4" Spring Latch 2 1/4" x 1 1/8" Faceplate | US3, 26D, 10B | |
| TAIL PIECE | | | | |
|  | ICTP-03 | 6-pin Tail Piece for ICBA Series | ---- | For pricing & availability inquiries contact your Local Distributor or click here for the list of our Sales Reps |
|  | ICTP-04 | 7 Pin Tail Piece for ICBA Series | | |
|  | ICTP-08 | Tail Piece for ICTBA Only | | |
| STRIKES | | | | |
|  | TS | T-Strike | US3, 26D, 10B, 10, 15, 26, 4 | For pricing & availability inquiries contact your Local Distributor or click here for the list of our Sales Reps |
|  | FLS | Full Lip Strike | | |

COLUMBUS Series

ANSI A156.2 GRADE 3 CYLINDRICAL LOCKSET, ORBIT STYLE

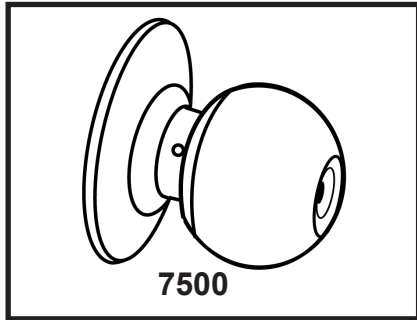

**LIFETIME
WARRANTY**

| FUNCTION | ANSI | ITEM # | US32D | US3,5 | US10B | US4, 10, 15, 15A | PCS / MC |
|-----------------|------|--------|--|-------|-------|------------------|----------|
| Entrance KA / 4 | F109 | 7500 | For pricing & availability inquiries contact your Local Distributor or click here for the list of our Sales Reps | | | | 20 |
| Classroom | F84 | 7503 | | | | | |
| Storeroom | F86 | 7505 | | | | | |
| Privacy | F76 | 7520 | | | | | |
| Passage | F75 | 7530 | | | | | |
| Single Dummy | ---- | 7540 | | | | | 40 |



► **PACKAGING INCLUDES**

- Adjustable 2 3/8" to 2 3/4" backset square corner. Preset 2 3/8"
- Standard "C", 6-pin cylinder
- T-strike

► **KEYWAYS**

6-pin solid brass "C" keyway standard. Optional: Schlage E, Schlage C-K, Russwin D1-2-3-4, Corbin 59 / 60, Corbin-Russwin L4, Sargent LA-LB-LC, Falcon / Weiser E, Arrow A, Yale 8, Yale GA and Kwikset.
Can also accept Medeco, Assa, Kaba and **Cal-Royal HSK** High Security Cylinders.

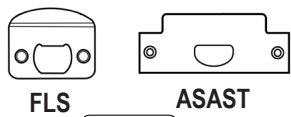
► **ADDITIONAL PARTS**

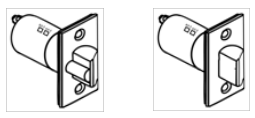
| ILLUSTRATION | ITEM # | DESCRIPTION | FINISH | |
|---|--|---|--------------------------------------|--|
|  <p>FLS ASAST</p>  <p>EXASA-175</p> | FLS | Full Lip Strike | US3, 26D, 10B, 10, 15, 26, 4, 5, 15A | For pricing & availability inquiries contact your Local Distributor or click here for the list of our Sales Reps |
| | ASAST | ASAANSI Strike | US3, 26D, 26 US10, 10B, 4, 5 | |
| | EXASA-175 | Extended Lip ANSI Strike 1 3/4" Lip Extension from Screw Center Line | US32D, DURO | |
|  <p>7500ADJ 7520ADJ</p> | 7500ADJ | 7500 Series Entrance Dead latch Adjustable 2 3/8" or 2 3/4" Backset 2 1/4" x 1" Faceplate | US3, 26D, 10B | |
| 7520ADJ | 7500 Series Privacy Spring latch Adjustable 2 3/8" or 2 3/4" Backset 2 1/4" x 1" Faceplate | | | |

HIL Series

INTERCONNECTED ENTRANCE LEVER SERIES

ANSI - A156.12 SERIES 5000, GRADE 2, UL LISTED

• Optional Interchangeable Core for Best, Falcon and Arrow
With Interconnecting Mechanism, **Can be used with 4" CTC**

| | | | |
|---|------------------------------|---|---|
| <small>3 HOUR FIRE RATED UL10C, UBC7-2-1997</small> | LIFETIME WARRANTY | BHMA™ CERTIFIED <small>Be Safe. Be Secure. Look for the Mark.</small> | MEETS <i>The Buy American Act</i> |
|---|------------------------------|---|---|

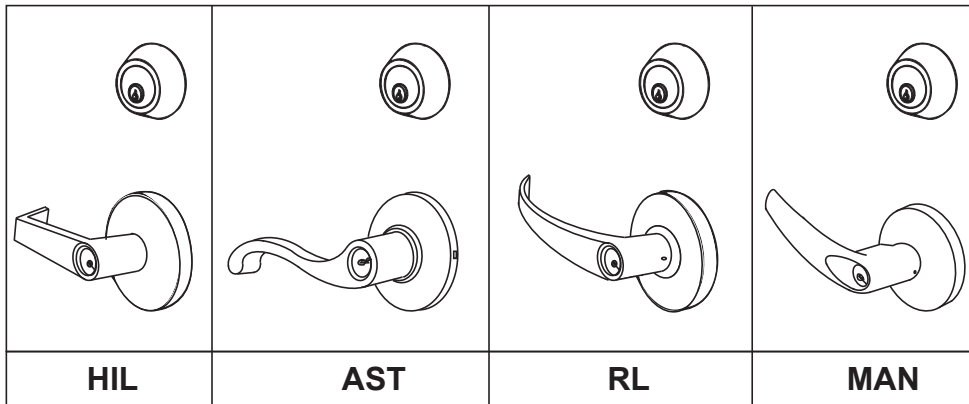

| FUNCTION | ANSI | ITEM # | US26D | US3, 15 | US10B | US4, 5, 26 | PCS / MC |
|---------------------------------|------|----------------------|--|---------|-------|------------|----------|
| Entrance, Double Locking | F109 | HIL00 | For pricing & availability inquiries contact your Local Distributor or click here for the list of our Sales Reps | | | | 10 |
| | | •• ICHIL00 | | | | | |
| Entrance, Single Locking | F75 | HIL30 | | | | | |
| | | • ICHIL30 | | | | | |
| Entrance, Double Locking | F109 | HILAST00 | | | | | |
| | | •• ICHILAST00 | | | | | |
| Entrance, Single Locking | F75 | HILAST30 | | | | | |
| | | • ICHILAST30 | | | | | |
| Entrance, Double Locking | F109 | HILRL00 | | | | | |
| | | •• ICHILRL00 | | | | | |
| Entrance, Single Locking | F75 | HILRL30 | | | | | |
| | | • ICHILRL30 | | | | | |
| Entrance, Double Locking | F109 | HILMAN00 | | | | | |
| | | •• ICHILMAN00 | | | | | |
| Entrance, Single Locking | F75 | HILMAN30 | | | | | |
| | | • ICHILMAN30 | | | | | |

* Specify handing when ordering AST design

• Indicates deadbolt available with Interchangeable Core. Cores are compatible 6 or 7 pin with **Best, Falcon and Arrow**.

•• Indicates deadbolt and entrance lever available with Interchangeable Core. Cores are compatible 6 or 7 pin with **Best, Falcon and Arrow**.

JHIL Series

INTERCONNECTED ENTRANCE LEVER SERIES

ANSI - A156.12 SERIES 5000, GRADE 2, UL LISTED

- Optional Interchangeable Core for Best, Falcon and Arrow
- Optional Large Format Interchangeable Core for Schlage
- With Interconnecting Mechanism, Can be used with 4" or 5 1/2" CTC

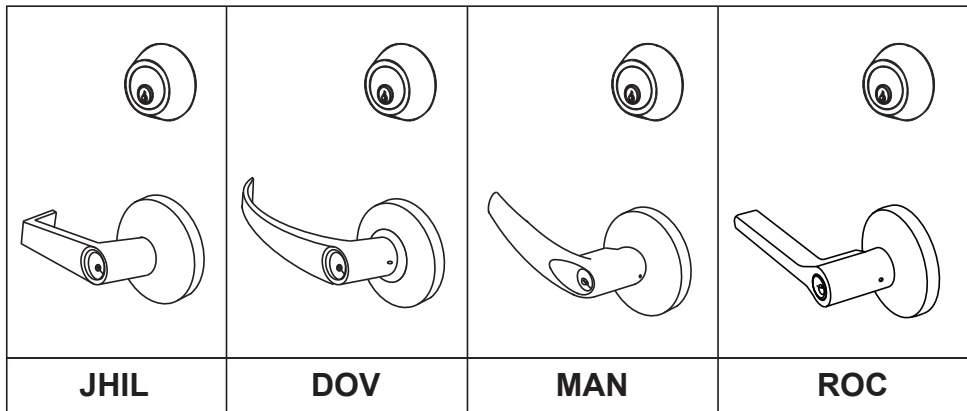

MEETS
The Buy American Act

| FUNCTION | ANSI | ITEM # | US26D | US3 | US15 | US10B | PCS / MC |
|---------------------------------|------|-----------------|--|-----|------|-------|----------|
| Entrance, Double Locking | F109 | JHIL00 | For pricing & availability inquiries contact your Local Distributor or click here for the list of our Sales Reps | | | | 10 |
| | | •• ICJHIL00 | | | | | |
| Entrance, Single Locking | F75 | JHIL30 | | | | | |
| | | • ICJHIL30 | | | | | |
| | | • ICSCJHIL30 | | | | | |
| Entrance, Double Locking | F109 | JHILROC00 | | | | | |
| | | •• ICJHILROC00 | | | | | |
| | | JHILROC30 | | | | | |
| Entrance, Single Locking | F75 | • ICJHILROC30 | | | | | |
| | | • ICSCJHILROC30 | | | | | |
| | | JHILDOV00 | | | | | |
| Entrance, Double Locking | F109 | •• ICJHILDOV00 | | | | | |
| | | JHILDOV30 | | | | | |
| | | • ICJHILDOV30 | | | | | |
| Entrance, Single Locking | F75 | • ICSCJHILDOV30 | | | | | |
| | | JHILMAN00 | | | | | |
| | | •• ICJHILMAN00 | | | | | |
| Entrance, Double Locking | F109 | JHILMAN30 | | | | | |
| | | • ICJHILMAN30 | | | | | |
| | | • ICSCJHILMAN30 | | | | | |

•• (IC) Indicates deadbolt available with Interchangeable Core. Cores are compatible 6 or 7 pin with **Best, Falcon and Arrow**.

• (ICSC) Indicates deadbolt available with Large Format Interchangeable Core for Schlage.

► **PACKAGING INCLUDES**





- UL Listed 2 3/4" backset, 2 1/4" x 1 1/8" faceplate for HIL Series
- UL Listed 2 3/4" backset, 2 1/4" x 1" faceplate with 1/8" plastic filler for **JHIL Series**
- Standard "C", 6-pin cylinder
- T-Strike, square strike 2 3/4" X 1 1/8" for deadbolt

► **KEYWAYS**

6-pin solid brass "C" keyway standard. Optional: Schlage E, Schlage C-K, Russwin D1-2-3-4, Corbin 59 / 60, Corbin-Russwin L4, Corbin-Russwin L4, Sargent LA-LB-LC, Falcon / Weiser E, Arrow A, Yale 8, Yale GA and Kwikset. Can also accept Medeco, Assa, Kaba and **Cal-Royal HSK** High Security Cylinders.

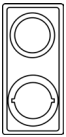
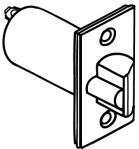
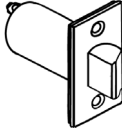
► **ADDITIONAL PARTS FOR HIL AND JHIL SERIES**

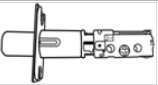
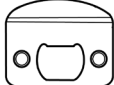
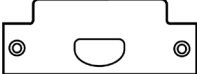
Backset: UL Listed 2 3/8" with 2 1/4" x 1 1/8" Faceplate

| ILLUSTRATION | ITEM # | DESCRIPTION | FINISH | | |
|---|------------|---|-------------------|--|--|
|  | HILESC1 | Escutcheon Plate for Exterior Trim for HIL and JHIL Series (JHIL used with 4" CTC Only) | US3, 26D, 15, 10B | For pricing & availability inquiries contact your Local Distributor or click here for the list of our Sales Reps | |
|  | UL-HIL238 | For HIL & JHIL: Dead Latch 2 3/8" for lever lock, 2 1/4" x 1" faceplate (for entry only) | US3, 26D, 10B | | |
| | UL-HIL234 | For HIL: Dead Latch 2 3/4" for lever lock 2 1/4" x 1 1/8" faceplate (for entry only) | | | |
| | ULJHIL234 | For JHIL: Dead Latch 2 3/4" for lever lock 2 1/4" x 1" faceplate (for entry only) | | | |
|  | UL-SHIL238 | FOR HIL & JHIL: 2 3/8" UL-listed Spring Latch, 2 1/4" x 1" faceplate (for passage only) | | | |
| | UL-SHIL234 | For HIL: 2 3/4" UL-listed Spring Latch 2 1/4" x 1 1/8" faceplate (for passage only) | | | |
| | ULSJHIL234 | For JHIL: 2 3/4" UL-listed Spring Latch 2 1/4" x 1" faceplate (for passage only) | | | |
|  | ULJHILADJ | Adjustable Deadbolt Latch 2 3/8" or 2 3/4" for JHIL | | | |
|  | T220ADJ | Adjustable Deadbolt Latch 2 3/8" or 2 3/4" for HIL | | | |
| STRIKES | | | | | |
|  | FLS | Full Lip Strike | | US3, 26D, 10B, 15, 4, 5, 26 | For pricing & availability inquiries contact your Local Distributor or click here for the list of our Sales Reps |
|  | ASAST | ASA Strike | US3, 26D US10B | | |
|  | EXASA-175 | Extended Lip ANSI Strike 1 1/4" Lip Extension from Screw Center Line | US32D, DURO | | |

EPIC Series

LIGHT DUTY CYLINDRICAL LEVERSETS

MEETS ANSI STANDARD A156.2, GRADE 3

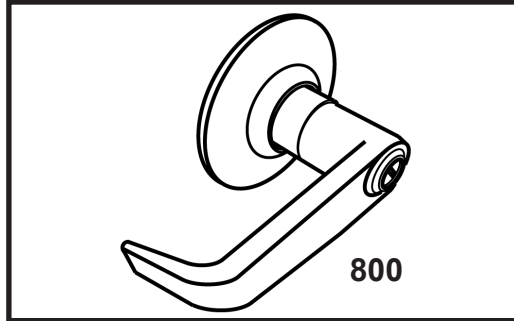

| COMMERCIAL PACKAGING | | | | | |
|--|------|---|-------------------------|--|----------|
| ENTRANCE leversets, Schlage "C" 5 pin keyway, KD packed with ASA Strike, 2 3/4" backset (1 1/8" x 2 1/4" square corner). | | | | | |
| ITEM # | ANSI | FUNCTION | FINISH | | PCS / MC |
| 800 | F109 | Entrance Cylindrical Lock with 4 7/8" ASA Commercial Strike, 5 pin Schlage "C" cylinder, KD | US26D, 3 | | 24 |
| 800 | | | US4 | | |
| 800 | | | US10B | | |
| ENTRANCE leversets, Schlage "C" 5 pin keyway, KD packed with ASA Strike, 2 3/4" backset (1 1/8" x 2 1/4" square corner). | | | | | |
| *802 | F76 | Privacy | US26D | | 24 |
| 803 | F75 | Passage | US26D | | |
| *802 | F76 | Privacy | US10B | | |
| 803 | F75 | Passage | US10B | | |
| *802 | F76 | Privacy | US4 | | |
| *802 | F76 | Bathroom (split finish) | US4 / US26D | | |
| 803 | F75 | Passage | US4 | | 36 |
| 805 | ---- | Dummy | US26D, 3, 5, 26, 10B, 4 | | |
| RESIDENTIAL PACKAGING | | | | | |
| PRIVACY AND PASSAGE leversets packed with Full Lip Strike round corner, 2 3/8" backset (1" x 2 1/4" round corner). | | | | | |
| ITEM # | ANSI | FUNCTION | FINISH | | PCS / MC |
| *RES802 | F76 | Privacy | US26D | | 24 |
| RES803 | F75 | Passage | US26D | | |
| *802 | F76 | Privacy | US3, 26 | | |
| 803 | F75 | Passage | US3, 26 | | |
| *802 | F76 | Privacy | US5 | | |
| 803 | F75 | Passage | US5 | | 36 |
| 805 | ---- | Dummy | US26D, 3, 5, 26, 10B, 4 | | |

*Turning inside lever or closing door releases button

**Other strikes and backsets available upon request subject to minimum quantity and lead time.

► **KEYWAYS**

5-pin solid brass "C" keyway standard.

► **ADDITIONAL PARTS FOR EPIC SERIES**

Backset: 2 3/8" with 2 1/4" x 1 1/8" Faceplate

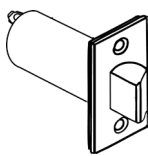
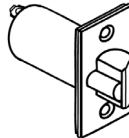
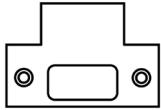
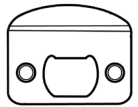
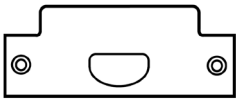
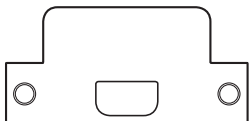
| ILLUSTRATION | ITEM # | DESCRIPTION | FINISH | |
|---|----------------------|---|----------------------|--|
|  | 8PAS238 | Round Corner 2 3/8" Passage Spring Latch | US3, 26D, 10B | For pricing & availability inquiries contact your Local Distributor or click here for the list of our Sales Reps |
| | 8PRI238 | Round Corner 2 3/8" Privacy Spring Latch | US3, 26D, 10B | |
| | ULSLS234 | Round Corner 2 3/4" Spring Latch | US3, 26D, 10B | |
|  | ULSLD234 | Square Corner 2 3/4" x 1 1/8" Dead latch | US3, 26D, 10B | |
| | EPD238 / ULSLD238 | Square Corner 2 3/8" x 1" Dead latch | US3, 26D, 10B | |
| STRIKES | | | | |
|  | TS | T-Strike | US3, 26D, 10B, 26, 4 | For pricing & availability inquiries contact your Local Distributor or click here for the list of our Sales Reps |
|  | FLS | Full Lip Strike | | |
|  | ASAST | ASA Strike | US3, 26D, 26 | |
| | | | US10B, 4 | |
|  | EXASA-175 | Extended Lip ANSI Strike 1 3/4" Lip Extension from Screw Center Line | US32D, DURO | |

KEYING

| ITEM # | DESCRIPTION | |
|--------|---|--|
| KARES | Key alike | For pricing & availability inquiries contact your Local Distributor or click here for the list of our Sales Reps |
| MKRES | Master key (Including KA) | |
| CMKRES | Builder construction master key (Including KA & MK) | |
| GMKRES | Grand master key (Including KA, MK) | |

CRB Series

HEAVY DUTY DEADBOLTS, ANSI STANDARD- A156.5, GRADE 1

- Optional Interchangeable Core for **Best, Falcon and Arrow**
- Optional Interchangeable Core for **Schlage Full Size** format

| | | | |
|--|--------------------------|--|---|
|  <small>3 HOUR FIRE RATED UL10C, UBC7-2-1997</small> | LIFETIME WARRANTY | BHMA TM CERTIFIED <small>Be Safe. Be Secure. Look for the Mark.</small> | MEETS <i>The Buy American Act</i> |
|--|--------------------------|--|---|

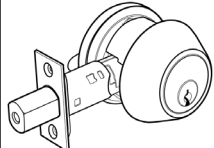
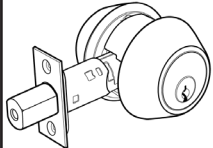
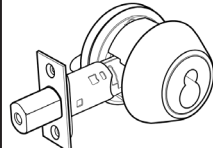
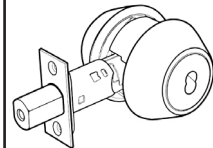
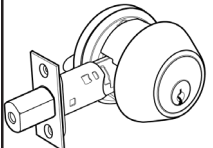
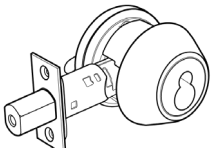
| | | | | | |
|---|---|--|--|---|---|
|  |  |  |  |  |  |
| CRB800 | CRB700 | <ul style="list-style-type: none"> ● ICCRB800 ● ICSCCRB800 | <ul style="list-style-type: none"> ● ICCRB700 | CRB600 | <ul style="list-style-type: none"> ● ICCRB600 ● ICSCCRB600 |

| FUNCTION | ANSI | ITEM # | US26D | US3, 15 | US10B | US4, 5, 26 | PCS / MC |
|--|--------------------------|--|--|---------|-------|------------|----------|
| Grade 1, UL Listed Single Cylinder Deadbolt, "C" Keyway | E0152 NEW ITEM | CRB800 | For pricing & availability inquiries contact your Local Distributor or click here for the list of our Sales Reps | | | | 20 |
| | | <ul style="list-style-type: none"> ● ICCRB800 ● ICSCCRB800 | | | | | |
| Grade 1, UL Listed Double Cylinder Deadbolt, "C" Keyway | E0142 | CRB700 | | | | | |
| | | <ul style="list-style-type: none"> ● ICCRB700 | | | | | |
| Classroom Deadbolt lock, Deadbolt thrown or retracted by key outside. Inside turn unit will retract bolt only. Bolt automatically deadlocks when fully thrown | F109 NEW ITEM | CRB600 | | | | | |
| | | <ul style="list-style-type: none"> ● ICCRB600 ● ICSCCRB600 | | | | | |

● (IC) Indicates deadbolt available with Interchangeable Core. Cores are compatible 6 or 7 pin with **Best, Falcon and Arrow**.

● (ICSC) Indicates deadbolt available with Large Format Interchangeable Core for Schlage.

► **PACKAGING INCLUDES**

- Standard "C" 6-pin cylinder
- Standard UL Listed 2 3/4" backset, optional 2 3/8" backset available. Please specify.
- Latch: Backset latch size 1 1/8" x 2 1/4" faceplate.
- Strike: 1 1/8" x 2 3/4", packed with 3" screws with wood frame reinforcer.

► **KEYWAYS**

6-pin solid brass "C" keyway standard. Optional: Schlage E, Schlage C-K, Russwin D1-2-3-4, Corbin 59 / 60, Corbin-Russwin L4, Corbin-Russwin L4, Sargent LA-LB-LC, Falcon / Weiser E, Arrow A, Yale 8, Yale GA and Kwikset. Can also accept Medeco, Assa, Kaba and **Cal-Royal HSK** High Security Cylinders.

► **ANTI MICROBIAL COATING**

Available on US26D and US32D finishes. Prefix "ANTB" before Part #.

► **ADDITIONAL PARTS FOR CRB SERIES**

Backsets: 2 3/8"

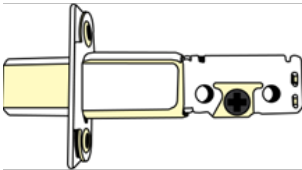
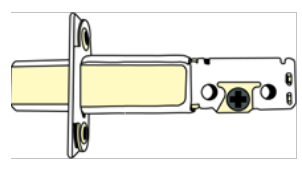
| ILLUSTRATION | ITEM # | DESCRIPTION | FINISH | |
|---|----------|---|---------------|--|
|  | B800-238 | 2 3/8" backset (2 1/4" x 1") faceplate | US3, 26D, 10B | For pricing & availability inquiries contact your Local Distributor or click here for the list of our Sales Reps |
|  | B800-234 | 2 3/4" backset (2 1/4" x 1 1/8") faceplate | US3, 26D, 10B | |

T300 Series

COMMERCIAL / RESIDENTIAL HEAVY DUTY DEADBOLTS

ANSI STANDARD A 156.5, GRADE 2

⚙️ **Optional Interchangeable Core for Best, Falcon and Arrow**
Optional Conversion Kit for up to 2 1/4" Thick Doors

| | | | |
|---|--------------------------|---|---|
| 3 HOUR FIRE RATED UL10C, UBC7-2-1997 | LIFETIME WARRANTY | MEETS <i>The Buy American Act</i> | HURRICANE APPROVED HARDWARE FLORIDA BUILDING CODE: FL13922-R1 ASTM E1886/E1996 ASTM E330 TAS 201, 202, 203 UL10B UL10C |
|---|--------------------------|---|---|

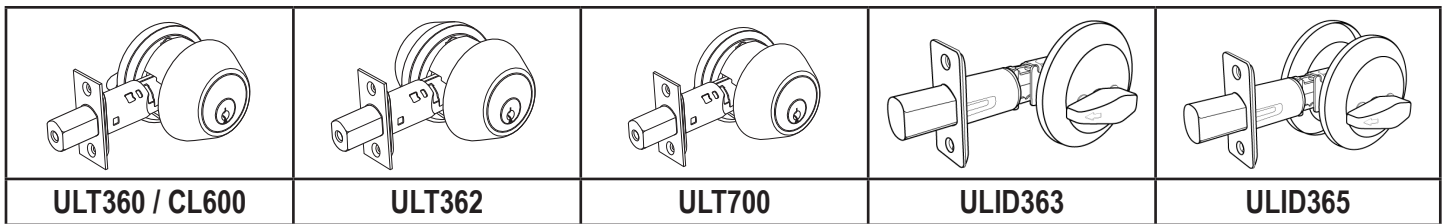

| FUNCTION | ANSI | ITEM # | US3 | US26D | US10B | US4 | US15 | US26 | US10 | US5 | PCS / MC |
|--|-------|-------------|-----|-------|-------|-----|------|------|------|-----|--|
| Heavy Duty Single Cylinder Deadbolt, UL Listed | E0152 | ULT360 | | | | | | | | | For pricing & availability inquiries contact your Local Distributor or click here for the list of our Sales Reps |
| Heavy Duty Single Cylinder Deadbolt, UL Listed | E0152 | ⚙️ ICULT360 | | | | | | | | | |
| Heavy Duty Double Cylinder Deadbolt, UL Listed | E0142 | ULT362 | | | | | | | | | |
| Heavy Duty Double Cylinder Deadbolt, UL Listed | E0142 | ⚙️ ICULT362 | | | | | | | | | |
| Classroom deadbolt lock. UL Listed. Deadbolt thrown or retracted by key outside. Inside turn unit will retract bolt only. Bolt automatically deadlocks when fully thrown. Fixed 2 3/4" backset latchbolt 2 3/8" Backset available upon request Part # ULJHILADJ | E0172 | CL600 | | | | | | | | | |
| | | ⚙️ ICCL600 | | | | | | | | | |
| UL Listed One Sided Latch Bolt retracted by thumb turn, no outside trim . Visible from one side of door only. | ---- | ULID363 | | | | | | | | | |
| UL Listed One Sided Latch Bolt retracted by thumb turn unit. Blank plate on external trim to be used on bore holes 1 3/8" and 2 1/8" diameter. | ---- | ULID365 | | | | | | | | | |
| UL Listed One-Way Deadbolt Lock Deadbolt thrown or retracted by key outside. Blank plate on internal trim to be used on bore holes 1 3/8" and 2 1/8" diameter. Bolt automatically deadlocks when fully thrown. (Exposed Screws) | E1161 | ULT700 | | | | | | | | | |
| | | ⚙️ ICULT700 | | | | | | | | | |

⚙️ (IC) Indicates functions available with Interchangeable Core. Cores are compatible 6 or 7 pin with **Best, Falcon and Arrow**.

► **PACKAGING INCLUDES**



- Standard "C" 6-pin cylinder
- Standard : Adjustable UL Listed 3 Hour Fire Rating 2 3/8" or 2 3/4" latchbolt.
- Latch: Backset latch size 1" x 2 1/4" faceplate, packed with latch front adapter to convert 1" face plate for 1 1/8" wide door preparations
- Strike: 1 1/8" x 2 3/4", packed with 3" screws with wood frame reinforcer.

► **KEYWAYS**

6-pin solid brass "C" keyway standard. Optional: Schlage E, Schlage C-K, Russwin D1-2-3-4, Arrow A, Corbin 59 / 60, Corbin-Russwin L4, Sargent LA-LB-LC, Falcon / Weiser E, Yale 8, Yale GA and Kwikset. Can also accept Medeco, Assa, Kaba and **Cal-Royal HSK** High Security Cylinders.

► **ADDITIONAL PARTS FOR T300 SERIES**

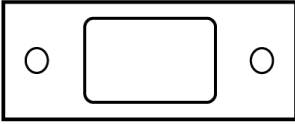
Backsets: 2 3/8"

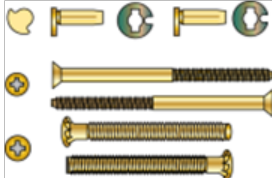
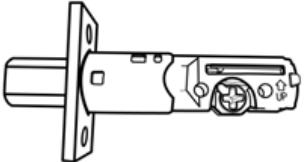
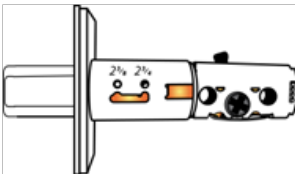
| ILLUSTRATION | ITEM # | DESCRIPTION | FINISH | |
|---|-----------|--|---------------|--|
|  | T2STRK | Deadbolt strike 1 1/8" X 2 3/4" | US3, 10B, 26D | For pricing & availability inquiries contact your Local Distributor or click here for the list of our Sales Reps |
|  | CONVT360 | Conversion Kit for 2 1/4" thick doors with tail piece and screws for ULT360 Single Cylinder Deadbolt | | |
|  | CONVT362 | Conversion Kit for 2 1/4" thick doors with tail piece and screws for ULT362 Double Cylinder Deadbolt | | |
|  | ULT360ADJ | 2 3/8"- 2 3/4" Adjustable Latch bolt for ULT360 and ULT362 | | |
|  | ULJHILADJ | Adjustable Deadbolt Latch 2 3/8" or 2 3/4" for CL600 Classroom Deadbolt | | |

T400 Series

COMMERCIAL / RESIDENTIAL HEAVY DUTY DEADBOLTS

ANSI STANDARD A 156.5, GRADE 2

OPTIONAL 6-PIN "C" OR 5-PIN KWIKSET KW1 KEYWAY

**LIFETIME
WARRANTY**

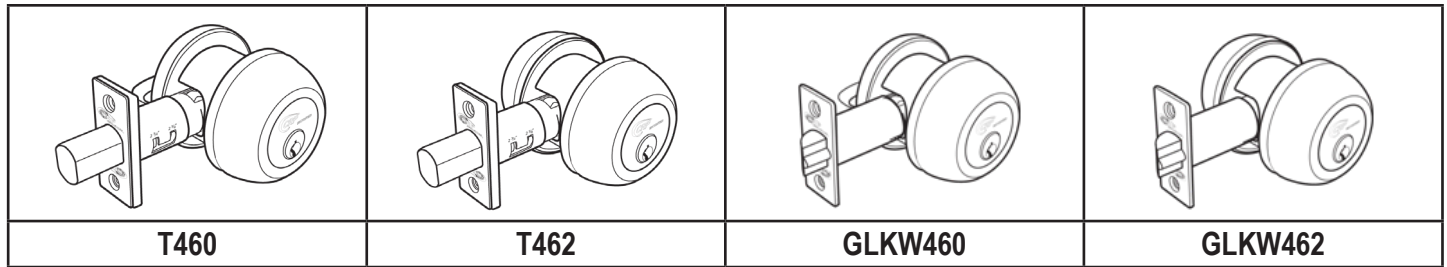

| DESCRIPTION | ANSI | ITEM # | US26D, US15, US3 | US10B, VB (Venetian Bronze) | US5 | PCS / MC |
|---|-------|---------------|--|--------------------------------|-----|-------------|
| Single Cylinder Deadbolt, 6-pin "C" Keyway | E0152 | T460 | For pricing & availability inquiries contact your Local Distributor or click here for the list of our Sales Reps | | | 20 |
| Double Cylinder Deadbolt, 6-pin "C" Keyway | E0142 | T462 | | | | |
| Single Cylinder Deadbolt, 5-pin Kwikset KW1 Keyway | E0152 | KWT460 | | | | |
| Double Cylinder Deadbolt, 5-pin Kwikset KW1 Keyway | E0142 | KWT462 | | | | |

| | | | | | | |
|---|-------|--|--|--|--|----|
| Single Cylinder Deadbolt, 6-pin "C" Keyway | E0152 | GL460 2 3/8" Backset | For pricing & availability inquiries contact your Local Distributor or click here for the list of our Sales Reps | | | 20 |
| Single Cylinder Gate Latch, 6-pin "C" Keyway | E0152 | GL460 / 234 2 3/4" Backset | | | | |
| Double Cylinder Gate Latch, 6-pin "C" Keyway | E0142 | GL462 2 3/8" Backset | | | | |
| Double Cylinder Gate Latch, 6-pin "C" Keyway | E0142 | GL462 / 234 2 3/4" Backset | | | | |
| Single Cylinder Gate Latch, 5-pin Kwikset KW1 Keyway | E0152 | GLKW460 2 3/8" Backset | | | | |
| Single Cylinder Gate Latch, 5-pin Kwikset KW1 Keyway | E0152 | GLKW460 / 234 2 3/4" Backset | | | | |
| Double Cylinder Gate Latch, 5-pin Kwikset KW1 Keyway | E0142 | GLKW462 2 3/8" Backset | | | | |
| Double Cylinder Gate Latch, 5-pin Kwikset KW1 Keyway | E0142 | GLKW462 / 234 2 3/4" Backset | | | | |

► **PACKAGING INCLUDES**

- Optional Standard "C" 6-pin cylinder or 5-pin Kwikset KW1
- Adjustable 2 3/4" and 2 3/8" backset.
- Latch: Standard 2 1/4" x 1" packed with 1 1/8" plastic filler to convert face plate to 1 1/8" wide door preparations
- Strike: 1 1/8" x 2 3/4", packed with 1 1/2" screws with wood frame reinforcer.

► **KEYWAYS**

Optional 6-pin solid brass "C" or 5 pin Kwikset KW1 keyway standard. Optional: Schlage E, Schlage C-K, Arrow A, Russwin D1-2-3-4, Corbin 59 / 60, Corbin-Russwin L4, Corbin-Russwin L4, Sargent LA-LB-LC, Falcon / Weiser E, Yale 8 and Yale GA. Can also accept Medeco, Assa, Kaba and **Cal-Royal HSK** High Security Cylinders.

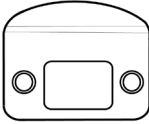
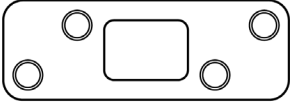
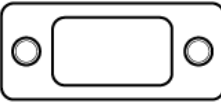
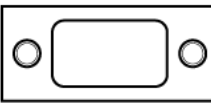
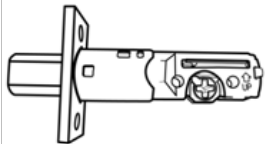
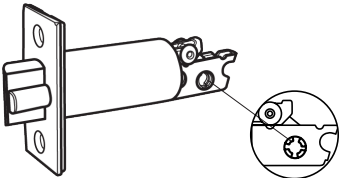
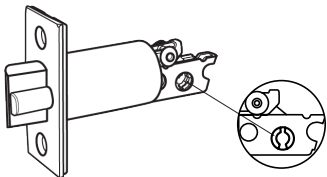

► **ADDITIONAL PARTS FOR T400 SERIES**

| ILLUSTRATION | ITEM # | DESCRIPTION | FINISH | |
|---|-----------|---|--------------------------|--|
|  | T2STRK | Deadbolt strike 1 1/8" X 2 3/4" | US3, 10B, 26D | For pricing & availability inquiries contact your Local Distributor or click here for the list of our Sales Reps |
|  | DBFLS | Deadbolt Full Lip Strike, Round Corner | US3, 5, 10B, 15, 15A, 26 | |
|  | SS114358 | Deadbolt Security Strike 1 1/4" x 3 5/8", 1/4" Rad. | US3, 5, 26D | |
|  | DBS1214RC | Deadbolt Strike Round Corner 1" X 2 1/4", 1/4" Rad. | | |
|  | DBS1214SC | Adjustable Deadbolt Latch 2 3/8" or 2 3/4" for CL600 Classroom Deadbolt | | |
|  | T460ADJ | Adjustable 2 3/4" and 2 3/8" Latch Bolt | US3, 10B, 26D | |
|  | GL238 | 2 3/8" backset gate latch and for double cylinder deadbolt | | |
| | GL234 | 2 3/4" backset gate latch and for double cylinder deadbolt | | |
|  | SINGL238 | 2 3/8" backset gate latch and for single cylinder deadbolt | | |
| | SINGL234 | 2 3/4" backset gate latch and for single cylinder deadbolt | | |

CB160 Series

**STANDARD DUTY DEADBOLTS, ANSI STANDARD - A156.5, GRADE 2
 COMMERCIAL / RESIDENTIAL GR 2 DEADBOLTS / DEAD LATCHES
 Grade 2 Specifications, Equivalent to Schlage B160 - Series Deadbolts**

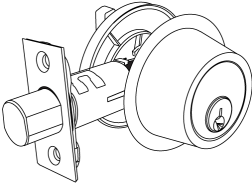
**LIFETIME
 WARRANTY**

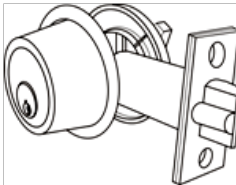
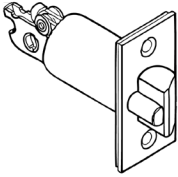
| | | | |
|---|---|--|---|
|  |  |  |  |
| CB160 | ADP160 | GL160 | GL238 (2 3/8") GL234 (2 3/4") |

| DESCRIPTION | ANSI | ITEM # | US3, 26D | US10, 10B, 26, 4, 5, 15 | PCS / MC |
|--|-------|---------------------------------|---|----------------------------|-------------|
| Standard Duty Single Cylinder Deadbolt | E0152 | CB160 | For pricing & availability inquiries contact your Local Distributor or click here for the list of our Sales Reps | | 36 |
| Standard Duty Double Cylinder Deadbolt | E0142 | CB162 | | | |
| Single Cylinder Gate Latch | E0152 | GL160 (2 3/8" backset) | | | |
| Double Cylinder Gate Latch | E0142 | GL162 (2 3/8" backset) | | | |
| Single Cylinder GateLatch | E0152 | GL160 / 234 (2 3/4" backset) | | | |
| Double Cylinder Gate Latch | E0142 | GL162234 (2 3/4" backset) | | | |

► **PACKAGING INCLUDES**



- 2 1/2" Diameter Adapter Ring for 2 1/8" Door Preparations
- Standard "C" 6-pin cylinder
- Adjustable 2 3/4" and 2 3/8" backset
- For gate latches Fixed 2 3/4" and 2 3/8" latch bolt
- Latch: Backset latch size 1" x 2 1/4" faceplate, packed with latch front adapter to convert 1" face plate for 1 1/8" wide door preparations
- Strike: 1 1/8" x 2 3/4"

► **KEYWAYS**

6-pin solid brass "C" keyway standard. Optional: Schlage E, Schlage C-K, Russwin D1-2-3-4, Corbin 59 / 60, Corbin-Russwin L4, Sargent LA-LB-LC, Falcon / Weiser E, Arrow A, Yale 8, Yale GA and Kwikset. Can also accept Medeco, Assa, Kaba and **Cal-Royal HSK** High Security Cylinders.

► **ADDITIONAL PARTS FOR CB160 SERIES**

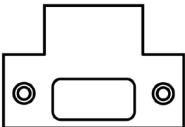
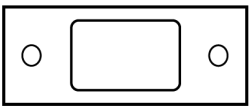
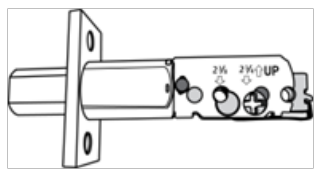
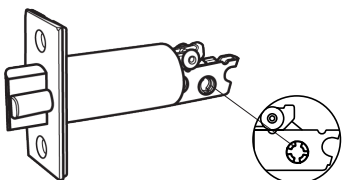
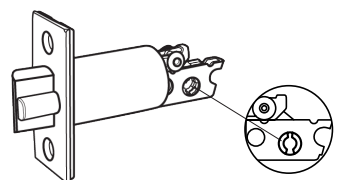
Backsets: 2 3/8"

| ILLUSTRATION | ITEM # | DESCRIPTION | FINISH | |
|---|----------|--|--|-----------------------------|
|  | TS | T-Strike | US3, 26D, 10B, 26, 10, 4, 15 | |
|  | T2STRK | Deadbolt Strike 1 1/8" X 2 3/4" | For pricing & availability inquiries contact your Local Distributor or click here for the list of our Sales Reps | |
|  | CB160ADJ | 2 3/8" - 2 3/4" Adjustable Latch bolt for CB160 | | |
|  | GL238 | 2 3/8" backset gate latch and for double cylinder deadbolt | | US3, 10B, 26D |
| | GL234 | 2 3/4" backset gate latch and for double cylinder deadbolt | | |
|  | SINGL238 | 2 3/8" backset gate latch and for single cylinder deadbolt | | US3, 10B, 26D |
| | SINGL234 | 2 3/4" backset gate latch and for single cylinder deadbolt | | |
|  | ADP160 | Adapter Ring | | US10B, 15, 26, 26D, 3, 4, 5 |

STANDARD DUTY DEADBOLTS *Series*

ANSI STANDARD- A156.5, GRADE 3

COMMERCIAL / RESIDENTIAL DEADBOLTS / DEAD LATCHES

- Optional Interchangeable Core for **Best, Falcon and Arrow**
- Optional Interchangeable Core for **Schlage Full Size** format

MEETS
The Buy American Act

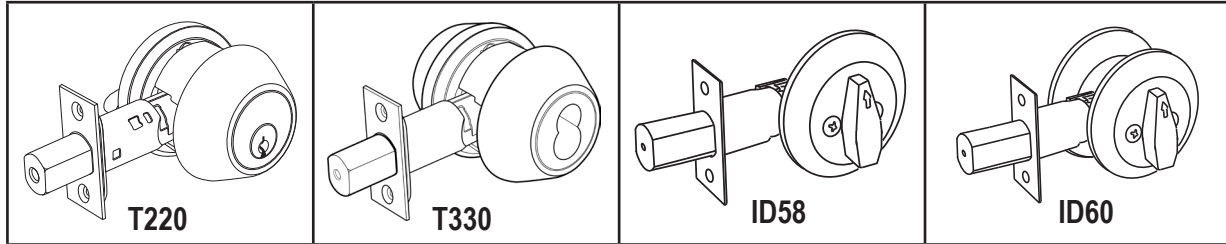

| DESCRIPTION | ANSI | ITEM # | US3, 26D | US10B | US10 | US15 | US26 | US32D | US5 | US4 | US1 | PCS / MC |
|--|-------|------------------|--|-------|------|------|------|-------|-----|-----|-----|----------|
| Standard Duty Single Cylinder Deadbolt | E0153 | T220 ● ICT220 | For pricing & availability inquiries contact your Local Distributor or click here for the list of our Sales Reps | | | | | | | | | 20 |
| Standard Duty Double Cylinder Deadbolt | E0143 | T330 ● ICT330 | | | | | | | | | | |

● (IC) Indicates functions available with Interchangeable Core. Cores are compatible 6 or 7 pin with **Best, Falcon and Arrow**.



| | | | | | | | | | | | | | |
|--|-------|------------|--|--|--|--|--|--|--|--|--|-----|----|
| Standard Duty Single Cylinder Deadbolt With Schlage Big Format IC | E0153 | ● SCICT220 | For pricing & availability inquiries contact your Local Distributor or click here for the list of our Sales Reps | | | | | | | | | --- | 20 |
| Standard Duty Double Cylinder Deadbolt With Schlage Big Format IC | E0143 | ● SCICT330 | | | | | | | | | | | |

● (SCIC) Indicates function available with **Schlage full size format Interchangeable Core**.

| | | | | | | | | | | | | | |
|---|-----|------|--|--|--|--|--|--|--|--|--|-----|----|
| Deadbolt thrown or retracted by turn unit only no outside trim. Bore halfway through door for installation visible from one side of door only | --- | ID58 | For pricing & availability inquiries contact your Local Distributor or click here for the list of our Sales Reps | | | | | | | | | --- | 50 |
| Deadbolt thrown or retracted by turn unit only. Blank plate is on external trim to be used on bore holes 1 5/8" and 2 1/8" wide | --- | ID60 | | | | | | | | | | | |

► **ADDITIONAL PARTS FOR STANDARD DUTY DEADBOLTS SERIES**

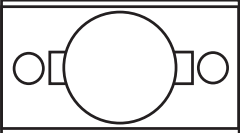
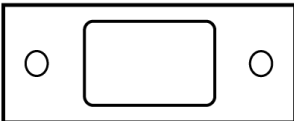
Backsets: 2 3/8"

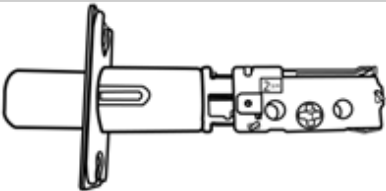
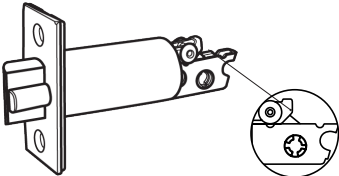
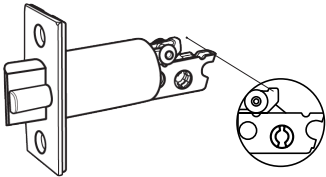
| ILLUSTRATION | ITEM # | DESCRIPTION | FINISH | |
|---|----------|--|------------------|--|
|  | LFA18 | Latch front adapter to convert 1" Plate to 1 1/8" wide door preparations | CLEAR | For pricing & availability inquiries contact your Local Distributor or click here for the list of our Sales Reps |
|  | T2STRK | Deadbolt strike 1 1/8" x 2 3/4" | US3, 10B, 26D | |
|  | T22DRI-6 | 2 3/8" Drive-in Latch bolt for T220 / T330 Deadbolt | ZINC | |
| | T22DRI-3 | 2 3/4" Drive-in Latch bolt for T220 / T330 Deadbolt | | |
|  | T220ADJ | 2 3/8" - 2 3/4" Adjustable Latch bolt for T220 / T330 Deadbolt | US3, 10B, 26D | |
|  | GL238 | 2 3/8" backset gate latch and for double cylinder deadbolt | | |
| | GL234 | 2 3/4" backset gate latch and for double cylinder deadbolt | | |
|  | SINGL238 | 2 3/8" backset gate latch and for single cylinder deadbolt | | |
| | SINGL234 | 2 3/4" backset gate latch and for single cylinder deadbolt | | |

► **PACKAGING INCLUDES**

- Standard "C" 6-pin cylinder.
- Adjustable 2 3/4" and 2 3/8" backset.
- Latch bolt size: 1" x 2 1/4".
- Latch front adapter is supplied in packaging to convert 1" faceplate for 1 1/8" wide door preparations.

► **KEYWAYS**

6-pin solid brass "C" keyway standard. Optional: Schlage E, Schlage C-K, Russwin D1-2-3-4, Corbin 59 / 60, Corbin-Russwin L4, Sargent LA-LB-LC, Falcon / Weiser E, Arrow A, Yale 8, Yale GA and Kwikset. Can also accept Medeco, Assa and Kaba High Security Cylinders.

GATE LATCH DEAD LATCHES Series

● Optional Interchangeable Core for **Best, Falcon and Arrow**

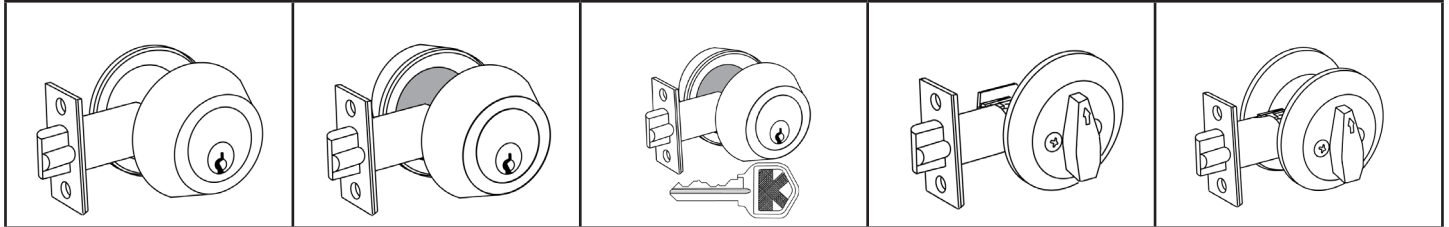

GL220

GL330

KWGLT

GL58

GL60

| DESCRIPTION | ANSI | ITEM # | US3 | US26D | US4 | US10B | US10 | US15 | US26 | US5 | PCS / MC |
|---|-------|--|--|-------|-----|-------|------|------|------|-----|----------|
| Single Cylinder Gate Latch, "C" Keyway | E0153 | GL220 ● ICGL220 (2 3/8" backset) | For pricing & availability inquiries contact your Local Distributor or click here for the list of our Sales Reps | | | | | | | | 20 |
| Single Cylinder Gate Latch, "C" Keyway | E0153 | GL220234 ● ICGL220234 (2 3/4" backset) | | | | | | | | | |
| Single Cylinder Gate Latch, Kwikset Keyway | E0153 | KWGLT220 (2 3/8" backset) | | | | | | | | | |
| Single Cylinder Gate Latch, Kwikset Keyway | E0153 | KWGLT220234 (2 3/4" backset) | | | | | | | | | |
| Double Cylinder Gate Latch, "C" Keyway | E0143 | GL330 ● ICGL330 (2 3/8" backset) | | | | | | | | | |
| Double Cylinder Gate Latch, "C" Keyway | E0143 | GL330234 ● ICGL330234 (2 3/4" backset) | | | | | | | | | |
| Double Cylinder Gate Latch, Kwikset Keyway | E0143 | KWGLT330 (2 3/8" backset) | | | | | | | | | |
| Double Cylinder Gate Latch, Kwikset Keyway | E0143 | KWGLT330234 (2 3/4" backset) | | | | | | | | | |

● (IC) Indicates functions available with Interchangeable Core. Cores are compatible 6 or 7 pin with **Best, Falcon and Arrow**.

| DESCRIPTION | ITEM # | US3 | US26D | US4 | US10B | US10 | US15 | US26 | US5 | PCS / MC |
|--|-----------------------------|--|-------|-----|-------|------|------|------|-----|----------|
| Gate latch retracted by turn unit only no outside trim. Bore halfway through door for installation visible from one side of door only. | GL58 (2 3/8" backset) | For pricing & availability inquiries contact your Local Distributor or click here for the list of our Sales Reps | | | | | | | | 50 |
| Gate latch retracted by turn unit only. Blank plate is on external trim to be used on bore holes 1 5/8" x and 2 1/8" wide. | GL60 (2 3/8" backset) | | | | | | | | | |
| Gate latch retracted by turn unit only no outside trim. Bore halfway through door for installation visible from one side of door only. | GL58234 (2 3/4" backset) | | | | | | | | | |
| Gate latch retracted by turn unit only. Blank plate is on external trim to be used on bore holes 1 5/8" x and 2 1/8" wide. | GL60234 (2 3/4" backset) | | | | | | | | | |



► **PACKAGING INCLUDES**

- Standard "C" 6-pin cylinder or Kwikset KW
- Standard 2 3/8" backset or 2 3/4". Specify backset.
- Latch bolt size: 1 1/8" x 2 1/4"
- Strike size: 1 1/8" x 2 3/4"

► **KEYWAYS**

6-pin solid brass "C" keyway standard.

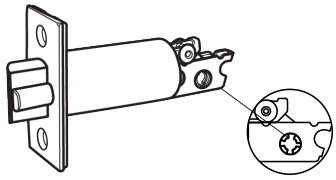
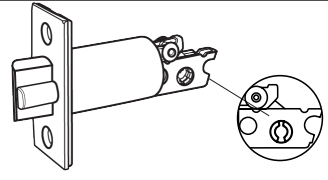
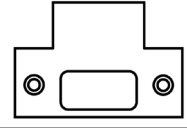
► **ADDITIONAL PARTS FOR GATE LATCH DEAD LATCHES SERIES**

| ILLUSTRATION | ITEM # | DESCRIPTION | FINISH |
|---|----------|--|---|
|  | GL238 | 2 3/8" backset gate latch and for double cylinder deadbolt | US3, 10B, 26D For pricing & availability inquiries contact your Local Distributor or click here for the list of our Sales Reps |
| | GL234 | 2 3/4" backset gate latch and for double cylinder deadbolt | |
|  | SINGL238 | 2 3/8" backset gate latch and for single cylinder deadbolt | |
| | SINGL234 | 2 3/4" backset gate latch and for single cylinder deadbolt | |
|  | TS | T-Strike | US3, 26D, 10B, 26, 4, 10, 15 |
|  | T2STRK | Deadbolt Strike 1 1/8" X 2 3/4" | US3, 10B, 26D |

LSD Series

LIGHT COMMERCIAL/RESIDENTIAL STANDARD DUTY DEADBOLTS, ANSI Grade 3

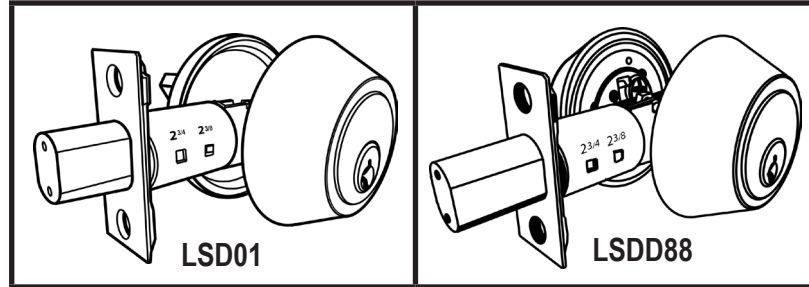

| DESCRIPTION | ANSI | ITEM # | US3, 26D, US32D | US10B, 5, 15 | US32 | PCS / MC |
|--|-------|--------|--|--------------|------|----------|
| Standard Duty Single Cylinder Deadbolt | E0153 | LSD01 | For pricing & availability inquiries contact your Local Distributor or click here for the list of our Sales Reps | | | 36 |
| Standard Duty Double Cylinder Deadbolt | E0143 | LSDD88 | | | | 36 |

► PACKAGING INCLUDES

- Standard "C" 6-pin cylinder
- Adjustable 2 3/4" and 2 3/8" backset
- Latch: Backset latch size 1" x 2 1/4" faceplate. Latch front adapter is available to convert 1" face plate for 1 1/8" wide door preparations. See below.
- Strike size: 1 1/8" x 2 3/4"

► KEYWAYS

6-pin solid brass "C" keyway standard. Optional: Schlage E, Schlage C-K, Russwin D1-2-3-4, Corbin 59 / 60, Corbin-Russwin L4, Sargent LA-LB-LC, Falcon / Weiser E, Arrow A, Yale 8, Yale GA and Kwikset. Can also accept Medeco, Assa, Kaba and **Cal-Royal HSK** High Security Cylinders.

► ADDITIONAL PARTS

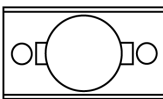
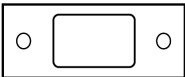
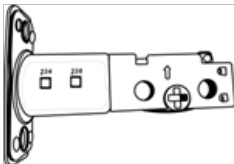
| ILLUSTRATION | ITEM # | DESCRIPTION | FINISH | |
|---|----------|---|---------------|--|
|  | LFA18 | Latch front adapter to convert 1" face plate to 1 1/8" wide door preparations | CLEAR | For pricing & availability inquiries contact your Local Distributor or click here for the list of our Sales Reps |
|  | T2STRK | Deadbolt strike 1 1/8" X 2 3/4" | US3, 10B, 26D | |
|  | ED500ADJ | ED500 Adjustable Latch bolt, round corner 1" X 2 1/4" | US3, 10B, 26D | |

IND84 Indicator Deadbolts Series

COMMERCIAL / RESIDENTIAL INDICATOR DEADBOLTS 3

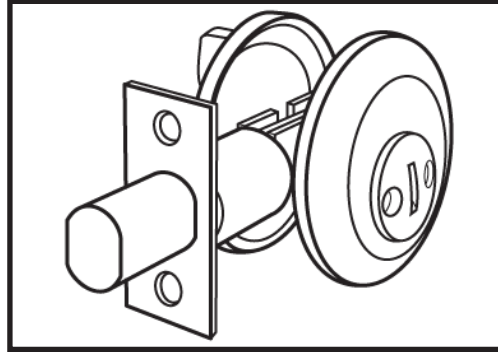



| ITEM # | DESCRIPTION | US3, 4, 26D | US10B | PCS/ MC |
|--------|--------------------|--|-------|------------|
| IND84 | Indicator Deadbolt | For pricing & availability inquiries contact your Local Distributor or click here for the list of our Sales Reps | | 36 |

► **PACKAGING INCLUDES**

- Adjustable 2 3/4" and 2 3/8" backset
- Latch: Backset latch size 1" x 2 1/4" faceplate. Latch front adapter is provided to convert 1" face plate for 1 1/8" wide door preparations. See below.
- Strike size: 1 1/8" x 2 3/4"

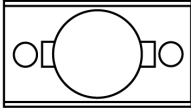
► **ADDITIONAL PARTS**

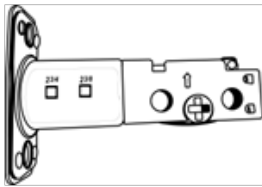
| ILLUSTRATION | ITEM # | DESCRIPTION | FINISH | |
|---|----------|---|---------------|--|
|  | LFA18 | Latch front adapter to convert 1" face plate to 1 1/8" wide door preparations | CLEAR | For pricing & availability inquiries contact your Local Distributor or click here for the list of our Sales Reps |
|  | T2STRK | Deadbolt strike 1 1/8" X 2 3/4" | US3, 10B, 26D | |
|  | ED500ADJ | ED500 Adjustable Latch bolt, round corner 1" X 2 1/4" | US3, 10B, 26D | |

ASHLEY Series

RESIDENTIAL TUBULAR LOCKSETS AND LEVERSETS

ANSI STANDARD A156.2, GRADE 3

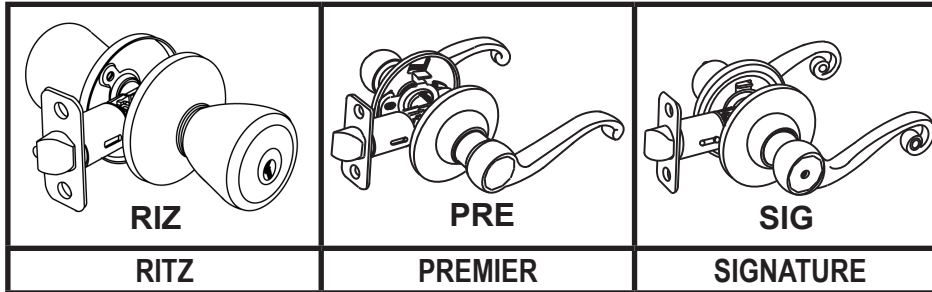

► KEYWAYS KW 5-PIN KWIKSET

► KNOB DESIGNS

RITZ ----- RIZ SERIES

| FUNCTIONS | ANSI | ITEM # | US3 | US26D | US5 | US15 | US4, 15A, 10B | US26 | PCS / MC |
|----------------|------|------------|--|-------|-----|------|------------------|------|-------------|
| Entry KA / 3 | F109 | RIZ00 | For pricing & availability inquiries contact your Local Distributor or click here for the list of our Sales Reps | | | | | | 36 |
| Storeroom KD | F86 | RIZ05 | | | | | | | |
| Privacy | F76 | RIZ20 | | | | | | | |
| Bathroom split | F76 | RIZ20 / 26 | | | | | | | |
| Passage | F75 | RIZ30 | | | | | | | |
| Dummy | ---- | RIZ40 | | | | | | | |

► LEVERSET DESIGNS

PREMIER ----- PRE SERIES

| FUNCTIONS | ANSI | ITEM # | US3, 26D | US15 | US10B | US26, 15A | US5 | US4 | PCS / MC |
|-------------------------------|------|------------|--|------|-------|--------------|-----|-----|-------------|
| Entry KD Lever / Lever *SH | F109 | LEPRE00 | For pricing & availability inquiries contact your Local Distributor or click here for the list of our Sales Reps | | | | | | 24 |
| Privacy *SH | F76 | PRE20 | | | | | | | |
| Bathroom split *SH | F76 | PRE20 / 26 | | | | | | | |
| Passage *SH | F75 | PRE30 | | | | | | | |
| Dummy *SH | ---- | PRE40 | | | | | | | 36 |

*SH is for specify handing

SIGNATURE ----- SIG SERIES

| FUNCTIONS | ANSI | ITEM # | US3 | US26D | US5 | US4,15A, 15,10B | US26 | PCS / MC | |
|----------------------------|------|------------|--|-------|-----|--------------------|------|-------------|----|
| Entry KD Lever / Lever *SH | F109 | LESIG00 | For pricing & availability inquiries contact your Local Distributor or click here for the list of our Sales Reps | | | | | | 24 |
| Privacy *SH | F76 | SIG20 | | | | | | | |
| Bathroom split *SH | F76 | SIG20 / 26 | | | | | | | |
| Passage *SH | F75 | SIG30 | | | | | | | |
| Dummy *SH | ---- | SIG40 | | | | | | | 36 |

*SH is for specify handing

Premier and Signature Series are reversible non-handed except **LESIG00**. Specify handing for convenience. If handing is not available at time of shipment opposite hand will be supplied.

► **PACKAGING INCLUDES**

- Adjustable steel 2 3/8" and 2 3/4" backset (2 1/4" x 1", 1/4" radius). Drive in latch bolt also available on request. Square corner available on request on special factory order with lead time and subject to minimum quantity.
- All locksets are packed with full lip strike round corner 1/4" radius.
- Square corner available on request.
- Kwikset rekeyable 5-pin cylinder.

► **ADDITIONAL PARTS FOR ASHLEY SERIES**

| ITEM # | DESCRIPTION | |
|-----------------------|---|--|
| DRESADJ | Entrance four way adjustable drive-in latch bolt, square corner | For pricing & availability inquiries contact your Local Distributor or click here for the list of our Sales Reps |
| SRESADJ | Privacy, passage four way adjustable drive-in latch bolt, square corner | |
| ASHADJ | Entrance standard adjustable latch bolt, round corner 1" x 2 1/4" | |
| TS | T-Strike | |
| FLS | Full lip strike | |
| ASAST US3, 26D, 26 | ANSI ASA strike | |
| ASAST US10B, 10 | | |
| EXASA-175 US32D, DURO | Extended Lip ANSI Strike, 1 3/4" Lip Extension from Screw Center Line | |
| K1-KEY | Blank keys K1 | |
| KEYS | Extra cut keys | |
| CRT800 | Cylinder removal tool | |
| LFA18 | Latch front adapter to convert 1" faceplate to 1 1/8" wide door preparation | |
| PDBFLS | Plastic Dust box for Full Lip Strike | |
| PDB1214 | Plastic Dust box for Residential Deadbolt Strike 1" x 2 1/4" | |
| PDB118234 | Plastic Dust box for T-Strike 1 1/8" x 2 3/4" | |
| PDBTS | Plastic Dust box for Deadbolt T2STRK Strike | |
| PDB478 | Plastic Dust box for ASA Strike | |
| KEYING KITS | | |
| KKWI200 | Keying Kit - KWI Keyway | |
| MOUNT | | |
| RESMOUNT | 3 hole mount for residential locks | |

► **KEYING**

| ITEM # | DESCRIPTION | |
|--------|---|--|
| KARES | Key Alike | For pricing & availability inquiries contact your Local Distributor or click here for the list of our Sales Reps |
| MKRES | Master Key (Including KA) | |
| CMKRES | Builder Construction Master Key (Including KA & MK) | |
| GMKRES | Grand Master Key (Including KA, MK & CMK) | |

CHELSIE Series

RESIDENTIAL TUBULAR LOCKSETS, DEADBOLTS, LEVERS AND HANDLESETS, ANSI STANDARD A156.2, GRADE 3

► **KEYWAYS** (STD, "KW" 5-PIN KWIKSET) OPTIONAL 5-PIN SCHLAGE "C" & WEISER

- All locksets, handle sets and deadbolts are available with **Schlage "C"** and **Weiser** keyway on special factory order only. Consult factory.
- **SCHLAGE "C" KEYWAY OPTION:** Prefix C before Part # (Ex: REN00 with C keyway is CREN000)
- **WEISER KEYWAY OPTION:** Prefix "W" before Part # (Ex: REN00 with Weiser keyway is WREN00)

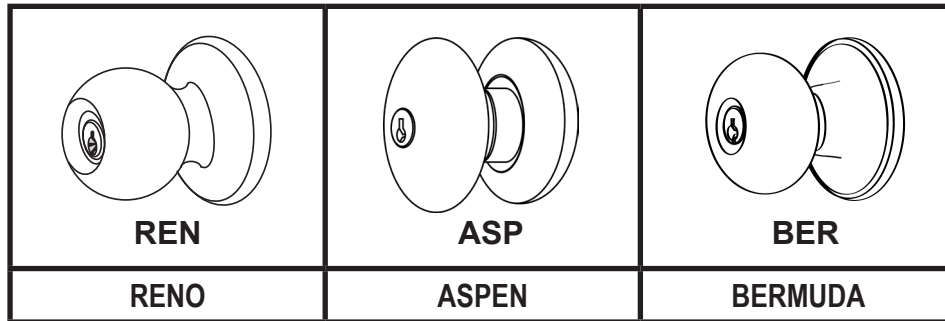

RENO ----- REN DESIGN

| FUNCTIONS | ANSI | ITEM # | US15 | US10B | US3, 26D, 32D | US5, US26 | US15A | PCS / MC |
|--------------------|------|------------------------|--|-------|---------------|-----------|-------|----------|
| Entry - KA / 3 | F109 | REN-00 | For pricing & availability inquiries contact your Local Distributor or click here for the list of our Sales Reps | | | | | 36 |
| Storeroom - KA / 3 | F86 | REN-05 ^{XXXX} | | | | | | |
| Privacy | F76 | REN-20 | | | | | | |
| Passage | F75 | REN-30 | | | | | | |
| Dummy | ---- | REN-40 | | | | | | |

 Prefix "UL" before Part # when ordering UL Listed, available on Entrance and Passage functions.
***REN05 US26 Non-Stock

ASPEN ----- ASP DESIGN

| FUNCTIONS | ANSI | ITEM # | US3 | US15 | US10B | US5, 15A, 26, 26D | PCS / MC |
|--------------------|------|--------|--|------|-------|-------------------|----------|
| Entry - KA / 3 | F109 | ASP-00 | For pricing & availability inquiries contact your Local Distributor or click here for the list of our Sales Reps | | | | 36 |
| Storeroom - KA / 3 | F86 | ASP-05 | | | | | |
| Privacy | F76 | ASP-20 | | | | | |
| Passage | F75 | ASP-30 | | | | | |
| Dummy | ---- | ASP-40 | | | | | |





 Prefix "UL" before Part # when ordering UL Listed, available on Entrance and Passage functions.

BERMUDA ----- BER DESIGN

| FUNCTIONS | ANSI | ITEM # | US3 | US15 | US10B | US5, 15A, 26, 26D | PCS / MC |
|--------------------|------|--------|--|------|-------|-------------------|----------|
| Entry - KA / 3 | F109 | BER-00 | For pricing & availability inquiries contact your Local Distributor or click here for the list of our Sales Reps | | | | 36 |
| Storeroom - KA / 3 | F86 | BER-05 | | | | | |
| Privacy | F76 | BER-20 | | | | | |
| Passage | F75 | BER-30 | | | | | |
| Dummy | ---- | BER-40 | | | | | |

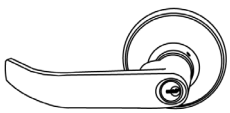
 Prefix "UL" before Part # when ordering UL Listed, available on Entrance and Passage functions.

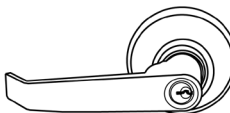
► CHELSIE SERIES LEVERSET DESIGNS

| | | | | |
|---|---|---|--|---|
|  MAY |  SOP |  LEN |  BRI |  AUS |
| MAYFAIR | SOPHIA | LENOX | BRISTOL | AUSTIN |

MAYFAIR ----- MAY DESIGN

| FUNCTIONS | ANSI | ITEM # | US3, 15 | US10B | US26D | US5 | US15A, 26 | PCS / MC |
|------------------------|------|--------|--|-------|-------|-----|-----------|----------|
| Entry - KA / 3 *SH | F109 | MAY-00 | For pricing & availability inquiries contact your Local Distributor or click here for the list of our Sales Reps | | | | | 24 |
| Storeroom - KA / 3 *SH | F86 | MAY-05 | | | | | | |
| Privacy *SH | F76 | MAY-20 | | | | | | |
| Passage *SH | F75 | MAY-30 | | | | | | |
| Active Dummy *SH | ---- | MAY-40 | | | | | | 36 |

 Prefix "UL" before Part # when ordering UL Listed, available on Entrance and Passage functions.
* SH is for Specify Handing

SOPHIA ----- SOP DESIGN

| FUNCTIONS | ANSI | ITEM # | US3, 15 | US10B | US26D | US5, 15A, 26 | PCS / MC |
|--------------------|------|--------|--|-------|-------|--------------|----------|
| Entry - KA / 3 | F109 | SOP-00 | For pricing & availability inquiries contact your Local Distributor or click here for the list of our Sales Reps | | | | 24 |
| Storeroom - KA / 3 | F86 | SOP-05 | | | | | |
| Privacy | F76 | SOP-20 | | | | | |
| Passage | F75 | SOP-30 | | | | | |
| Active Dummy | ---- | SOP-40 | | | | | 36 |

 Prefix "UL" before Part # when ordering UL Listed, available on Entrance and Passage functions.

LENOX ----- LEN DESIGN

| FUNCTIONS | ANSI | ITEM # | US3, 15 | US10B | US26D | US5, 26 | US15A | PCS / MC |
|--------------------|------|--------|--|-------|-------|---------|-------|----------|
| Entry - KA / 3 | F109 | LEN-00 | For pricing & availability inquiries contact your Local Distributor or click here for the list of our Sales Reps | | | | | 24 |
| Storeroom - KA / 3 | F86 | LEN-05 | | | | | | |
| Privacy | F76 | LEN-20 | | | | | | |
| Passage | F75 | LEN-30 | | | | | | |
| Active Dummy | ---- | LEN-40 | | | | | | 36 |

 Prefix "UL" before Part # when ordering UL Listed, available on Entrance and Passage functions.

BRISTOL ----- BRI DESIGN

| FUNCTIONS | ANSI | ITEM # | US15 | US10B | US3, 26D | US5, 15A, 26 | PCS / MC |
|--------------------|------|--------|--|-------|----------|--------------|----------|
| Entry - KA / 3 | F109 | BRI-00 | For pricing & availability inquiries contact your Local Distributor or click here for the list of our Sales Reps | | | | 24 |
| Storeroom - KA / 3 | F86 | BRI-05 | | | | | |
| Privacy | F76 | BRI-20 | | | | | |
| Passage | F75 | BRI-30 | | | | | |
| Active Dummy | ---- | BRI-40 | | | | | 36 |

 Prefix "UL" before Part # when ordering UL Listed, available on Entrance and Passage functions.

AUSTIN ----- AUS DESIGN

| FUNCTIONS | ANSI | ITEM # | US3, 15 | US10B | US5 | US26D | US15A, 26 | PCS / MC |
|--------------------|------|--------|--|-------|-----|-------|-----------|----------|
| Entry - KA / 3 | F109 | AUS-00 | For pricing & availability inquiries contact your Local Distributor or click here for the list of our Sales Reps | | | | | 24 |
| Storeroom - KA / 3 | F86 | AUS-05 | | | | | | |
| Privacy | F76 | AUS-20 | | | | | | |
| Passage | F75 | AUS-30 | | | | | | |
| Active Dummy | ---- | AUS-40 | | | | | | 36 |





 Prefix "UL" before Part # when ordering UL Listed, available on Entrance and Passage functions.

► LEVERSET PACKAGING INCLUDES

- Adjustable steel 2 3/8" and 2 3/4" backset (2 1/4" x 1", 1/4" radius). Drive in latch bolt also available on request. Square corner available on request on special factory order with lead time and subject to minimum quantity.
- All locksets are packed with full lip strike round corner 1/4" radius. Square corner available on request.
- Kwikset rekeyable 5 pin cylinder.

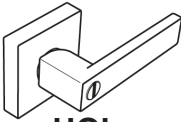
CONTEMPORARY Series

RESIDENTIAL LEVERS, ANSI STANDARD A156.2, GRADE 3

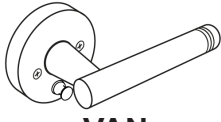
| | | | | |
|---|---|---|---|---|
|  HOL |  ATL |  JUP |  PHO |  VAN |
| HOLLAND | ATLAS | JUPITER | PHOENIX | VANITY |

HOLLAND ----- HOL DESIGN

| FUNCTIONS | | ANSI | ITEM # | US15 | US10B | US3, 26D | US5, 15A, 26 | PCS / MC |
|----------------|-----|------|--------|--|-------|----------|--------------|----------|
| Entry - KA / 3 | *NH | F109 | HOL-00 | For pricing & availability inquiries contact your Local Distributor or click here for the list of our Sales Reps | | | | 20 |
| Privacy | *NH | F76 | HOL-20 | | | | | |
| Passage | *NH | F75 | HOL-30 | | | | | |
| Dummy | *NH | ---- | HOL-40 | | | | | 36 |

* NH is for Non-Handed (Reversible) **NOT AVAILABLE WITH UL LATCH** ☒

ATLAS ----- ATL DESIGN

| FUNCTIONS | | ANSI | ITEM # | US15 | US10B | US3, 26D | US5, 15A, 26 | PCS / MC |
|-----------|-----|------|--------|--|-------|----------|--------------|----------|
| Privacy | *H | F76 | ATL20 | For pricing & availability inquiries contact your Local Distributor or click here for the list of our Sales Reps | | | | 20 |
| Passage | *NH | F75 | ATL30 | | | | | |
| Dummy | *NH | ---- | ATL40 | | | | | 36 |

* NH is for Non-Handed (Reversible) **NOT AVAILABLE WITH UL LATCH** ☒

* H is for Handed (Order Handing for Convenience)

JUPITER ----- JUP DESIGN

| FUNCTIONS | | ANSI | ITEM # | US15 | US10B | US3, 26D | US5, 15A, 26 | PCS / MC |
|----------------|----|------|--------|--|-------|----------|--------------|----------|
| Entry - KA / 3 | *H | F109 | JUP-00 | For pricing & availability inquiries contact your Local Distributor or click here for the list of our Sales Reps | | | | 20 |
| Privacy | *H | F76 | JUP-20 | | | | | |
| Passage | *H | F75 | JUP-30 | | | | | |
| Dummy | *H | ---- | JUP-40 | | | | | 36 |

* H is for Handed (Order Handing for Convenience) **NOT AVAILABLE WITH UL LATCH** ☒

PHOENIX ----- PHO DESIGN

| FUNCTIONS | | ANSI | ITEM # | US15 | US10B | US3, 26D | US5, 15A, 26 | PCS / MC |
|----------------|----|------|--------|--|-------|----------|--------------|----------|
| Entry - KA / 3 | *H | F109 | PHO-00 | For pricing & availability inquiries contact your Local Distributor or click here for the list of our Sales Reps | | | | 20 |
| Privacy | *H | F76 | PHO-20 | | | | | |
| Passage | *H | F75 | PHO-30 | | | | | |
| Dummy | *H | ---- | PHO-40 | | | | | 36 |

* H is for Handed (Order Handing for Convenience) **NOT AVAILABLE WITH UL LATCH** ☒

VANITY ----- VAN DESIGN

| FUNCTIONS | | ANSI | ITEM # | US15 | US10B | US3, 26D | US5, 15A, 26 | PCS / MC |
|-----------|-----|------|--------|--|-------|----------|--------------|----------|
| Privacy | *H | F76 | VAN-20 | For pricing & availability inquiries contact your Local Distributor or click here for the list of our Sales Reps | | | | 20 |
| Passage | *NH | F75 | VAN-30 | | | | | |
| Dummy | *NH | ---- | VAN-40 | | | | | 36 |

* NH is for Non-Handed (Reversible) **NOT AVAILABLE WITH UL LATCH** ☒

* H is for Handed (Order Handing for Convenience)

SUMMIT Series

WITH PUSH BUTTON LOCKING MECHANISM AND AUTO RELEASE FEATURE, ANSI STANDARD A156.2, GRADE 3

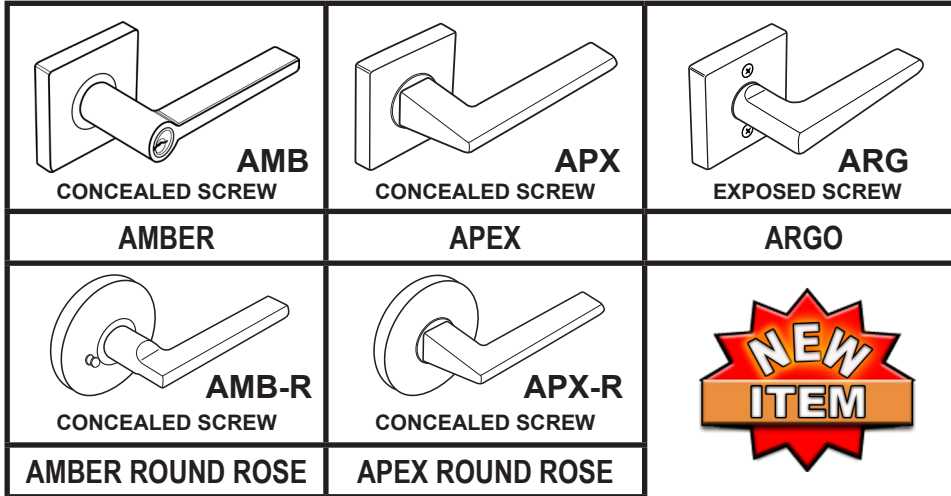

ALL DESIGNS HAVE PUSH BUTTON LOCKING MECHANISM & AUTO RELEASE FOR IMMEDIATE EGRESS, PANIC EXIT STRUCTURE ON PRIVACY FUNCTIONS. KEYED ENTRY FOR AMBER DESIGN ONLY.

AMBER ----- AMB SERIES

| FUNCTIONS | ANSI | ITEM # | US15 | US26 | US10B | US3, 26D | US5, 15A | PCS / MC |
|--------------|------|--------|--|------|-------|----------|----------|----------|
| Entrance *NH | --- | AMB-00 | For pricing & availability inquiries contact your Local Distributor or click here for the list of our Sales Reps | | | | | 20 |
| Privacy *NH | F76 | AMB-20 | | | | | | |
| Passage *NH | F75 | AMB-30 | | | | | | |
| Dummy *NH | --- | AMB-40 | | | | | | 36 |

Comes standard with Square Rose. Add Suffix "R" after Part # for Round Rose option.

For Example: To order **AMB-20 US15** with Round Rose, use "**AMB-20R US15**" when ordering.

* NH is for Non-Handed **NOT AVAILABLE WITH UL LATCH** ☒

APEX ----- APX SERIES

| FUNCTIONS | ANSI | ITEM # | US15 | US26 | US10B | US3, 26D | US5, 15A | PCS / MC |
|-------------|------|--------|--|------|-------|----------|----------|----------|
| Privacy *NH | F76 | APX-20 | For pricing & availability inquiries contact your Local Distributor or click here for the list of our Sales Reps | | | | | 20 |
| Passage *NH | F75 | APX-30 | | | | | | |
| Dummy *NH | --- | APX-40 | | | | | | 36 |

Comes standard with Square Rose. Add Suffix "R" after Part # for Round Rose option.

For Example: To order **APX-20 US15** with Round Rose, use "**APX-20R US15**" when ordering.

* NH is for Non-Handed **NOT AVAILABLE WITH UL LATCH** ☒





ARGO ----- ARG SERIES

| FUNCTIONS | ANSI | ITEM # | US15 | US26 | US10B | US3, 26D | US5, 15A | PCS / MC |
|-------------|------|--------|--|------|-------|----------|----------|----------|
| Privacy *NH | F76 | ARG-20 | For pricing & availability inquiries contact your Local Distributor or click here for the list of our Sales Reps | | | | | 20 |
| Passage *NH | F75 | ARG-30 | | | | | | |
| Dummy *NH | --- | ARG-40 | | | | | | 36 |

Comes standard with Square Rose.

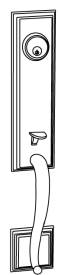
* NH is for Non-Handed **NOT AVAILABLE WITH UL LATCH** ☒

► **CHELSEIE SERIES HANDLESET DESIGNS**

| | | | | |
|---|---|---|---|---|
|  MER |  SAV |  CAM |  BAB |  DEE |
| MERIDIAN | SAVANNAH | CAMBRIDGE | BAYBRIDGE | DEERFIELD |

MERIDIAN ----- MER DESIGN

| FUNCTIONS | ITEM # | PVD US3 | US10B | US5,15, 15A, 26 | PCS / MC |
|--|--------|--|-------|-----------------|----------|
| Solid Brass Handle with single cylinder deadbolt KD | MER00 | For pricing & availability inquiries contact your Local Distributor or click here for the list of our Sales Reps | | | 10 |
| Dummy handle set with dummy deadbolt and matching trim | MER40 | | | | |

*** All above on the **MER Design** are for any design on knobs and lever sets for interior handle. **PRE Premier Design** is not available for interior handleset. All other trims designs are available. On **Chelsie Series** specify at time of order (Ex: MER00 / REN)

SAVANNAH ----- SAV DESIGN

| FUNCTIONS | ITEM # | PVD US3 | US10B | US5,15, 15A, 26 | PCS / MC |
|--|--------|--|-------|-----------------|----------|
| Solid Brass Handle with single cylinder deadbolt KD | SAV00 | For pricing & availability inquiries contact your Local Distributor or click here for the list of our Sales Reps | | | 10 |
| Dummy handle set with dummy deadbolt and matching trim | SAV40 | | | | |

*** All above on the **SAV Series** are for any design on knobs and lever sets for interior handle. **SIG Signature / PRE Premier Designs** are not available for interior handleset. All other trims designs are available. On **Chelsie Series** specify at time of order (Ex: SAV00 / REN)

CAMBRIDGE ----- CAM DESIGN

| FUNCTIONS | ITEM # | PVD US3 | US10B | US5,15, 15A, 26 | PCS / MC |
|--|--------|--|-------|-----------------|----------|
| Solid Brass Handle with single cylinder deadbolt KD | CAM00 | For pricing & availability inquiries contact your Local Distributor or click here for the list of our Sales Reps | | | 10 |
| Dummy handle set with dummy deadbolt and matching trim | CAM40 | | | | |

*** All above on the **CAM Design** are for any design on knobs and lever sets for interior handle. **PRE Premier Design** is not available for interior handleset. All other trims designs are available. On **Chelsie Series** specify at time of order (Ex: CAM00 / REN)

BAYBRIDGE ----- BAB DESIGN

| FUNCTIONS | ITEM # | US15, 15A, 26 | US10B | US3, 26D | US5 | PCS / MC |
|--|--------|--|-------|----------|-----|----------|
| Handle w/ single cylinder deadbolt | BAB-00 | For pricing & availability inquiries contact your Local Distributor or click here for the list of our Sales Reps | | | | 10 |
| Dummy handle set with dummy deadbolt and matching trim | BAB-40 | | | | | |

*** All above on the **BAB Design** are for design knob for interior handle. **PRE Premier and SIG Signature Designs** are not available for interior handleset. All other trims designs are available. Specify at time of order (Ex: BAB00 / LENTRIM is BAB00 with LEN lever design on interior.)

DEERFIELD ----- DEE DESIGN

| FUNCTIONS | ITEM # | US3 | US15 | US10B | US5, 15A, 26 | US26D | PCS / MC |
|--|--------|--|------|-------|--------------|-------|----------|
| Handle with single cylinder deadbolt | DEE-00 | For pricing & availability inquiries contact your Local Distributor or click here for the list of our Sales Reps | | | | | 10 |
| Dummy handle set with dummy deadbolt and matching trim | DEE-40 | | | | | | |

*** All above on the **DEE Design** are for design knob for interior handle. **PRE Premier and SIG Signature Designs** are not available for interior handleset. All other trims designs are available. Specify at time of order (Ex: DEE00 / LENTRIM is DEE00 with LEN lever design on interior.)

► **CONTEMPORARY SERIES (ESQ DESIGN), AND CHELSIE SERIES DEADBOLT DESIGNS**

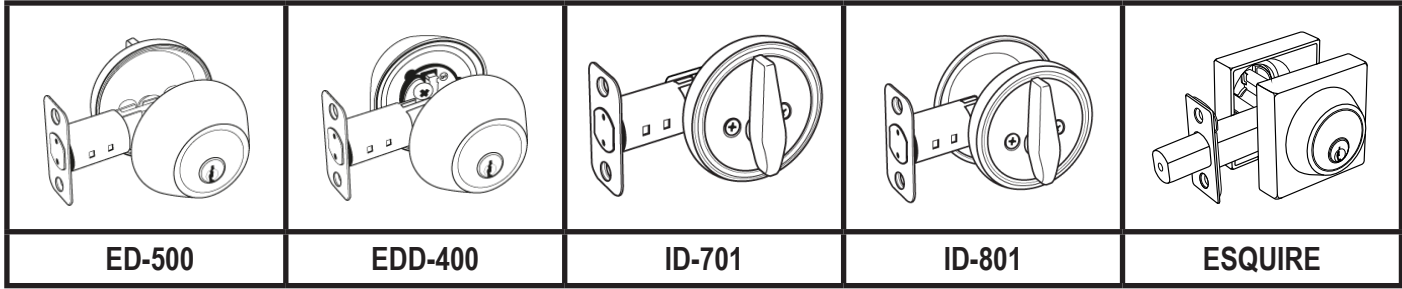

| FUNCTIONS | ITEM # | US3 | US15 | US26D | US10B | US15A | US32D | US5 | US26 | PCS / MC |
|--|----------|--|------|-------|-------|-------|-------|-----|------|----------|
| Single cylinder deadbolt | ED-500 | For pricing & availability inquiries contact your Local Distributor or click here for the list of our Sales Reps | | | | | | | | 36 |
| Single cylinder deadbolt  | ULED-500 | | | | | | | | | |
| Square single cylinder deadbolt | ESQ-101 | | | | | | | | | |
| Square double cylinder deadbolt | ESQ-102 | | | | | | | | | |
| Double cylinder deadbolt | EDD-400 | | | | | | | | | |
| One sided deadbolt | ID-701 | | | | | | | | | |
| One sided deadbolt with exterior cover plate | ID-801 | | | | | | | | | |

► **DEADBOLT AND HANDLESET PACKAGING INCLUDES:**

- Adjustable steel 2 3/8" and 2 3/4" backset (2 1/4" x 1", 1/4" radius). Drive in latch bolt also available on request. Square corner available upon request on special factory order with lead time.
- Deadbolts packed with 1" x 2 1/4" strike round corner 1/4" radius and full lip strike 1/4" radius. Square corner available upon request. On special factory order with lead time.

Security strike (1 ¼" x 3 ⅝", ¼" radius) with 3" screws available.

➤ Kwikset rekeyable 5 pin cylinder.

➤ **ADDITIONAL PARTS FOR CHELSIE, CONTEMPORARY, AND SUMMIT SERIES**

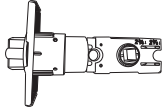
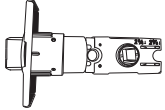
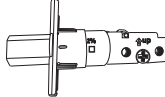
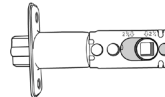
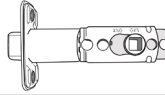
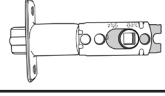
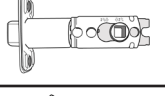
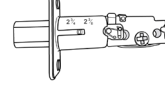
| ILLUSTRATION | ITEM # | DESCRIPTION |
|---|-----------|--|
|  | 4DRIVE2-1 | Entrance Four Way Adjustable Drive In Latch bolt, with removable Square Corner faceplate for knobssets |
| | 4DRIVE2-2 | Entrance Four Way Adjustable Drive In Latch bolt, with removable Square Corner faceplate for leversets |
|  | 4DRIVP2-1 | Privacy, Passage Four Way Adjustable Drive In Latch bolt, with removable Square Corner faceplate for knobssets |
| | 4DRIVP2-2 | Privacy, Passage Four Way Adjustable Drive In Latch bolt, with removable Square Corner faceplate for knobssets |
|  | 4DRIV31 | Deadbolt Four Way Adjustable Drive-In Latch bolt, with removable Square Corner faceplate |
|  | ENTK-4 | Adjustable Dead Latch 2 ⅜" or 2 ¾" with round corner faceplate for Entrance Knobssets |
|  | PASK-6 | Adjustable Spring Latch 2 ⅜" or 2 ¾" with round corner faceplate for Passage Knobssets |
|  | ENTL-5 | Adjustable Dead Latch 2 ⅜" or 2 ¾" with round corner faceplate for Entrance Leversets |
|  | PASL-7 | Adjustable Spring Latch 2 ⅜" or 2 ¾" with round corner faceplate for Passage Leversets |
|  | DB-8 | Adjustable Deadbolt Latch 2 ⅜" or 2 ¾" for Deadbolts |

For pricing & availability inquiries contact your Local Distributor or click [here](#) for the list of our Sales Reps

FOR USE with UL-Listed Chelsie Series Leversets and Deadbolts ONLY (MAY, SOP, LEN, BRI, AUS and ULED-500)

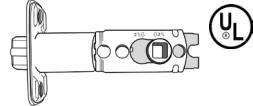
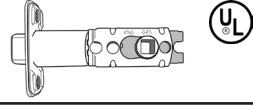
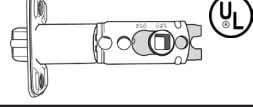
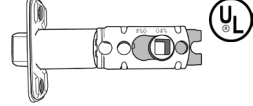
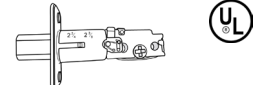
| | | |
|---|----------|--|
|  | ULENTK-4 | UL-Listed Adjustable Dead Latch 2 ⅜" or 2 ¾" with round corner faceplate for Entrance Knobssets |
|  | ULPASK-6 | UL-Listed Adjustable Spring Latch 2 ⅜" or 2 ¾" with round corner faceplate for Passage Knobssets |
|  | ULENTL-5 | UL-Listed Adjustable Dead Latch 2 ⅜" or 2 ¾" with round corner faceplate for Entrance Leversets |
|  | ULPASL-7 | UL-Listed Adjustable Spring Latch 2 ⅜" or 2 ¾" with round corner faceplate for Passage Leversets |
|  | ULDB-8 | UL-Listed Adjustable Deadbolt Latch 2 ⅜" or 2 ¾" for Deadbolts |

For pricing & availability inquiries contact your Local Distributor or click [here](#) for the list of our Sales Reps

► **ADDITIONAL PARTS FOR CHELSIE, CONTEMPORARY, AND SUMMIT SERIES**

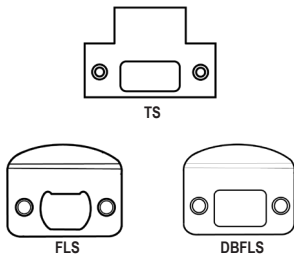
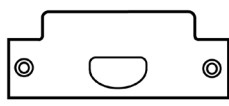
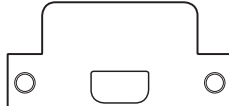
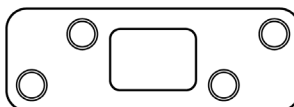
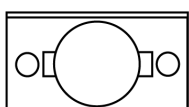
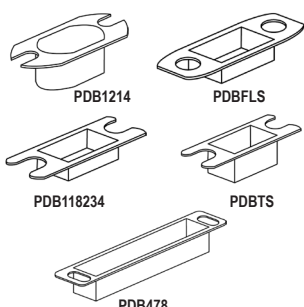
| ILLUSTRATION | ITEM # | DESCRIPTION |
|---|--------------------------|---|
|  | TS | T-Strike |
| | FLS | Full Lip Strike |
| | DBFLS | Deadbolt Full Lip Strike, Round Corner |
|  | ASAST US3, 26D, 26 | ANSI ASA Strike |
| | ASAST US10B, 10 | ANSI ASA Strike |
|  | EXASA-175 US32D, DURO | Extended Lip ANSI Strike 1 3/4" Lip Extension from Screw Center Line |
|  | SS114358 | Security Strike 1 1/4" X 3 5/8", 1/4" Rad With 2 pcs. each of 3" and 1 1/4" Screws US3, 5, 25, 26D, 10B |
| | K1-KEY | Blank Keys K1 |
| | KEYS | Extra Cut Keys |
|  | LFA18 | Latch Front Adapter To Convert 1" Faceplate To 1 1/8" Wide Door Preparation |
|  | PDBFLS | Plastic Dust box for Full Lip Strike |
| | PDB1214 | Plastic Dust box for Residential Deadbolt Strike 1" x 2 1/4" |
| | PDB118234 | Plastic Dust box for T-Strike 1 1/8" x 2 3/4" |
| | PDBTS | Plastic Dust box for Deadbolt T2STRK Strike |
| | PDB478 | Plastic Dust box for ASA Strike |
| ◆ KEYING KITS | | |
| | KKWI200 | Keying Kit - KWI Keyway |
| ◆ MOUNT | | |
| | RESMOUNT | 3 Hole Mount For Residential Locks |

For pricing & availability inquiries contact your Local Distributor or click [here](#) for the list of our Sales Reps

KEYING

| ITEM # | DESCRIPTION |
|--------|---|
| KARES | Key alike |
| MKRES | Master key (Including KA) |
| CMKRES | Builder construction master key (Including KA & MK) |
| GMKRES | Grand master key (Including KA, MK) |

For pricing & availability inquiries contact your Local Distributor or click [here](#) for the list of our Sales Reps

VANGUARD Series

RESIDENTIAL LEVERS AND DEADBOLTS, ANSI STANDARD A156.2, GRADE 3

► **KEYWAYS (STD, "KW" 5-PIN KWIKSET) OPTIONAL 5-PIN SCHLAGE "C" & WEISER**

- All locksets, and deadbolts are available with **Schlage "C"** and **Weiser** keyway on special factory order only. Consult factory.
- **SCHLAGE "C" KEYWAY OPTION:** Prefix C before Part # (Ex: MOD-00 with C keyway is CMOD-00)
- **WEISER KEYWAY OPTION:** Prefix "W" before Part # (Ex: MOD-00 with Weiser keyway is WMOD-00)

► **LEVERSET DESIGNS**

► **DEADBOLT DESIGNS**

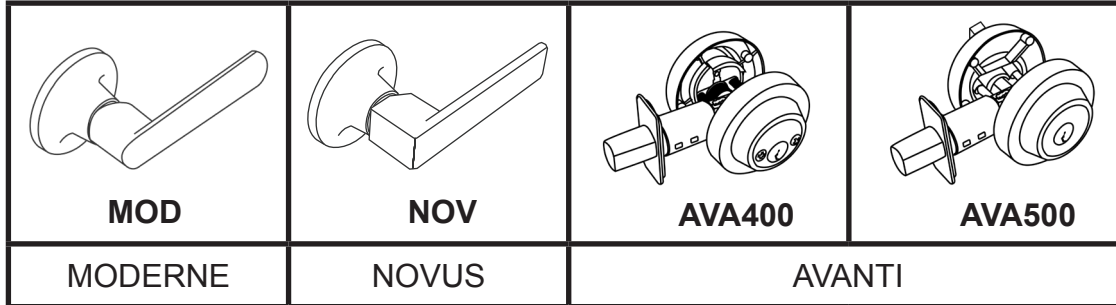

MODERNE ----- MOD SERIES

| FUNCTIONS | ANSI | ITEM # | US11P | US15 | US26 | US26D | US3 | US5 | US15A | PCS / MC |
|--------------------|------|--------|--|------|------|-------|-----|-----|-------|----------|
| Entry - KA / 3 | F109 | MOD-00 | For pricing & availability inquiries contact your Local Distributor or click here for the list of our Sales Reps | | | | | | | 20 |
| Storeroom - KA / 3 | F86 | MOD-05 | | | | | | | | |
| Privacy | F76 | MOD-20 | | | | | | | | |
| Passage | F75 | MOD-30 | | | | | | | | |
| Active Dummy | ---- | MOD-40 | | | | | | | | 36 |

 Prefix "UL" before Part # when ordering UL Listed, available on Entrance and Passage functions.

NOVUS ----- NOV SERIES

| FUNCTIONS | ANSI | ITEM # | US11P | US15 | US26 | US26D | US3 | US5 | US15A | PCS / MC |
|--------------------|------|--------|--|------|------|-------|-----|-----|-------|----------|
| Entry - KA / 3 | F109 | NOV-00 | For pricing & availability inquiries contact your Local Distributor or click here for the list of our Sales Reps | | | | | | | 20 |
| Storeroom - KA / 3 | F86 | NOV-05 | | | | | | | | |
| Privacy | F76 | NOV-20 | | | | | | | | |
| Passage | F75 | NOV-30 | | | | | | | | |
| Active Dummy | ---- | NOV-40 | | | | | | | | 36 |

 Prefix "UL" before Part # when ordering UL Listed, available on Entrance and Passage functions.

AVANTI ----- AVA SERIES

| FUNCTIONS | ANSI | ITEM # | US11P | US15 | US26 | US26D | US3 | US5 | US15A | PCS / MC |
|-----------------------------------|-------|--------|--|------|------|-------|-----|-----|-------|----------|
| Single Cylinder Deadbolt - KA / 3 | E0153 | AVA500 | For pricing & availability inquiries contact your Local Distributor or click here for the list of our Sales Reps | | | | | | | 36 |
| Double Cylinder Deadbolt - KA / 3 | E0143 | AVA400 | | | | | | | | |

► **LEVERSET PACKAGING INCLUDES**

- Kwikset rekeyable 5 pin cylinder
- **6-way** 2 3/8" or 2 3/4" adjustable backset, size 1" x 2 1/4" round corner standard. Square corner option and drive-in latchbolt also available on special factory order.
- Round Corner Full Lip Strike: 1 3/4" x 2 1/4"
- Keyed entry comes with lever / lever for exterior and interior
- 1" bore diameter for latch, 2 1/8" diameter for lock housing

► **DEADBOLT PACKAGING INCLUDES:**

- Kwikset rekeyable 5 pin cylinder
- **6-way** 2 3/8" or 2-3/8" or 2 3/4" adjustable backset, size 1" x 2 1/4" round corner standard, convertible to drive in latch
- Full 1" throw deadbolt
- 1" x 2 1/4" round corner strike standard

ITALIA Series

STAINLESS STEEL LOCKSETS, KNOBSETS, ESCUTCHEONS, ANSI STANDARD A156.2, GRADE 3 OPTIONAL GRADE 2

| HOW TO ORDER | | | | | |
|---|--|--|---|-------------------------------------|--|
| ddd-FFb-[H]R US32X | | | | | |
| DESIGN (ddd) | FUNCTION (FF) | BACKSET (b) | HANDING (H) | ROSE (R) | FINISH (US32X) |
| See Lever / Knob Designs in the table below | 00 - Entrance 20 - Privacy 30 - Passage 40 - Single Dummy | 8 - 2 3/8" (standard) 4 - 2 3/4" 2 - Gr. 2 (Passage) 2H - Gr 2 (L / R - Privacy) 2V - Gr. 2 (RHR/LHR -Privacy) | L - Left Hand R - Right Hand SPECIFY for Handed Levers or Scudo Privacy | G - Giro Q - Quadro S - Scudo | US32D - Satin SS US32 - Polished SS |

ROSE DESIGNS



| LEVER DESIGNS | FUNCTION + 2 3/8" BACKSET STD | | HANDING | ROSE DESIGN | | | | | | PCS / MC | | UPGRADE TO GRADE 2 | |
|--|-------------------------------|----|---------|------------------|--|------------|------|----------------|------|----------|----|--------------------|--|
| | | | | G (ROUND) | | Q (SQUARE) | | S (ESCUTCHEON) | | Q | S | | |
| | | | | US32D | US32 | US32D | US32 | US32D | US32 | G | S | | |
| LUCCA - LUC TURIN - TUR FERRARA - FER RAVENA - RAV *PISA - PIS | ENTRANCE w/ deadbolt | 00 | 8 | L / R *Handed | For pricing & availability inquiries contact your Local Distributor or click here for the list of our Sales Reps | | | | | | 24 | 6 | For pricing & availability inquiries contact your Local Distributor or click here for the list of our Sales Reps |
| PRIVACY | 20 | 8 | 36 | | | | | | | | | | |
| PASSAGE | 30 | 8 | | | | | | | | | | | |
| DUMMY (SINGLE) | 40 | | | | | | | | | | | | |



| LEVER DESIGNS | FUNCTION + 2 3/8" BACKSET STD | | HANDING | ROSE DESIGN | | | | | | PCS / MC | | UPGRADE TO GRADE 2 | |
|--|-------------------------------|----|---------|-------------|--|------------|------|----------------|------|----------|----|--------------------|--|
| | | | | G (ROUND) | | Q (SQUARE) | | S (ESCUTCHEON) | | Q | S | | |
| | | | | US32D | US32 | US32D | US32 | US32D | US32 | G | S | | |
| PERUVIA - PER VENICE - VEN SALERNO - SAL POMPEI - POM SYRACUSE - SYR | ENTRANCE w/ deadbolt | 00 | 8 | Non-handed | For pricing & availability inquiries contact your Local Distributor or click here for the list of our Sales Reps | | | | | | 24 | 6 | For pricing & availability inquiries contact your Local Distributor or click here for the list of our Sales Reps |
| PRIVACY | 20 | 8 | 36 | | | | | | | | | | |
| PASSAGE | 30 | 8 | | | | | | | | | | | |
| DUMMY (SINGLE) | 40 | | | | | | | | | | | | |



"Specify Handing when ordering Privacy function with Scudo rose design"

ROSE DESIGNS

ITALIA Series

STAINLESS STEEL LOCKSETS, KNOBSETS, ESCUTCHEONS, ANSI STANDARD A156.2, GRADE 3 OPTIONAL GRADE 2



| LEVER DESIGNS | FUNCTION + 2 3/8" BACKSET STD | | | | HANDING | ROSE DESIGN | | | | | | PCS / MC | | UPGRADE TO GRADE 2 |
|---|-------------------------------|----|---|------------------|--|-------------|------|------------|------|----------------|------|----------|--|--------------------|
| | | | | | | G (ROUND) | | Q (SQUARE) | | S (ESCUTCHEON) | | Q | S | |
| | | | | | | US32D | US32 | US32D | US32 | US32D | US32 | G | S | |
| SOLID LEVER DESIGNS *SIENA - SIE *LIVORNO - LIV *VICENZA - VIC BRESCIA - BRE | ENTRANCE w/ deadbolt | 00 | 8 | L / R *Handed | For pricing & availability inquiries contact your Local Distributor or click here for the list of our Sales Reps | | | | | | 24 | 6 | For pricing & availability inquiries contact your Local Distributor or click here for the list of our Sales Reps | |
| | PRIVACY | 20 | 8 | | | | | | | | | | | |
| | PASSAGE | 30 | 8 | | | | | | | | | | | |
| | DUMMY (SINGLE) | 40 | | | | | | | | | | | | |



| LEVER DESIGNS | FUNCTION + 2 3/8" BACKSET STD | | | | HANDING | ROSE DESIGN | | | | | | PCS / MC | | UPGRADE TO GRADE 2 |
|--|-------------------------------|----|---|------------|--|-------------|------|------------|------|----------------|------|----------|--|--------------------|
| | | | | | | G (ROUND) | | Q (SQUARE) | | S (ESCUTCHEON) | | Q | S | |
| | | | | | | US32D | US32 | US32D | US32 | US32D | US32 | G | S | |
| KNOB DESIGNS PADERNO - PAD PALERMO - PAL PAVIA - PAV | ENTRANCE w/ deadbolt | 00 | 8 | Non-handed | For pricing & availability inquiries contact your Local Distributor or click here for the list of our Sales Reps | | | | | | 24 | 6 | For pricing & availability inquiries contact your Local Distributor or click here for the list of our Sales Reps | |
| | PRIVACY | 20 | 8 | | | | | | | | | | | |
| | PASSAGE | 30 | 8 | | | | | | | | | | | |
| | DUMMY (SINGLE) | 40 | | | | | | | | | | | | |

► **STANDARD PACKAGING INCLUDES**

GIRO AND QUADRO ROSE STYLE LEVERSETS / KNOBSETS

- Non-handed 2 3/8" backset (2 1/4" x 1") square corner, standard
- Full lip strike round corner 1/4" radius, T-Strike, 1 1/8" x 2" square corner

SCUDO ESCUTCHEON STYLE

- Schlage "C" 5-pin cylinder on deadbolt (Entrance Function)
- Non-handed 2 3/8" backset (2 1/4" x 1") square corner, standard
- Full lip strike round corner 1/4" radius, T-Strike, 1 1/8" x 2" square corner

► **OPTIONS**

- Optional 2 3/4" backset and 4-way, Adjustable Grade 2 Drive-in latch bolt
- See PARTS and ACCESSORIES on page L94

****Specify Handing when ordering Privacy function with Scudo rose design**



- HANDED





- HOLLOW

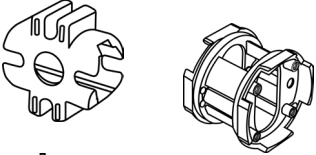
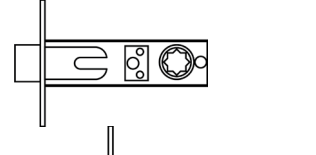
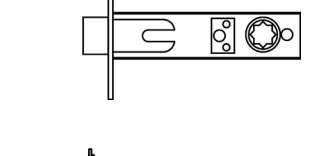
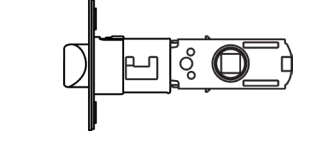
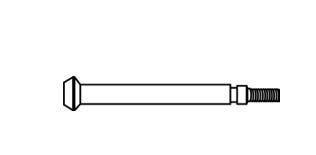
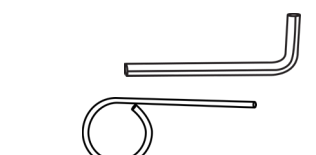
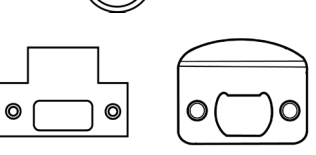
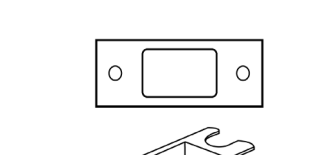
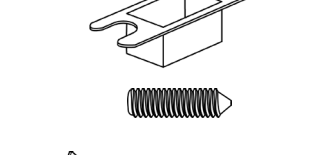
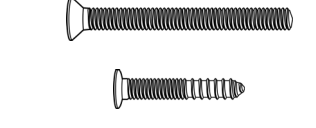

- SOLID

► **ADDITIONAL PARTS FOR ITALIA SERIES**

| ILLUSTRATION | ITEM# | DESCRIPTION | UOM | |
|---|----------------|--|------|--|
|  | APS PVC | Anti-pry Shield PVC material | EACH | For pricing & availability inquiries contact your Local Distributor or click here for the list of our Sales Reps |
|  | APS ZINC | Anti-pry Shield Zinc material | | |
|  | CTPAS238 | Passage 2 3/8" backset (fixed) | | |
|  | CTPRI238 | Privacy 2 3/8" backset (fixed) | | |
|  | CTPAS234 | Passage 2 3/4" backset (fixed) | | |
|  | CTPRI234 | Privacy 2 3/4" backset (fixed) | | |
|  | G2PAS | Grade 2 (4-way) Passage Adjustable 2 3/8" and 2 3/4" backset (non-handed) | | |
|  | G2PRILR | Grade 2 (4-way) Handed Privacy Adjustable 2 3/8" and 2 3/4" backset (L / R). Used for Escutcheon Privacy (SCU) | | |
|  | G2PRIIO | Grade 2 (4-way) Handed Privacy Adjustable 2 3/8" and 2 3/4" backset (LHR / RHR). Used for Escutcheon Privacy (SCU) | | |
|  | CTPRIPIN US32D | Privacy Pin Satin Stainless Steel Finish | | |
|  | CTPRIPIN US32 | Privacy Pin Polished Stainless Steel Finish | | |
|  | ALLENKEY | Allen Key | | |
| | EMRELPIN | Emergency Release Pin | | |
| | TS | T-Strike | | |
| | FLS | Full Lip Strike | | |
| | ITA-FP US32D | Latch Face Plate Italia Series | | |
| | ITA-FP US32 | Latch Face Plate Italia Series | | |
| | ITA-SB | Plastic Strike Box Italia Series | | |
| | ITA-SETSCREW | M4 x 0.7 Lever / Knob set screws Italia Series | | |
| | ITA-SCREWPACK | 8-32 x 1 1/2" Screws for lock body Italia Series (PAIR) | | |
| | ITA-COMBISCREW | 8-32 x 1" Combination metal-wood screws Italia Series (PAIR) | | |

ITALIA Series

STAINLESS STEEL MORTISE LOCKS, ANSI STANDARD A156.2, GRADE 1

| FUNCTIONS | ANSI | FINISH | | PCS / MC |
|--|-------------|--|------|----------|
| | | US32D | US32 | |
| ◀Single cylinder without deadbolt | | | | |
| NM8050 - Office / Entrance | F04 | For pricing & availability inquiries contact your Local Distributor or click here for the list of our Sales Reps | | 6 |
| NM8070 - Classroom | F05 | | | |
| NM8080 - Storeroom | F07 | | | |
| ◀Single cylinder with deadbolt | | | | |
| NM8453 - Entrance | F20 | For pricing & availability inquiries contact your Local Distributor or click here for the list of our Sales Reps | | 6 |
| NM8456 - Corridor | F13 | | | |
| NM8495 - Keyed Privacy w/ Indicator | ---- | | | |
| NM8465 - Closet / Storeroom | ---- | | | |
| NM8473 - Dormitory / Bedroom | F21 | | | |
| ◀Double cylinder without deadbolt | | | | |
| NM8060 - Apartment Entrance | F09 | For pricing & availability inquiries contact your Local Distributor or click here for the list of our Sales Reps | | 6 |
| NM8082 - Institution | F30 | | | |
| ◀Double cylinder with deadbolt | | | | |
| NM8466 - Storeroom | F14 | | | |
| ◀Other Functions | | | | |
| NM8040 - Privacy with Deadbolt | F02,F19,F22 | For pricing & availability inquiries contact your Local Distributor or click here for the list of our Sales Reps | | 6 |
| NM8445 - Privacy with Indicator | ---- | | | |
| NM8010 - Passage | F01 | | | |

 All keyed lock functions are available with **Best, Falcon and Arrow, Schlage, Corbin / Russwin, Sargent, and Yale Large Format Interchangeable Cores.**

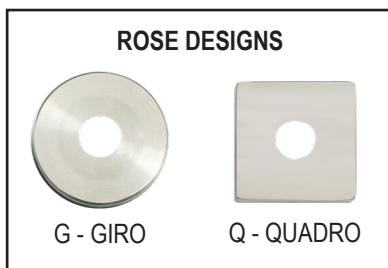

ORDERING FOR NM SERIES MORTISE LOCK

The Lever and Knob designs can also be used for our NM Series Mortise Locks. To order, refer to functions in the NM Series page and choose a function, indicate handing, lever / knob design, rose design (G or Q) and finish: **NMnnnnHH-ddd-r US32x**
e.g. :

To order NM8080 function LH in SIENA lever design with round rose in US32D finish use:

NM8080LH-SIE-G US32D

ITALIA Series

STAINLESS STEEL DEADBOLTS WITH GRADE 1 LATCH

ANSI STANDARD A156.2, GRADE 3

- ▶ KEYWAY standard 5-PIN SCHLAGE "C"
 - Latch Bolt: Grade 1, 4-way Drive-In, Brass, Satin Nickel bolt
 - Latch Backset: Adjustable 2 3/8 (60) and 2 3/4 (70)
 - Handing: Non-Handed
 - Latch Faceplate: 1" x 2 1/4" (25 x 57)
 - Deadbolt Strike: 1 1/8" x 2 3/4" (29 x 70) square corner (standard)
 - Security Strike: 1 1/8" x 2 3/4" x 3/32" (29 x 70 x 2) (standard)
 - Keying service available

▶ DEADBOLT DESIGNS

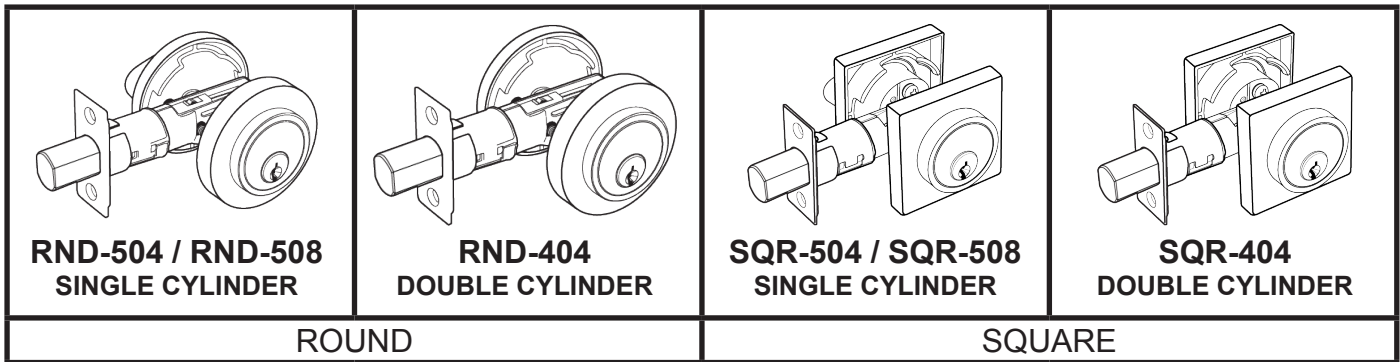

DEADBOLT ----- ITALIA SERIES

| FUNCTIONS | ANSI | ITEM # | US32D | US32 | PCS / MC |
|---|-------|---------|--|------|----------|
| Single Cylinder Round Deadbolt for 1 3/4" Door Thickness | E0153 | RND-504 | For pricing & availability inquiries contact your Local Distributor or click here for the list of our Sales Reps | | 18 |
| Single Cylinder Round Deadbolt for 1 5/8" Door Thickness | E0153 | RND-508 | | | |
| Single Cylinder Square Deadbolt for 1 3/4" Door Thickness | E0153 | SQR-504 | | | |
| Single Cylinder Square Deadbolt for 1 5/8" Door Thickness | E0153 | SQR-508 | | | |
| Double Cylinder Round Deadbolt for 1 3/4" Door Thickness | E0143 | RND-404 | | | |
| Double Cylinder Square Deadbolt for 1 3/4" Door Thickness | E0143 | SQR-404 | | | |

HERITAGE Series

RESIDENTIAL LEVERS AND DEADBOLTS

ANSI STANDARD A156.2, GRADE 3

► **KEYWAYS** (STD, "KW" 5-PIN KWIKSET) OPTIONAL 5-PIN SCHLAGE "C" & WEISER

- All locksets and deadbolts are available with **Schlage "C"** and **Weiser** keyway on special factory order only. Consult factory
- **SCHLAGE "C" KEYWAY OPTION:** Prefix "C" before Part # (Ex: AZU-00 with C keyway is CAZU-00)
- **WEISER KEYWAY OPTION:** Prefix "W" before Part # (Ex: AZU-00 with Weiser keyway is WAZU-00)

► **LEVERSET DESIGNS**

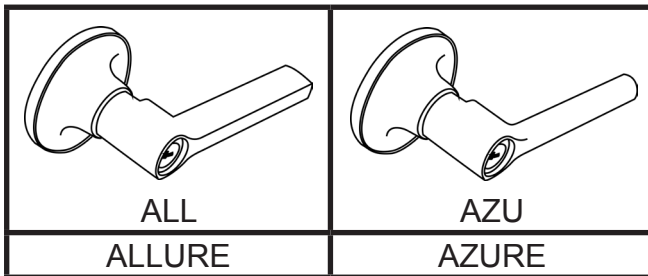

AZURE ----- AZU SERIES

| FUNCTIONS | ANSI | ITEM # | US3 | US5 | US11P | US15 | US15A | US26 | US26D | PCS / MC | |
|--------------------|------|--------|---|-----|-------|------|-------|------|-------|----------|----|
| Entry - KA / 3 | F109 | AZU-00 | For pricing & availability inquiries contact your Local Distributor or click here for the list of our Sales Reps | | | | | | | | 24 |
| Storeroom - KA / 3 | F86 | AZU-05 | | | | | | | | | |
| Privacy | F76 | AZU-20 | | | | | | | | | |
| Passage | F75 | AZU-30 | | | | | | | | | |
| Active Dummy | ---- | AZU-40 | | | | | | | | | |
| | | | | | | | | | | 36 | |

 Prefix "UL" before Part # when ordering UL Listed, available on Entrance and Passage functions.

ALLURE ----- ALL SERIES

| FUNCTIONS | ANSI | ITEM # | US3 | US5 | US11P | US15 | US15A | US26 | US26D | PCS / MC | |
|--------------------|------|--------|---|-----|-------|------|-------|------|-------|----------|----|
| Entry - KA / 3 | F109 | ALL-00 | For pricing & availability inquiries contact your Local Distributor or click here for the list of our Sales Reps | | | | | | | | 24 |
| Storeroom - KA / 3 | F86 | ALL-05 | | | | | | | | | |
| Privacy | F76 | ALL-20 | | | | | | | | | |
| Passage | F75 | ALL-30 | | | | | | | | | |
| Active Dummy | ---- | ALL-40 | | | | | | | | | |
| | | | | | | | | | | 36 | |

 Prefix "UL" before Part # when ordering UL Listed, available on Entrance and Passage functions.

► **LEVERSET PACKAGING INCLUDES**

- Kwikset rekeyable 5-pin cylinder
- 2 3/8" or 2 1/4" adjustable backset, size 1" x 2 1/4" round corner standard
Square corner option and drive-in latchbolt also available on special factory order
- Round Corner Full Lip Strike: 1 3/4" x 2 1/4"
- Keyed entry comes with lever / lever for exterior and interior
- 1" bore diameter for latch, 2 1/8" diameter for lock housing

5 Year Finish Warranty
25 Year Mechanical Warranty

LEGACY Series

RESIDENTIAL LEVERS A156.2, GRADE 3

► **KEYWAYS (STD, "KW" 5-PIN KWIKSET) OPTIONAL 5-PIN SCHLAGE "C" & WEISER**

- All locksets and deadbolts are available with **Schlage "C"** and **Weiser** keyway on special factory order, or from stock. See below.
- **SCHLAGE "C" KEYWAY OPTION:** Prefix "C" before Part # (Ex: ZUL00 with C keyway is CZUL00)
- **WEISER KEYWAY OPTION:** Prefix "W" before Part # (Ex: ZUL00 with Weiser keyway is WZUL00)
- Prefix "UL" before Part # when ordering UL Listed, available on Entrance, Storeroom, Privacy, Passage and Deadbolt functions.

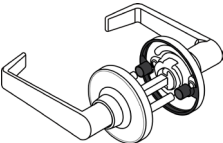

CABERNET ----- CAB DESIGN

|  | FUNCTIONS | ANSI | ITEM # | US15 | US26D | US11P | US5 | 15A / 26 | US3 | PCS / MC | |
|--|-------------------------|------|--------|--|-------|-------|-----|----------|-----|----------|----|
| | Entrance w/ Push Button | F109 | CAB00 | For pricing & availability inquiries contact your Local Distributor or click here for the list of our Sales Reps | | | | | | | 24 |
| | Storeroom | F86 | CAB05 | | | | | | | | 24 |
| | Privacy w/ Push Button | F76 | CAB20 | | | | | | | | 24 |
| | Passage | F75 | CAB30 | | | | | | | | 24 |
| | Dummy | -- | CAB40 | | | | | | | | 24 |

ZULU ----- ZUL DESIGN

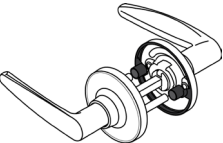
|  | FUNCTIONS | ANSI | ITEM # | US15 | US26D | US11P | US5 | 15A / 26 | US3 | PCS / MC | |
|--|-------------------------|------|--------|--|-------|-------|-----|----------|-----|----------|----|
| | Entrance w/ Push Button | F109 | ZUL00 | For pricing & availability inquiries contact your Local Distributor or click here for the list of our Sales Reps | | | | | | | 24 |
| | Storeroom | F86 | ZUL05 | | | | | | | | 24 |
| | Privacy w/ Push Button | F76 | ZUL20 | | | | | | | | 24 |
| | Passage | F75 | ZUL30 | | | | | | | | 24 |
| | Dummy | -- | ZUL40 | | | | | | | | 24 |

DUCATI ----- DUC DESIGN

|  | FUNCTIONS | ANSI | ITEM # | US15 | US26D | US11P | US5 | 15A / 26 | US3 | PCS / MC | |
|--|-------------------------|------|--------|--|-------|-------|-----|----------|-----|----------|----|
| | Entrance w/ Push Button | F109 | DUC00 | For pricing & availability inquiries contact your Local Distributor or click here for the list of our Sales Reps | | | | | | | 24 |
| | Storeroom | F86 | DUC05 | | | | | | | | 24 |
| | Privacy w/ Push Button | F76 | DUC20 | | | | | | | | 24 |
| | Passage | F75 | DUC30 | | | | | | | | 24 |
| | Dummy | -- | DUC40 | | | | | | | | 24 |

NAPA ----- NAP DESIGN

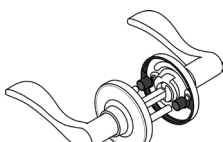
|  | FUNCTIONS | ANSI | ITEM # | US15 | US26D | US11P | US5 | 15A/26 | US3 | PCS / MC | |
|--|-----------------------------|------|--------|--|-------|-------|-----|--------|-----|----------|----|
| | Entrance w/ Push Button *SH | F109 | NAP00 | For pricing & availability inquiries contact your Local Distributor or click here for the list of our Sales Reps | | | | | | | 24 |
| | Storeroom *SH | F86 | NAP05 | | | | | | | | 24 |
| | Privacy w/ Push Button *SH | F76 | NAP20 | | | | | | | | 24 |
| | Passage *SH | F75 | NAP30 | | | | | | | | 24 |
| | Dummy *SH | -- | NAP40 | | | | | | | | 24 |

*SH is for Specify Handing

DENMARK ----- DEN DESIGN

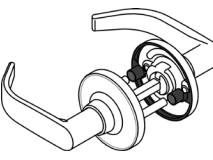
|  | FUNCTIONS | ANSI | ITEM # | US15 | US26D | US11P | US5 | 15A / 26 | US3 | PCS / MC |
|---|-------------------------|------|--------|--|-------|-------|-----|----------|-----|----------|
| | Entrance w/ Push Button | F109 | DEN00 | For pricing & availability inquiries contact your Local Distributor or click here for the list of our Sales Reps | | | | | | 24 |
| | Storeroom | F86 | DEN05 | | | | | | | 24 |
| | Privacy w/ Push Button | F76 | DEN20 | | | | | | | 24 |
| | Passage | F75 | DEN30 | | | | | | | 24 |
| | Dummy | -- | DEN40 | | | | | | | 24 |

VIARGENTO ----- VIA DESIGN

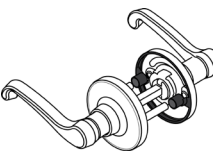
|  | FUNCTIONS | ANSI | ITEM # | US15 | US26D | US11P | US5 | 15A / 26 | US3 | PCS / MC |
|---|-----------------------------|---------|--------|--|-------|-------|-----|----------|-----|----------|
| | Entrance w/ Push Button *SH | F109 | VIA00 | For pricing & availability inquiries contact your Local Distributor or click here for the list of our Sales Reps | | | | | | 24 |
| | Storeroom | *SH F86 | VIA05 | | | | | | | 24 |
| | Privacy w/ Push Button *SH | F76 | VIA20 | | | | | | | 24 |
| | Passage | *SH F75 | VIA30 | | | | | | | 24 |
| | Dummy | *SH -- | VIA40 | | | | | | | 24 |

*SH is for Specify Handing

► LEVERSET PACKAGING INCLUDES

- 2 3/8" or 2 3/4" 4-way adjustable backset, size 1" x 2 1/4" round corner standard, convertible to drive-in latch. Square corner face plate and 5" round corner backsets optional.
- All locksets are packed with full lip strike round corner 1/4" radius
- Screw Guiding Posts for easy screw alignment and tightening making installation fast and easy.
- Push button release on entrance and privacy from inside by turning lever.
- Kwikset rekeyable 5 pin cylinder

CLIPPER Series

RESIDENTIAL DEADBOLTS A156.2, GRADE



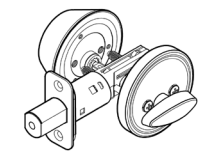
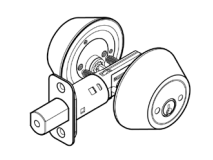
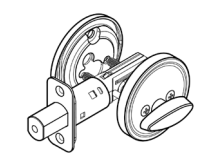
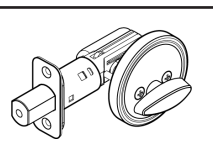



|  | FUNCTIONS | ITEM # | US15 | US26D | US11P | US3 | US5 | PCS / MC |
|---|-------------------------------|--------|--|-------|-------|-----|-----|----------|
| | Single Cylinder Deadbolt | CLP500 | For pricing & availability inquiries contact your Local Distributor or click here for the list of our Sales Reps | | | | | 24 |
|  | Double Cylinder Deadbolt | CLP400 | For pricing & availability inquiries contact your Local Distributor or click here for the list of our Sales Reps | | | | | 24 |
|  | One Sided Deadbolt with Cover | CLP801 | For pricing & availability inquiries contact your Local Distributor or click here for the list of our Sales Reps | | | | | 24 |
|  | One Sided Deadbolt | CLP701 | For pricing & availability inquiries contact your Local Distributor or click here for the list of our Sales Reps | | | | | 24 |

 Optional UL Listed Latch.

► **DEADBOLT PACKAGING INCLUDES:**

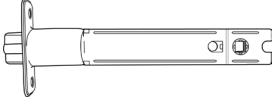
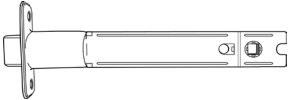
- 2 3/8" or 2 3/4" 4-way adjustable backset, size 1" x 2 1/4" round corner standard, convertible to drive-in latch. Square corner face plate and 5" round corner backsets optional.
- Deadbolts packed with 1" x 2 1/4" strike round corner 1/4" radius and full lip strike 1/4" radius. Square corner available upon request.
- Security strike (1 1/4" x 3 5/8" x 1/4" radius) with 3" screws available.
- Kwikset rekeyable 5 pin cylinder

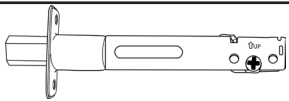
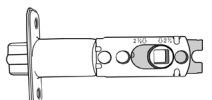
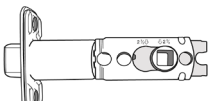
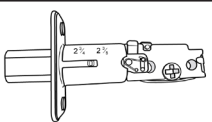
► **ADDITIONAL PARTS FOR VANGUARD, HERITAGE, LEGACY, AND CLIPPER SERIES**

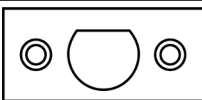
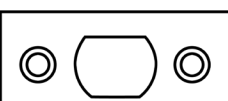
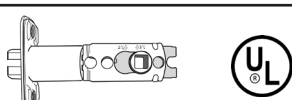
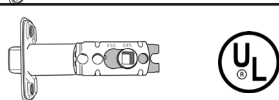
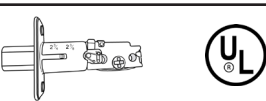
| ILLUSTRATION | ITEM# | DESCRIPTION | |
|---|----------------|--|--|
|  | LGEN-5 US32D | 5" Entrance Deadlatch Round Corner for Legacy Series | For pricing & availability inquiries contact your Local Distributor or click here for the list of our Sales Reps |
| | LGEN-5 US11P | 5" Entrance Deadlatch Round Corner for Legacy Series | |
|  | LGPA-5 US32D | 5" Privacy / Passage Spring Latch Round Corner for Legacy Series | |
| | LGPA-5 US11P | 5" Privacy / Passage Spring Latch Round Corner for Legacy Series | |
|  | LGST-5 US32D | 5" Storeroom Dead Latch Round Corner for Legacy Series | |
| | LGST-5 US11P | 5" Storeroom Dead Latch Round Corner for Legacy Series | |
|  | LGDB-5 US32D | 5" Deadbolt Latch Round Corner for Legacy Series | |
| | LGDB-5 US11P | 5" Deadbolt Latch Round Corner for Legacy Series | |
|  | LGEN-1 US32D | Adjustable Entrance 4-Way Dead Latch 2 3/8" or 2 3/4" Round Corner w/ Drive-in Collar for Legacy Series | |
| | LGEN-1 US11P | Adjustable Entrance 4-Way Dead Latch 2 3/8" or 2 3/4" Round Corner w/ Drive-in Collar for Legacy Series | |
|  | LGPA-3 US32D | Adjustable Privacy / Passage 4-Way Spring Latch 2 3/8" or 2 3/4" Round Corner w/ Drive-in Collar for Legacy Series | |
| | LGPA-3 US11P | Adjustable Privacy / Passage 4-Way Spring Latch 2 3/8" or 2 3/4" Round Corner w/ Drive-in Collar for Legacy Series | |
|  | LGDB-2 US32D | Adjustable 4-Way Deadbolt Latch 2 3/8" or 2 3/4" Round Corner w/ Drive-in Collar for Legacy Series | |
| | LGDB-2 US11P | Adjustable 4-Way Deadbolt Latch 2 3/8" or 2 3/4" Round Corner w/ Drive-in Collar for Legacy Series | |
|  | LGSCEN-9 US32D | Square Corner Faceplate for Storeroom / Entrance Legacy Series | |
| | LGSCEN-9 US11P | Square Corner Faceplate for Storeroom / Entrance Legacy Series | |
|  | LGSCPP-8 US32D | Square Corner Faceplate for Privacy / Passage Legacy Series | |
| | LGSCPP-8 US11P | Square Corner Faceplate for Privacy / Passage Legacy Series | |
|  | LGSCDB-7 US32D | Square Corner Faceplate for Deadbolt Legacy Series | |
| | LGSCDB-7 US11P | Square Corner Faceplate for Deadbolt Legacy Series | |
|  | ULLGEN-1 | UL-Listed Adjustable Dead Latch 2 3/8" or 2 3/4" with round corner faceplate for Entrance and Storeroom Leversets | |
|  | ULLGPAS-3 | UL-Listed Adjustable Spring Latch 2 3/8" or 2 3/4" with round corner faceplate for Privacy and Passage Leversets | |
|  | ULLGDB-2 | UL-Listed Adjustable Deadbolt Latch 2 3/8" or 2 3/4" for Deadbolts | |

► **ADDITIONAL PARTS FOR VANGUARD, HERITAGE, LEGACY, AND CLIPPER SERIES**

| ILLUSTRATION | ITEM# | DESCRIPTION | |
|----------------------|--------------------------|---|--|
| | TS | T-Strike | For pricing & availability inquiries contact your Local Distributor or click here for the list of our Sales Reps |
| | FLS | Full Lip Strike | |
| | DBFLS | Deadbolt Full Lip Strike, Round Corner | |
| | ASAST US3, 26D, 26 | ANSI ASA Strike | |
| | ASAST US3, 26D, 26 | ANSI ASA Strike | |
| | EXASA-175 US32D, DURO | Extended Lip ANSI Strike 1 3/4" Lip Extension from Screw Center Line | |
| | SS114358 | Security Strike 1 1/4" x 3 5/8", 1/4" Rad With 2pcs each of 3" and 1 1/4" Screws US3, 5, 25, 26D, 10B | |
| | K1-KEY | Blank Keys K1 | |
| | KEYS | Extra Cut Keys | |
| | LFA18 | Latch Front Adapter To Convert 1" Faceplate To 1 1/8" Wide Door Preparation | |
| | PDBFLS | Plastic Dust box for Full Lip Strike | |
| | PDB1214 | Plastic Dust box for Residential Deadbolt Strike 1" x 2 1/4" | |
| | PDB118234 | Plastic Dust box for T-Strike 1 1/8" x 2 3/4" | |
| | PDBTS | Plastic Dust box for Deadbolt T2STRK Strike | |
| | PDB478 | Plastic Dust box for ASA Strike | |
| ◆ KEYING KITS | | | |
| | KKWI200 | Keying Kit - KWI Keyway | |
| ◆ MOUNT | | | |
| | RESMOUNT | 3 Hole Mount For Residential Locks | |

| KEYING | | |
|--------|---|--|
| ITEM # | DESCRIPTION | |
| KARES | Key alike | For pricing & availability inquiries contact your Local Distributor or click here for the list of our Sales Reps |
| MKRES | Master key (Including KA) | |
| CMKRES | Builder construction master key (Including KA & MK) | |
| GMKRES | Grand master key (Including KA, MK) | |

REPLACEMENT CYLINDERS . . .

- Made to Original Manufacturers' Keying Specifications
- All Cylinders drilled for 6-pins
- Can be keyed with original pins
- Packed with appropriate accessories

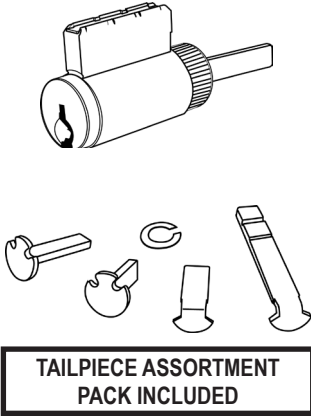
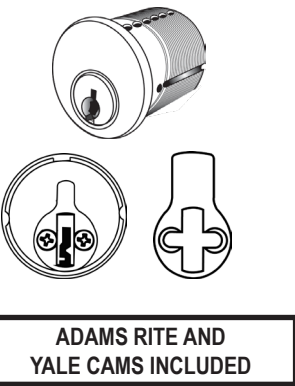
| ILLUSTRATION | ITEM# | DESCRIPTION | KEYED | FINISH |
|---|---------|-------------------------------------|-------|--|
| KEY-IN-KNOB/LEVER & DEADBOLT CYLINDER (Packed with tailpiece assortment pack) | | | | |
|  <p>TAILPIECE ASSORTMENT PACK INCLUDED</p> | KKARA-4 | 6-pin Arrow "A" | 5-pin | For pricing & availability inquiries contact your Local Distributor or click here for the list of our Sales Reps |
| | KKC59-4 | 6-pin Corbin 60 Russwin 59 | 5-pin | |
| | KKCL4-4 | 6-pin Corbin L1 thru L4 | 6-pin | |
| | KKKW5-4 | 6-pin Kwikset | 5-pin | |
| | KKRD1-4 | 6-pin Russwin D-1 thru 4 | 6-pin | |
| | KKSCC-4 | 6-pin Schlage "C" | 6-pin | |
| | KKSCE-4 | 6-pin Schlage "E" | 6-pin | |
| | KKSCF-4 | 6-pin Schlage "F" | 6-pin | |
| | KKSCP-4 | 6-pin Schlage C-K | 5-pin | |
| | KKSLA-4 | 6-pin Sargent "LA" thru "LC" | 6-pin | |
| | KKSRA-4 | 6-pin Sargent "RA" | 6-pin | |
| | KKWFE-4 | 6-pin Weiser / Falcon "E" | 5-pin | |
| | KKYA8-4 | 6-pin Yale 8 (E1R) | 5-pin | |
| | KKYGA-4 | 6-pin Yale "GA" | 6-pin | |
| 1-1/4" MORTISE CYLINDERS (Packed with Adams Rite and Yale Cams) | | | | |
|  <p>ADAMS RITE AND YALE CAMS INCLUDED</p> | KMARA-4 | 6-pin Arrow "A" | 5-pin | For pricing & availability inquiries contact your Local Distributor or click here for the list of our Sales Reps |
| | KMC59-4 | 6-pin Corbin 60 Russwin 59 | 5-pin | |
| | KMCL4-4 | 6-pin Corbin L1 thru L4 | 6-pin | |
| | KMKW5-4 | 6-pin Kwikset | 5-pin | |
| | KMRD1-4 | 6-pin Russwin D-1 thru 4 | 6-pin | |
| | KMSCC-4 | 6-pin Schlage "C" | 6-pin | |
| | KMSCE-4 | 6-pin Schlage "E" | 6-pin | |
| | KMSCF-4 | 6-pin Schlage "F" | 6-pin | |
| | KMSCP-4 | 6-pin Schlage C-K | 5-pin | |
| | KMSLA-4 | 6-pin Sargent "LA" thru "LC" | 6-pin | |
| | KMSRA-4 | 6-pin Sargent "RA" | 6-pin | |
| | KMWFE-4 | 6-pin Weiser / Falcon "E" | 5-pin | |
| | KMYA8-4 | 6-pin Yale 8 (E1R) | 5-pin | |
| | KMYGA-4 | 6-pin Yale "GA" | 6-pin | |

REPLACEMENT CYLINDERS . . .

- Made to Original Manufacturers' Keying Specifications
- All Cylinders drilled for 6-pins
- Can be keyed with original pins
- Packed with appropriate accessories

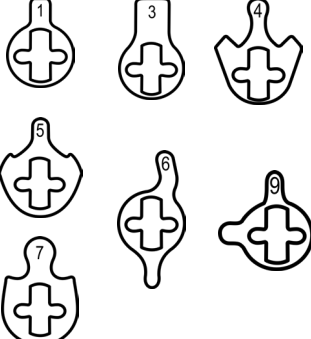
| ILLUSTRATION | ITEM# | DESCRIPTION | KEYED | FINISH |
|---|-------|--|-------|--|
| MORTISE CYLINDER CAMS | | | | |
|  | KC-S1 | Mortise Cylinder Adams Rite Cam | | For pricing & availability inquiries contact your Local Distributor or click here for the list of our Sales Reps |
| | KC-S3 | Mortise Cylinder Yale Mortise Lock Cam | | |
| | KC-S4 | Mortise Cylinder Russwin Mortise Lock Cam | | |
| | KC-S5 | Mortise Cylinder Falcon Mortise Lock Cam | | |
| | KC-S6 | Mortise Cylinder Cal-Royal Panic Trim Cam | | |
| | KC-S7 | Mortise Cylinder CRP Mortise Lock -- (NM Series) | | |
| | KC-S9 | Mortise Cylinder NESC Panic Trim | | |
| | | | | --- |

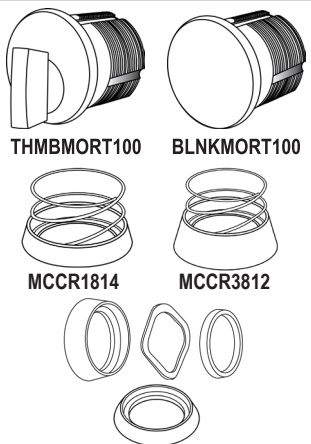
| MORTISE CYLINDER ACCESSORIES | | | | |
|--|-------------|---|--|-------------------|
|  | THMBMORT100 | 1" Mortise Cylinder with Thumbturn | | US26D |
| | BLNKMORT100 | 1" Blank Mortise Cylinder | | US10B,3 |
| | MCCR1814 | Mortise Cylinder Compression Ring 1/8" to 1/4" | | US26D |
| | MCCR3812 | Mortise Cylinder Compression Ring 3/8" to 1/2" | | US10B,3 |
| | CGR175 | Cylinder Guard Ring 1 3/4" base and 1/2" projection with Wave Washer and Spacing Collar | | US3, US10B, US26D |
| | MCRC250 | Free Spinning Cylinder Guard Ring 1/4" | | US26D, 10B, 3, 4 |
| | | | | US3, 15, 26D, 10B |

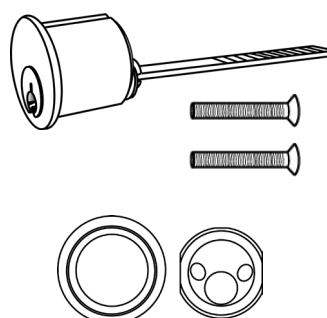
| ILLUSTRATION | ITEM# | DESCRIPTION | KEYED | FINISH |
|---|---------|-------------------------------|-------|--|
| RIM CYLINDERS | | | | |
|  <div style="border: 1px solid black; padding: 5px; width: fit-content; margin-top: 10px;"> MOUNTING PLATE AND SCREWS INCLUDED </div> | KR-AR-A | Arrow "A" | 5-pin | For pricing & availability inquiries contact your Local Distributor or click here for the list of our Sales Reps |
| | KR-C-59 | Corbin 60 Russwin 59 | 5-pin | |
| | KR-C-L4 | Corbin L1 thru L4 | 6-pin | |
| | KR-KW-5 | Kwikset | 5-pin | |
| | KR-R-D1 | Russwin D-1 thru 4 | 6-pin | |
| | KR-SC-C | Schlage "C" | 6-pin | |
| | KR-SC-E | Schlage "E" | 6-pin | |
| | KR-SC-F | Schlage "F" | 6-pin | |
| | KR-SC-P | Schlage C-K | 5-pin | |
| | KR-S-LA | Sargent "LA" thru "LC" | 6-pin | |
| | KR-S-RA | Sargent "RA" | 6-pin | |
| | KR-WF-E | Weiser / Falcon "E" | 5-pin | |
| | KR-YA-8 | Yale 8 (E1R) | 5-pin | |
| | KR-Y-GA | Yale "GA" | 6-pin | |
| | | | | US26D |

RIM AND MORTISE CYLINDERS

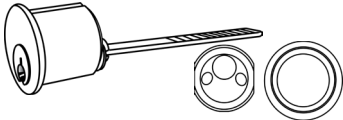
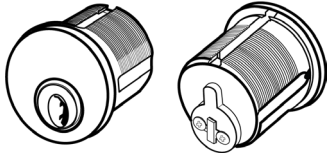
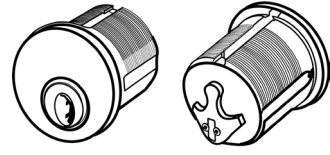
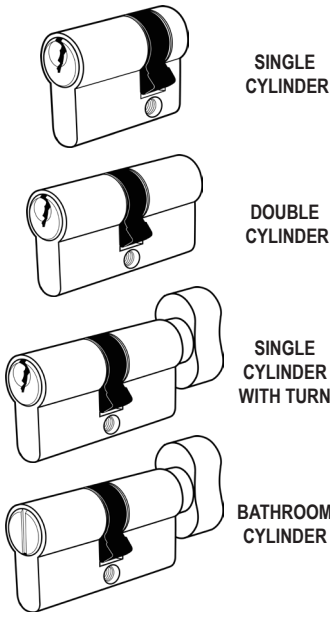
| 6-pin SCHLAGE "C" KEYWAY MORTISE AND RIM CYLINDERS | | | |
|---|-------------|--|---------|
| ILLUSTRATION | ITEM # | DESCRIPTION | FINISH |
|  | CX96RIMKD | 6-pin Schlage "C" keyway 1 1/8" Rim Cylinder with mounting plate & screws | US26D |
| | | | US10B,3 |
|  | AMORTCYL118 | 6-pin Schlage "C" Keyway Mortise Cylinder 1 1/8" length, with ADAMS RITE cam | US26D |
| | AMORTCYL114 | 6-pin Schlage "C" Keyway Mortise Cylinder 1 1/4" length, with ADAMS RITE cam | US10B,3 |
|  | CMORTCYL118 | 6-pin Schlage "C" Keyway Mortise Cylinder 1 1/8" length, with CLOVER LEAF cam | US26D |
| | CMORTCYL114 | 6-pin Schlage "C" Keyway Mortise Cylinder 1 1/4" length, with CLOVER LEAF cam | US10B,3 |
| 6-pin SCHLAGE "C" KEYWAY EUROPEAN PROFILE MORTISE CYLINDERS | | | |
|  | KE-SCC-S-A | Single Cylinder 45mm Schlage "C", 6-pin rekeyable | US15 |
| | KE-SCC-D-C | Double Cylinder 60mm Schlage "C", 6-pin rekeyable | |
| | KE-SCC-D-D | Double Cylinder 70mm Schlage "C", 6-pin rekeyable | |
| | KE-SCC-C-C | Single Cylinder with turn 60mm Schlage "C", 6-pin rekeyable | |
| | KE-SCC-C-D | Single Cylinder with turn 70mm Schlage "C", 6-pin rekeyable | |
| | KE-P-C | Bathroom Cylinder 60mm | |
| | KE-P-D | Bathroom Cylinder 70mm | |
| EASY REMOVABLE SCREW FOR RE-KEYING | | | |

For pricing & availability inquiries contact your Local Distributor or click [here](#) for the list of our Sales Reps

For pricing & availability inquiries contact your Local Distributor or click [here](#) for the list of our Sales Reps

BEST / FALCON 6 & 7-PIN SMALL FORMAT INTERCHANGEABLE CORES (SFIC) HOUSING & KEY BLANKS

KEY SECTIONS (A, B, C, D, E, F, G, H, J, K, L, M, Q, TB)

*All above keyways in stock for immediate shipment

MEETS
The Buy American Act



Features:

- Operates on Best / Falcon Small Format Interchangeable Cores locksets, deadbolts, rim and Mortise cylinders
- Operates on all of Cal-Royal's keyed locksets prepared for small format Best / Falcon A, B, C, D, E, F, G, H, J, K, L, M, Q, TB keyways

| KEY SECTIONS | UNCOMBINATIONED | US4, US26D | MASTER KEYED | US4, US26D | KEY BLANKS | NICKEL PLATED |
|--------------|------------------|--|--------------------|--|------------|--|
| A B | *6PUC A (6-pins) | For pricing & availability inquiries contact your Local Distributor or click here for the list of our Sales Reps | 6PCCA-MK (6-pins) | For pricing & availability inquiries contact your Local Distributor or click here for the list of our Sales Reps | KBSF-A | For pricing & availability inquiries contact your Local Distributor or click here for the list of our Sales Reps |
| | *7PUC A (7-pins) | | 7PCC A-MK (7-pins) | | KBSF-B | |
| | 7PUC B (7-pins) | | 7PCC B-MK (7-pins) | | KBSF-C | |
| C D | 7PUC C (7-pins) | | 7PCC C-MK (7-pins) | | KBSF-D | |
| | 7PUC D (7-pins) | | 7PCC D-MK (7-pins) | | KBSF-E | |
| E F | 7PUC E (7-pins) | | 7PCC E-MK (7-pins) | | KBSF-F | |
| | 7PUC F (7-pins) | | 7PCC F-MK (7-pins) | | KBSF-G | |
| G H | 7PUC G (7-pins) | | 7PCC G-MK (7-pins) | | KBSF-H | |
| | 7PUC H (7-pins) | | 7PCC H-MK (7-pins) | | KBSF-J | |
| J K L | 7PUC J (7-pins) | | 7PCC J-MK (7-pins) | | KBSF-K | |
| | 7PUC K (7-pins) | | 7PCC K-MK (7-pins) | | KBSF-L | |
| | 7PUC L (7-pins) | | 7PCC L-MK (7-pins) | | KBSF-M | |
| M Q TB | 7PUC M (7-pins) | 7PCC M-MK (7-pins) | KBSF-Q | | | |
| | 7PUC Q (7-pins) | 7PCC Q-MK (7-pins) | KBSF-TB | | | |
| | 7PUC TB (7-pins) | 7PCC TB-MK (7-pins) | | | | |

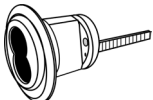
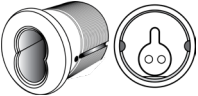
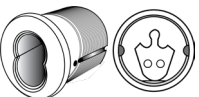
| ILLUSTRATION | ITEM # | DESCRIPTION | FINISH |
|---|-----------|--|---------|
|  | 308-602 | Best / Falcon and Arrow 6 / 7-pin Small Format Interchangeable Core Rim Cylinder with mounting plate & screws | US26D |
| | | | US10B,3 |
|  | 307-601 | Best / Falcon and Arrow 6 / 7-pin Small Format Interchangeable Core Mortise Cylinder, with ADAMS RITE cam, 1 1/4" | US26D |
| | | | US10B,3 |
|  | ICH961387 | Best / Falcon and Arrow 6 / 7-pin Small Format Interchangeable Core Mortise Cylinder, CLOVER LEAF cam 1 1/4" length. To be used with Cal-Royal NM Series mortise locks | US26D |
| | | | US10B,3 |

| ITEM # | CONSTRUCTION CORES |
|--------|--|
| ICCC | Temporary 6-pin construction cores are available. |
| ICCC7 | Temporary 7-pin construction cores are available. |
| ICPTT | Plastic thumb turns available for non-secured areas. |

LARGE FORMAT 6-Pin INTERCHANGEABLE CORE (LFIC) & HOUSING

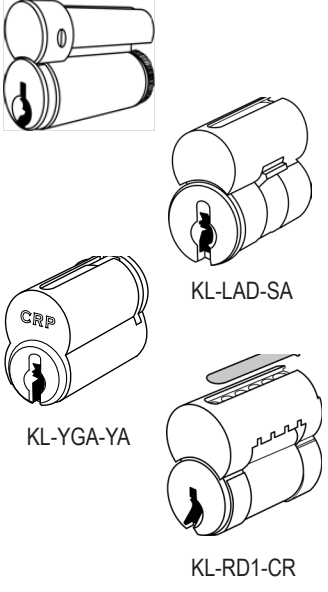
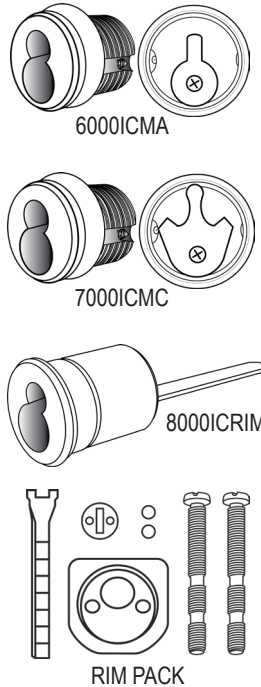

Features:

- Operates on all **Schlage, Sargent, Russwin, Yale Large Format Interchangeable Cores** locksets, deadbolts, rim and Mortise cylinders.
- Operates on Cal-Royal's Commander Grade 2 leversets with large format, Genesys Grade 1 leversets with Large Format IC Core, T220 Series deadbolts with Large Format IC Core.

| ILLUSTRATION | ITEM # | DESCRIPTION | FINISH | | |
|---|------------|--|-------------------------|--|-------|
|  | 3000 ICC | 6-pin "C" keyway combined Schlage large format IC core cylinder KA# 111111 with "C" keys | US3, US26D | For pricing & availability inquiries contact your Local Distributor or click here for the list of our Sales Reps | |
| | 4000ICCK | 6-pin "C-K" keyway combined Schlage large format IC core cylinder KA# 111111 with "E" keys | | | |
| | 5000ICE | 6-pin "E" keyway combined Schlage large format IC core cylinder KA# 111111 with "E" keys | | | |
| | 1000ICC | 6-pin "C" keyway combined Schlage large format IC core cylinder KD and MK | | | |
| | 2000 ICC | Temporary 6-pin Schlage large format IC Core Construction Cores (Keyed Alike) . | | | |
| | KL-LAD-SA | Sargent LA-LB-LC LFIC 6-pin Uncombined | | | US26D |
| | KL-RD1-CR | Corbin / Russwin D1-D4 LFIC 6-pin Uncombined | | | US26D |
| | KL-YGA-YA | YALE GA LFIC 6-pin Uncombined | | | US26D |
| LARGE FORMAT 6-pin INTERCHANGEABLE CORE MORTISE AND RIM CYLINDERS | | | | | |
|  | 6000ICMA | Schlage Large Format Interchangeable Core Mortise Cylinder with Adams Rite Cam 1 1/2" long | US3, US10B, US26D | For pricing & availability inquiries contact your Local Distributor or click here for the list of our Sales Reps | |
| | 7000ICMC | Schlage Large Format Interchangeable Core Mortise Cylinder with Cloverleaf Cam 1 1/2" long. To be used with Cal-Royal NM Series Mortise locks | | | |
| | 8000 ICRIM | Schlage Large Format Interchangeable Core rim Cylinder with mounting plate and screws | | | |
| | KM-LFH-SA | Sargent Large Format Interchangeable Core Mortise cylinder with Adams Rite Cam 1 1/2" long OPTIONAL RIM PACK | US26D | | |
| | KM-LFH-CR | Corbin / Russwin Large Format Interchangeable Core Mortise cylinder with Adams Rite Cam 1 1/2" long OPTIONAL RIM PACK | | | |
| | KM-LFH-YA | YALE Large Format Interchangeable Core Mortise cylinder with Adams Rite Cam 1 1/2" long OPTIONAL RIM PACK | | | |
| | RIM PACK | Mortise-Rim Combo component parts pack | | | |
| Other CAMS available. | | | | | |

RESTRICTED KEY CONTROL REPLACEMENT CYLINDERS

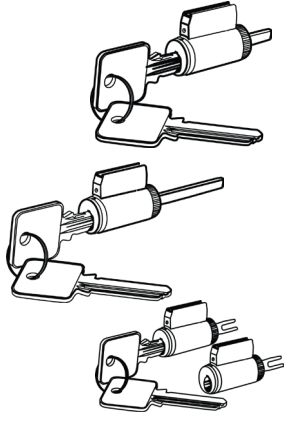
- Provide restricted key control by utilizing the HSK patented key control system
- Can be MASTER KEYED and / or KEYED ALIKE in combination with HSK HIGH SECURITY CYLINDERS
- Refer to HSK for keying changes

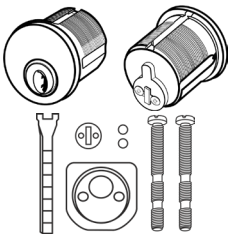
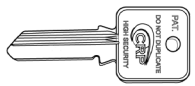
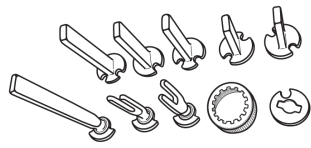
| ILLUSTRATION | ITEM# | DESCRIPTION | FINISH |
|---|-----------|---|--|
| 6-pin, 0-BITTED KEY-IN-KNOB / LEVER & DEADBOLT REPLACEMENT CYLINDERS | | | |
|  | KKCRL-6 | Key-In-Knob / Lever Replacement Cylinder 6-pin "0 Bitted" Includes 2 Standard keys / Lever Tailpiece (other tailpieces available) | For pricing & availability inquiries contact your Local Distributor or click here for the list of our Sales Reps |
| | KKCRLSD-6 | Single Cylinder Deadbolt Replacement Cylinder 6-pin "0 Bitted" Includes 2 keys | |
| | KKCRLDD-6 | Double Cylinder Deadbolt Replacement Cylinder (2 required) 6-pin "0 Bitted" Includes 2 keys | |
| 7-pin, UNCOMBINED REPLACEMENT CYLINDER / SMALL FORMAT IC CYLINDERS | | | |
|  | 7PUCCRS | Uncombined Small Format Interchangeable Core Conventional SFIC, 7-pin Does not include keys | For pricing & availability inquiries contact your Local Distributor or click here for the list of our Sales Reps |
| 6-pin, 0-BITTED MORTISE / RIM CYLINDERS | | | |
|  | KMCRL-4 | 1 1/4" 6-pin "0 Bitted" Mortise Cylinder, comes with Adams Rite Cam. Other cams are available as HSK Includes 2 keys. OPTIONAL RIM PACK | For pricing & availability inquiries contact your Local Distributor or click here for the list of our Sales Reps |
| | RIM PACK | Mortise-Rim Combo component parts pack | |
| KEY BLANKS | | | |
|  | KBCRL-6 | Key Blanks for use with Full Size replacement cylinders 50 pieces per box | For pricing & availability inquiries contact your Local Distributor or click here for the list of our Sales Reps |
| | KBCRS-7 | Key blanks for use with 7PUCCRS Small Format Interchangeable Cores. 50 pieces per box | |
| TAILPIECE KIT | | | |
|  | KT-H-PK | <ul style="list-style-type: none"> • KIKLCAP-01 • KIKLCAP-02 • LZTPSD-01 • LZTPDD-01 • LZTPDD-02 • TPWASHER • KIKLZTP-01 • KIKLZTP-02 • KIKLZTP-03 • KIKLZTP-04 • KIKLZTP-05 • KIKLZTP-06 | For pricing & availability inquiries contact your Local Distributor or click here for the list of our Sales Reps |

US26D

CRP HSK HIGH SECURITY

EXCLUSIVE PATENTED SIDE BAR KEYWAY

MEETS
The Buy American Act

| ILLUSTRATION | ITEM # | DESCRIPTION | FINISH |
|---|---|--|--|
| | KIKL5 (Includes 2 Keys and all Tailpieces & Caps shown) | Universal 5-pin Grade 3 0-bitted 0B Key-In-Knob / Lever & Deadbolt Cylinder | US26D, US3 |
| | | Universal 5-pin Keyed Different KD Grade 3 Key-In-Knob / Lever & Deadbolt Cylinder | |
| | KIKL6 (Includes 2 Keys and all Tailpieces & Caps shown) | UL-Listed Universal 6-pin 0-bitted 0B Key-In-Knob / Lever & Deadbolt Cylinder | |
| | | UL-Listed Universal 6-pin Keyed Different KD Key-In-Knob / Lever & Deadbolt Cylinder | |
| | ULKIKL (Includes 2 Keys and all Tailpieces & Caps shown) | UL-Listed Universal 6-pin 0-bitted 0B Key-In-Knob / Lever & Deadbolt Cylinder | |
| | | UL-Listed Universal 6-pin Keyed Different KD Key-In-Knob / Lever & Deadbolt Cylinder | |
| | LFIC6 (Includes 2 Keys) | 6-pin 0-bitted 0B Schlage Large Format Interchangeable Core | For pricing & availability inquiries contact your Local Distributor or click here for the list of our Sales Reps |
| | | 6-pin Keyed Different KD Schlage Large Format Interchangeable Core | |
| | ULLFIC6 (Includes 2 Keys) | UL-Listed 6-pin "A" 0-bitted 0B Schlage Large Format Interchangeable Core | |
| | | UL-Listed 6-pin "A" Keyed Different KD Schlage Large Format Interchangeable Core | |
| | SFIC7 (Includes 2 Keys) | 7-pin 0-bitted 0B Small Format Interchangeable Core Cylinder | |
| | | 7-pin Keyed Different KD Small Format Interchangeable Core Cylinder | |
| | ANSFIC7 (Includes 2 Keys) | ANSI / BHMA A156.30 certified 7-pin 0-bitted 0B "A" Small Format Interchangeable Core Cylinder | |
| | | ANSI / BHMA A156.30 certified 7-pin 0-bitted KD "A" Small Format Interchangeable Core Cylinder | |
| <p>Adams Rite Cam Standard</p> <p>RIM PACK</p> | MRC114 (Includes 2 Keys) | 6-pin 1 1/4" 0-bitted 0B Mortise-Rim Combination Cylinder Rim Pack Included | US26D |
| | | 6-pin 1 1/4" 0-bitted KD Mortise-Rim Combination Cylinder Rim Pack Included | |
| | ULMRC114 (Includes 2 Keys) | UL-Listed 6-pin 1 1/4" "A" 0-bitted 0B Mortise-Rim Combination Cylinder Rim Pack Included | |
| | | UL-Listed 6-pin 1 1/4" "A" Keyed Different KD Mortise-Rim Combination Cylinder Rim Pack Included | |
| | MRC118 (Includes 2 Keys) | 6-pin 1 1/8" 0-bitted 0B Mortise-Rim Combination Cylinder Rim Pack Included | |
| | | 6-pin 1 1/8" Keyed Different KD Mortise-Rim Combination Cylinder (Rim Pack Included) | |
| | ULMRC118 (Includes 2 Keys) | UL-Listed 6-pin 1 1/8" "A" 0-bitted 0B Mortise-Rim Combination Cylinder. (Rim Pack Included) | |
| | | UL-Listed 6-pin 1 1/8" "A" Keyed Different KD Mortise-Rim Combination (Rim Pack Included) | |
| MRCLFIC-2-H (Rim Pack Included) | Mortise-Rim Combination Small Format IC Housing Adams Rite Cam Standard | | |
| MRCSFIC-1-H (Rim Pack Included) | Mortise-Rim Combination Small Format IC Housing Adams Rite Cam Standard | | |
| | KBL5 | 5-pin sidebar keyway Key Blank For Key-In-Knob / Lever, Schlage LFIC and Mortise / Rim Cylinders | |
| | KBL6 | 6-pin sidebar keyway Key Blank For Key-In-Knob / Lever, Schlage LFIC and Mortise / Rim Cylinders | |
| | KBLSF7 | 7-pin sidebar keyway Key Blank For Small Format Interchangeable Core | |
| | KCK6 | Schlage LFIC, 6-pin Key-In-Knob / Lever and Mortise / Rim Cylinder sidebar keyway Control Key | |

Standard Schlage Pinning kits are used for all cylinders except for Small Format, which uses Best pinning kits

CRP HSK HIGH SECURITY

ACCESSORIES

| ILLUSTRATION | ITEM # | DESCRIPTION | PACK QUANTITY |
|---|---|---|---------------|
| MORTISE-RIM CYLINDER COMBO and Small Format IC Housing COMPONENTS (NON-UL) | | | |
| | CAMADAM-1 | Adams Rite Cam | 5 |
| | CAMYALE-2 | Yale Wide Cam | 5 |
| | CAMYALE-2A | Yale Standard Cam | 5 |
| | CAMRUSS-3 | Corbin Russwin Cam | 5 |
| | CAMFLCN-4 | Falcon Cam | 5 |
| | CAMCRP-6 | Cal-Royal NM Series Mortise Lock Cam | 5 |
| | CAMSCHL-7 | Schlage Cam | 5 |
| | CAMSGNT-8 | Sargent Offset Cam | 5 |
| CAMSCREW | Cam Screw | 25 | |
| MORTISE AND KIKL CYLINDER COMPONENTS (NON-UL) | | | |
| | SIDEBAR-1 | Side Bar | 10 |
| | SPIN1 | Side Pin #1 | 10 |
| | SPIN2 | Side Pin #2 | 10 |
| | SPIN3 | Side Pin #3 | 10 |
| | SPIN4 | Side Pin #4 | 10 |
| | SIDEBARSPRING | Spring for Side Bar | 20 |
| | KIKSPRING | Spring for Screw Cap | 25 |
| | MRTPINSPRING | Mortise Pin Spring | 50 |
| | KIKPINSPRING | Top Pin Spring | 50 |
| | LZTPSD-01 | Lazy Tailpiece Long for Single Cylinder | 10 |
| | LZTPDD-01 | Lazy Tailpiece Short for Double Cylinder Black | 10 |
| | LZTPDD-02 | Lazy Tailpiece Short for Double Cylinder Gold | 10 |
| | TPWASHER | Black Washer to retain Long Tailpiece LZTPSD-01 | 10 |
| | KIKLZTP-01 | Lazy Tailpiece for Knob / Lever $\frac{5}{8}$ " | 5 |
| | KIKLZTP-02 | Lazy Tailpiece for Knob / Lever $\frac{5}{8}$ " | 5 |
| | KIKLZTP-03 | Lazy Tailpiece for Knob / Lever $\frac{7}{8}$ " | 5 |
| | KIKLZTP-04 | Lazy Tailpiece for Knob / Lever $\frac{15}{16}$ " | 5 |
| KIKLZTP-05 | Lazy Tailpiece for Knob / Lever $1 \frac{5}{32}$ " | 5 | |
| KIKLZTP-06 | Lazy Tailpiece for Knob / Lever $1 \frac{5}{32}$ " Narrow Tip | 5 | |
| | ALLNSCRW-BLK | Allen Screw Black | 25 |
| | KIKPIN | Pin for Screw Cap | 25 |
| | KIKLCAP-01 | KIKL Cap Long | 10 |
| | KIKLCAP-02 | KIKL Cap Short | 10 |
| | MSHRMTPIN | Mushroom Top Pin | 50 |
| | RIM PACK | Mortise-Rim Combo component parts pack | 1 |
| SMALL FORMAT INTERCHANGEABLE CORE (SFIC) CYLINDER HOUSING COMPONENTS | | | |
| | SFICSPIN1 | SFIC Side Pin #1 | 10 |
| | SFICSPIN2 | SFIC Side Pin #2 | 10 |
| | SFICSPIN3 | SFIC Side Pin #3 | 10 |
| | SFICSIDEBAR | SFIC Side Bar | 10 |
| | SFICCCLIP | SFIC "C" Clip | 25 |
| | SFICSBSPR | SFIC Side Bar Spring | 25 |
| | SFICALLNSCRW | SFIC Allen Screw | 25 |
| | SFICSPR | SFIC Pin Spring | 50 |

For pricing & availability inquiries contact your Local Distributor or click [here](#) for the list of our Sales Reps

For pricing & availability inquiries contact your Local Distributor or click [here](#) for the list of our Sales Reps

For pricing & availability inquiries contact your Local Distributor or click [here](#) for the list of our Sales Reps

Standard Schlage Pinning kits are used for all cylinders except for Small Format, which uses Best pinning kits

MEETS
The Buy American Act

CRP HSK HIGH SECURITY ACCESSORIES

MEETS
The Buy American Act

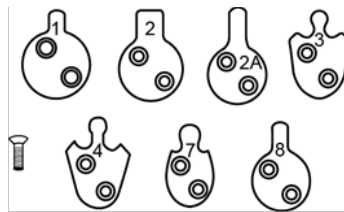
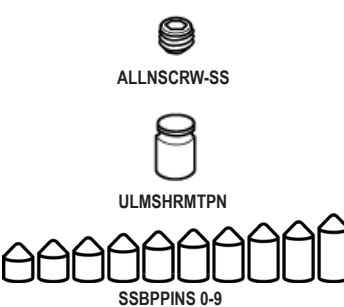
| ILLUSTRATION | ITEM # | DESCRIPTION | PACK QUANTITY | |
|--|----------------|---|---------------|--|
| LARGE FORMAT INTERCHANGEABLE CORE (LFIC) CYLINDER HOUSING COMPONENTS | | | | |
|  | LFCAMADAM-1 | LFIC Adams Rite Cam | 5 | For pricing & availability inquiries contact your Local Distributor or click here for the list of our Sales Reps |
| | LFCAMYALE-2 | LFIC Yale Wide Cam | 5 | |
| | LFCAMYALE-2A | LFIC Yale Standard Cam | 5 | |
| | LFCAMRUSS-3 | LFIC Corbin Russwin Cam | 5 | |
| | LFCAMFLCN-4 | LFIC Falcon Cam | 5 | |
| | LFCAMSCHL-7 | LFIC Schlage Cam | 5 | |
| | LFCAMSCRW | LFIC Cam Screw | 15 | |
| MORTISE-RIM CYLINDER COMBO and Small Format IC Housing COMPONENTS (UL-LISTED) | | | | |
|  | ULCAMADAM-1 | UL-Listed Adams Rite Cam | 5 | For pricing & availability inquiries contact your Local Distributor or click here for the list of our Sales Reps |
| | ULCAMYALE-2 | UL-Listed Yale Wide Cam | 5 | |
| | ULCAMYALE-2A | UL-Listed Yale Standard Cam | 5 | |
| | ULCAMRUSS-3 | UL-Listed Corbin Russwin Cam | 5 | |
| | ULCAMFLCN-4 | UL-Listed Falcon Cam | 5 | |
| | ULCAMSCHL-7 | UL-Listed Schlage Cam | 5 | |
| | ULCAMSGNT-8 | UL-Listed Sargent Offset Cam | 5 | |
| | CAMSCREW | Cam Screw | 25 | |
| MORTISE AND KIKL CYLINDER COMPONENTS (UL-LISTED) | | | | |
|  | ALLNSCRW-SS | Allen Screw Stainless Steel | 25 | For pricing & availability inquiries contact your Local Distributor or click here for the list of our Sales Reps |
| | ULMSHRMTPIN | UL-Listed Mushroom Top Pin | 50 | |
| | SSBPIN0 | Stainless Steel Bottom Pin#0 | 12 | |
| | SSBPIN1 | Stainless Steel Bottom Pin#1 | 12 | |
| | SSBPIN2 | Stainless Steel Bottom Pin#2 | 12 | |
| | SSBPIN3 | Stainless Steel Bottom Pin#3 | 12 | |
| | SSBPIN4 | Stainless Steel Bottom Pin#4 | 12 | |
| | SSBPIN5 | Stainless Steel Bottom Pin#5 | 12 | |
| | SSBPIN6 | Stainless Steel Bottom Pin#6 | 12 | |
| | SSBPIN7 | Stainless Steel Bottom Pin#7 | 12 | |
| | SSBPIN8 | Stainless Steel Bottom Pin#8 | 12 | |
| | SSBPIN9 | Stainless Steel Bottom Pin#9 | 12 | |
| OTHER ACCESSORIES | | | | |
| SEE NEXT PAGE | REGCARD | High Security Plastic Registration Card | 10 | For pricing & availability inquiries contact your Local Distributor or click here for the list of our Sales Reps |
| | KITPARTS-1 | Parts Kit for CRP High Security | 1 | |
| | KITSTDPIN-2 | Standard Pin Kit for CRP High Security | 1 | |
| | KITULPIN-3 | UL-Pinning Kit for CRP High Security | 1 | |
| | KITULPIN-4 | UL-Parts Kit for CRP High Security | 1 | |
| | KITSFICPARTS-5 | SFIC Parts | 1 | |
| | KITCAMS-6 | Small & Large Format Cams UL & Non-UL | 1 | |

Standard Schlage Pinning kits are used for all cylinders except for Small Format, which uses Best pinning kits

CRP HSK HIGH SECURITY ACCESSORIES

MEETS
The Buy American Act

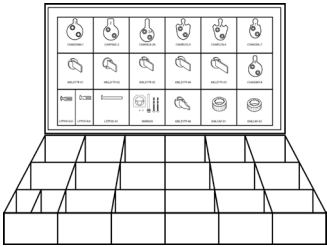
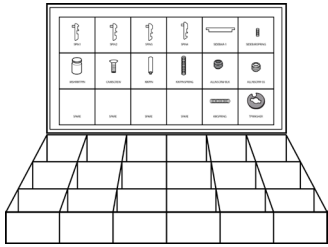
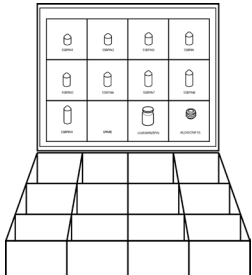
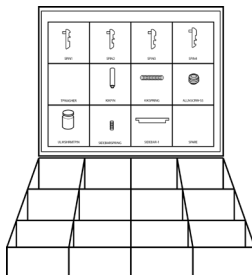
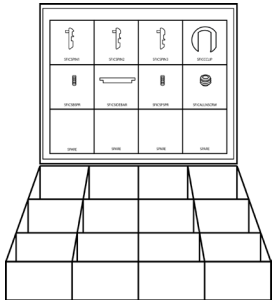
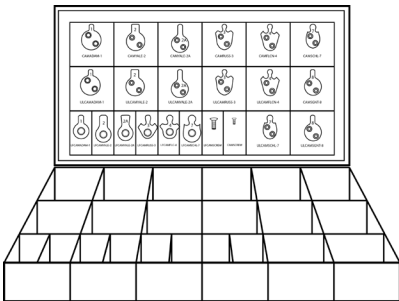
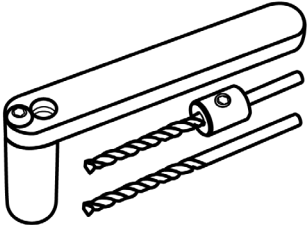
| KITPARTS-1 | KITSTDPIN-2 | |
|---|---|---|
|  <p>CAMADAM-1 x 10, CAMYALE-2 x 10, CAMYALE-2A x 10, CAMRUSS-3 x 10, CAMFLCN-4 x 10, CAMSCHL-7 x 10, CAMSGNT-8 x 10, KIKLCAP-01 x 10, KIKLCAP-02 x 10, RIMPACK x 2, KIKLZTP-01 x 5, KIKLZTP-02 x 5, KIKLZTP-03 x 5, KIKLZTP-04 x 5, KIKLZTP-05 x 5, KIKLZTP-06 x 5, LZTPDD-BLK x 20, LZTPDD-GLD x 20, LZTPSD-01 x 10</p> |  <p>ALLNSCRW-SS x 25, ALLNSCRW-BLK x 25, KIKPINSRING x 100, KIKSPRING x 25, CAMSCREW x 25, SIDEBAR-1 x 10, MSHRMTPIN x 50, KIKPIN x 25, SPIN1 x 10, SPIN2 x 10, SPIN3 x 10, SPIN4 x 10, TPWASHER x 10, SIDEBARSRING x 20</p> | |
| KITULPIN-3 | KITULPIN-4 | KITSFICPARTS-5 |
|  <p>SSBPIN0 x 24, SSBPIN1 x 24, SSBPIN2 x 24, SSBPIN3 x 24, SSBPIN4 x 24, SSBPIN5 x 24, SSBPIN6 x 24, SSBPIN7 x 24, SSBPIN8 x 24, SSBPIN9 x 24, ULMHRMTPIN x 50, ALLNSCRW-SS x 25</p> |  <p>SPIN1 x 20, SPIN2 x 20, SPIN3 x 20, SPIN4 x 20, TPWASHER x 20, KIKPIN x 25, KIKSPRING x 25, ALLNSCRW-SS x 25, ULMHRMTPIN x 100, SIDEBARSRING x 20, SIDEBAR-1 x 10</p> |  <p>SFICSPIN1 x 20, SFICSPIN2 x 20, SFICSPIN3 x 20, SFICCLIP x 25, SFICSPR x 50, SFICSIDEBAR x 10, SFICBSPR x 25, SFICALLNSCRW x 25</p> |
| KITCAMS-6 | KZHSK COT | |
|  <p>LFCAMADAM-1 x 5, LFCAMFLCN-4 x 5, LFCAMRUSS-3 x 5, LFCAMSCHL-7 x 5, LFCAMSCRW x 30, LFCAMYALE-2 x 5, LFCAMYALE-2A x 5, MRTPINSRING x 50, ULCAMADAM-1 x 5, ULCAMFLCN-4 x 5, ULCAMRUSS-3 x 5, ULCAMSCHL-7 x 5, CAMSCREW x 25, ULCAMSGNT-8 x 5, ULCAMYALE-2 x 5, ULCAMYALE-2A x 5, CAMADAM-1 x 5, CAMYALE-2 x 5, CAMYALE-2A x 5, CAMRUSS-3 x 5, CAMFLCN-4 x 5, CAMSCHL-7 x 5, CAMSGNT-8 x 5</p> |  <p>DRIVE PIN CUT OFF TOOL (Used for converting regular SFIC Housing for use with HSK SFIC Cylinders)</p> | |

CRP HSK HIGH SECURITY

HSK HEAVY DUTY GRADE 1 DEADBOLTS

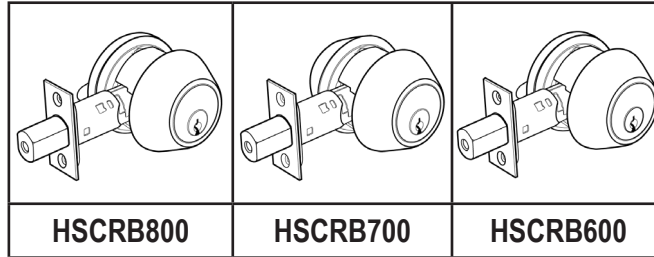

| FUNCTION | ANSI | ITEM # | US26D | US3, 15 | US10B | US4, 5, 26 | PCS / MC |
|--|-------|----------|--|---------|-------|------------|----------|
| Grade 1, UL Listed, "HSK" Keyway Single Cylinder Deadbolt | E0152 | HSCRB800 | For pricing & availability inquiries contact your Local Distributor or click here for the list of our Sales Reps | | | | 20 |
| Grade 1, UL Listed, "HSK" Keyway Double Cylinder Deadbolt | E0142 | HSCRB700 | | | | | |
| Classroom Deadbolt lock, Deadbolt thrown or retracted by key outside. Inside turn unit will retract bolt only. Bolt automatically deadlocks when fully thrown | F109 | HSCRB600 | | | | | |

HSK HEAVY DUTY GRADE 2 DEADBOLTS

| UL-LISTED | | | NON-UL | |
|---------------------------|-----------------|-----------------|----------------|----------------|
| | | | | |
| HSULT360 / HSCL600 | HSULT362 | HSULT700 | HSCB160 | HSCB162 |

| FUNCTION | ANSI | ITEM # | US3 | US26D | US10B | US4 | US15 | US26, US10 | US5 | PCS / MC |
|--|-------|----------|--|-------|-------|-----|------|------------|-----|----------|
| Heavy Duty Single Cylinder Deadbolt, UL Listed | E0152 | HSULT360 | For pricing & availability inquiries contact your Local Distributor or click here for the list of our Sales Reps | | | | | | | 20 |
| Heavy Duty Double Cylinder Deadbolt, UL Listed | E0142 | HSULT362 | | | | | | | | |
| Classroom deadbolt lock UL Listed | E0172 | HSCL600 | | | | | | | | |
| One-Way Deadbolt Lock UL Listed | E1161 | HSULT700 | | | | | | | | 36 |
| Heavy Duty Single Cylinder Deadbolt | E0152 | HSCB160 | | | | | | | | |
| Heavy Duty Double Cylinder Deadbolt | E0142 | HSCB162 | | | | | | | | |

CRP COMBI KEY SYSTEM

EXCLUSIVE PATENTED COMBINATION KEYWAY

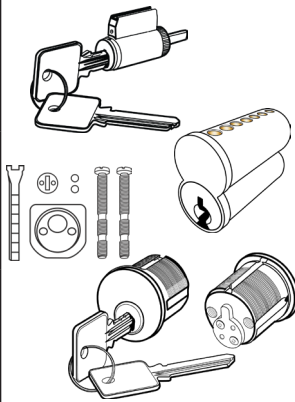
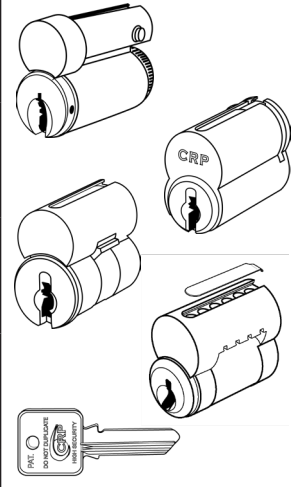
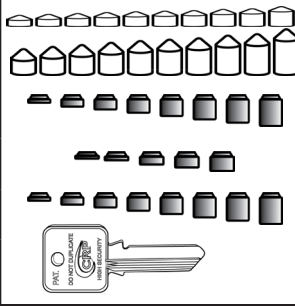
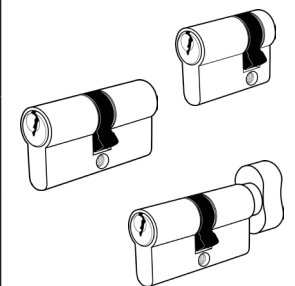
| ILLUSTRATION | ITEM # | DESCRIPTION | FINISH | |
|---|---|---|--|--|
|  | KK-COS-NS (Includes 2 Keys and all Tailpieces & Caps shown) | Key-In-Knob / Lever Replacement Cylinder, 6-pin "0-bitted". Includes 2 keys / Lever Tailpiece. (other tailpieces available on request) | For pricing & availability inquiries contact your Local Distributor or click here for the list of our Sales Reps | |
| | 6PUC-COS (NO keys included) | Uncombined Small Format Interchangeable Core Conventional SFIC, 6-pins. Does not include keys. | | |
| | KM-COS-4 (Includes 2 Keys and all Tailpieces & Caps shown) | 1 1/4" 6-pin "0-bitted" Mortise Cylinder. Cylinder comes with Adams Rite Cam - other cams are available as HSK. Optional Rim Conversion Package available. See page L107 (RIM PACK) . Includes 2 keys. | | |
|  | KL-COS-SC (Includes 2 Keys) | Schlage Large Format, 6-pin "0-bitted". Includes 2 keys. | | |
| | KL-COS-YA (Includes 2 Keys) | Yale Combi 6-pin Large Format IC control key for Schlage and Yale Large Format 6-pin uncombined. Does not include keys. | | |
| | KL-COS-SA (Includes 2 Keys) | Sargent Combi 6-pin Large Format IC control key for Schlage and Yale Large Format 6-pin uncombined. Does not include keys. | | |
| | KL-COS-CR (Includes 2 Keys) | Corbin / Russwin Large Format uncombined. Does not include keys. | | |
| | COSCK | Combi Control Key for LFIC (Schlage and Yale cores). | | |
|  | KP-I | Combi SFIC (Best / Falcon A-2 Pins) | | |
| | KP-C2 | Combi Large Diameter Cylinders (A-2 Pinning) | | |
| | KP-I4 | Combi SFIC (Best / Falcon A-4 Pins) | | |
| | KP-C4 | Combi Large Diameter Cylinders (A-4 Pinning) | | |
| | KBCOS6 | Combi 6-pin key blank | | |
| EUROPEAN PROFILE CYLINDERS | | | | |
|  | KE-COS-S (Includes 2 Keys) | 1 3/4" (45mm) length, 6-pin standard, 0-bitted. 2 keys included. Half Cylinder | | For pricing & availability inquiries contact your Local Distributor or click here for the list of our Sales Reps |
| | KE-COS-D (Includes 2 Keys) | 2 3/4" (70mm) length, 6-pin standard, 0-bitted. 2 keys included. Double Cylinder | | |
| | KE-COS-C (Includes 2 Keys) | 2 3/4" (70mm) length, 6-pin standard, 0-bitted. 2 keys included. Thumbturn Cylinder | | |

US26D

US26D

CRP COMBI PINNING KITS

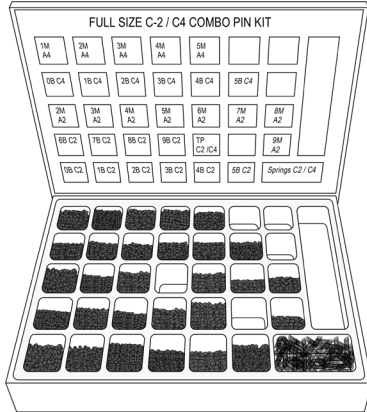

COMBI C2 / C4 Full Size Pinning Kit
DUAL COMBI A2 / A4 / C2 / C4
Small Format & Full Size Pinning Kit

CRP PINNING KIT FOR COMBI CYLINDERS

| KP-I <ul style="list-style-type: none"> • SFIC pins for keying (same as BEST A2) | KP-I4 <ul style="list-style-type: none"> • SFIC pins for keying (same as BEST A4) | KP-C2 <ul style="list-style-type: none"> • Full size pins C2 large diameter cylinders | KP-C4 <ul style="list-style-type: none"> • Full size pins C4 large format diameter cylinders |
|---|---|--|--|
| A2 SFIC PINS | A4 SFIC PINS | C2 FULL SIZE PINS | C4 FULL SIZE PINS |
| (2-19) Master Pins KP-I-2M KP-I-8M KP-I-14M KP-I-3M KP-I-9M KP-I-15M KP-I-4M KP-I-10M KP-I-16M KP-I-5M KP-I-11M KP-I-17M KP-I-6M KP-I-12M KP-I-18M KP-I-7M KP-I-13M KP-I-19M | (1-11) Master Pins <ul style="list-style-type: none"> • KP-I4-1M • KP-I4-6M • KP-I4-2M • KP-I4-8M • KP-I4-3M • KP-I4-9M • KP-I4-4M • KP-I4-10M • KP-I4-5M • KP-I4-11M | (2-9) Master Pins <ul style="list-style-type: none"> • KP-C2-2M • KP-C2-6M • KP-C2-3M • KP-C2-7M • KP-C2-4M • KP-C2-8M • KP-C2-5M • KP-C2-9M | (1-5) Master Pins <ul style="list-style-type: none"> • KP-C4-1M • KP-C4-2M • KP-C4-3M • KP-C4-4M • KP-C4-5M |
| (0-9) Bottom Pins <ul style="list-style-type: none"> • KP-I-0B • KP-I-5B • KP-I-1B • KP-I-6B • KP-I-2B • KP-I-7B • KP-I-3B • KP-I-8B • KP-I-4B • KP-I-9B | (0-5) Bottom Pins <ul style="list-style-type: none"> • KP-I4-0B • KP-I4-3B • KP-I4-1B • KP-I4-4B • KP-I4-2B • KP-I4-5B | (0-9) Bottom Pins <ul style="list-style-type: none"> • KP-C2-0B • KP-C2-5B • KP-C2-1B • KP-C2-6B • KP-C2-2B • KP-C2-7B • KP-C2-3B • KP-C2-8B • KP-C2-4B • KP-C2-9B | (0-5) Bottom Pins <ul style="list-style-type: none"> • KP-C4-0B • KP-C4-3B • KP-C4-1B • KP-C4-4B • KP-C4-2B • KP-C4-5B |

ACCESSORIES

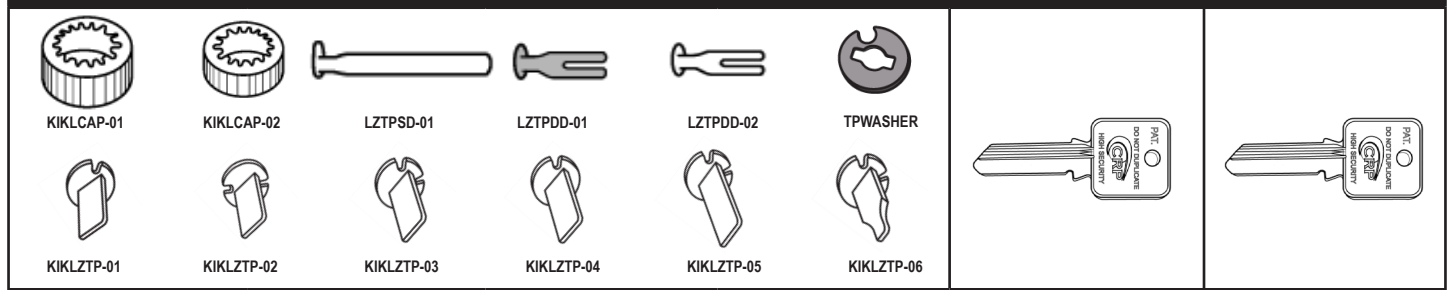

| | | | | |
|---|--|--|--|--|
| KT-H-PK <ul style="list-style-type: none"> • KIKLCAP-01 • KIKLCAP-02 • LZTPSD-01 • LZTPDD-01 • LZTPDD-02 • TPWASHER | <div style="border: 1px solid black; padding: 5px; width: fit-content; margin: 0 auto;"> SEE PAGE L109 FOR PRICING </div> | <ul style="list-style-type: none"> • KIKLZTP-01 • KIKLZTP-02 • KIKLZTP-03 • KIKLZTP-04 • KIKLZTP-05 • KIKLZTP-06 | KBCOS6 COMBI 6-pin key blank | COSCK COMBI 6-pin Large Format IC control key for Schlage and Yale |
|---|--|--|--|--|

KEYS & KEYING ...

For Commercial Grade Locksets

COMMERCIAL LOCKSETS, CONVENTIONAL CYLINDER KEYING (NOT INCLUDING RESIDENTIAL LOCKSETS)

| ITEM # | DESCRIPTION | |
|----------------------|--|--|
| KA | Key Alike / 0-bitted | For pricing & availability inquiries contact your Local Distributor or click here for the list of our Sales Reps |
| MK | Master Keying (Including KA) | |
| GMK | Grand Master Keying (Including KA & MK) | |
| GGMK | Grand Grand Master Keying (Including KA & MK) | |
| CMK | Construction Master Keying (Including KA & MK) N/A on HSK & COMBI | |
| KM | Key Marking letters or numbers (AA1, AA2, ...) on key bow or cylinder core | |
| DND | Do Not Duplicate | |
| CMARK | Cylinder Marking | |
| ECK | Extra Cut Key (2 keys standard per lock) | |
| CECK | Extra Cut Combi Keys (2 keys standard per lock) | |
| HECK | Extra Cut High Security Keys (2 keys standard per lock) HSK | |
| CRSC15 | Schalge "C" Key Blanks (5 pins) | |
| CRSC16 | Schalge "C" Key Blanks (6-pins) | |
| CRKW1 | Kwikset Key Blanks (5 pins) | |
| ◆ KEYING KITS | | |
| KKC100 | Keying Kit - "C" Keyway | For pricing & availability inquiries contact your Local Distributor or click here for the list of our Sales Reps |
| KKWI200 | Keying Kit - KWI Keyway | |

See Keying Policies at our website regarding keying systems

COMMERCIAL LOCKSETS INTERCHANGEABLE CORE (LFIC, SFIC) KEYS & KEYING

| | | | |
|----------|--|--|--|
| ICKA | Key Alike / 0-bitted | For pricing & availability inquiries contact your Local Distributor or click here for the list of our Sales Reps | |
| ICMK | Master Keying (Including KA) | | |
| ICGMK | Grand Master Keying (Including KA & MK) | | |
| ICGGMK | Grand Grand Master Keying (Including KA, MK & GMK) | | |
| IECK | SFIC Extra Cut Keys | | |
| CONKEY | Extra Cut Control Keys for Best Falcon and Arrow | | Two control keys are supplied with each Masterkey System |
| CONKEY-1 | Extra Cut Control Keys for Schlage "C" | | |
| CONKEY-2 | Extra Cut Control Keys for Schlage "E" | | |
| CONKEY-3 | Extra Cut Control Keys for Yale "GA" | | |
| KB-LF-GA | Control Key Blank for Yale "GA" | | |
| KB-LF-SC | Control Key Blank for Schlage "C" | | |
| KB-LF-SE | Control Key Blank for Schlage "E" | | |

For HSK, CRL, CRS and COMBI Cylinders see HSK Service Manual on our website

OTHER ACCESSORIES

| ITEM # | DESCRIPTION | |
|-----------|--|--|
| PDBFLS | Plastic Dust box for Full Lip Strike | For pricing & availability inquiries contact your Local Distributor or click here for the list of our Sales Reps |
| PDB1214 | Plastic Dust box for Residential Deadbolt Strike 1" x 2 1/4" | |
| PDB118234 | Plastic Dust box for T-Strike 1 1/8" x 2 3/4" | |
| PDBTS | Plastic Dust box for Deadbolt T2STRK Strike | |
| PDB478 | Plastic Dust box for ASA Strike | |
| LFA18 | Latch front adapter to convert 1" plate to 1 1/8" wide door preparations (Clear) | |

RESIDENTIAL KEYING

| KEYING | | |
|--------|---|--|
| ITEM # | DESCRIPTION | |
| KARES | Key alike | For pricing & availability inquiries contact your Local Distributor or click here for the list of our Sales Reps |
| MKRES | Master key (Including KA) | |
| CMKRES | Builder construction master key (Including KA & MK) | |
| GMKRES | Grand master key (Including KA, MK) | |