

## BARRINGTON BA Series List Price

### STANDARD DUTY CYLINDRICAL LOCKSETS

### ANSI A156.2 Series 4000 Grade 2

Optional Interchangeable Core for **Best, Falcon and Arrow**

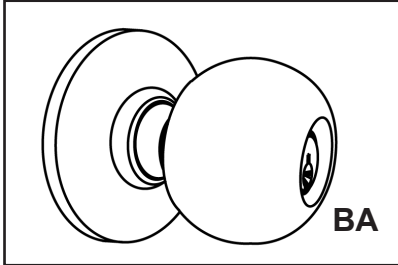

**LIFETIME WARRANTY**

**MEETS**  
*The Buy American Act*

**QUANTITY DISCOUNT**  
**50 UNITS MIXED ▶▶ LESS 5%**  
**100 UNITS MIXED ▶▶ LESS 10%**

Made in Korea				
FUNCTION	ANSI	ITEM #	FINISH	PCS / MC
Entrance *****KA/4	F109	BA00	US32D, 10B, 3, 10, 4, 26	20
		● ICBA00		
Combination Entrance and Single Cylinder Deadbolt -- KA / 2 packed together	NEW ITEM	BA00 / T220		
		BA03		
Classroom	F84	● ICBA03		
		BA05		
Storeroom	F86	● ICBA05		
		BA04		
Communicating	F80	BA09		
Institution	F87	BA20		
Privacy	F76	BA30		
Passage	F75	BA50		
Exit	F89	BA40		
Single Dummy	----	BA40	50	

Made in Taiwan				
FUNCTION	ANSI	ITEM #	FINISH	PCS / MC
Entrance *****KA / 4	F109	TBA00	US32D, 10B, 3, 10, 4, 26, 19	20
		● ICTBA00		
Classroom	F84	TBA03		
		● ICTBA03		
Storeroom	F86	TBA05		
		● ICTBA05		
Storelock	F91	● TBA02		
Communicating	F80	TBA04		
Institution	F87	TBA09		
Privacy	F76	TBA20		
Passage	F75	TBA30		
Exit	F89	TBA50		
Single Dummy	----	TBA40		50

## BARRINGTON BA Series List Price

### STANDARD DUTY CYLINDRICAL LOCKSETS

#### ANSI A156.2 Series 4000 Grade 2



**LIFETIME WARRANTY**

**MEETS**  
*The Buy American Act*

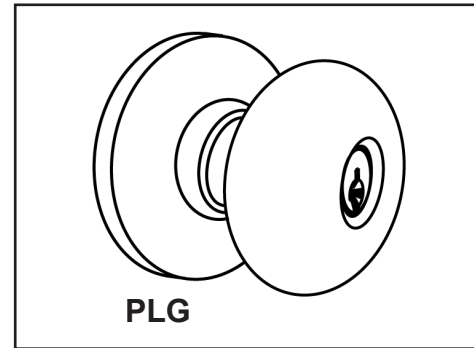
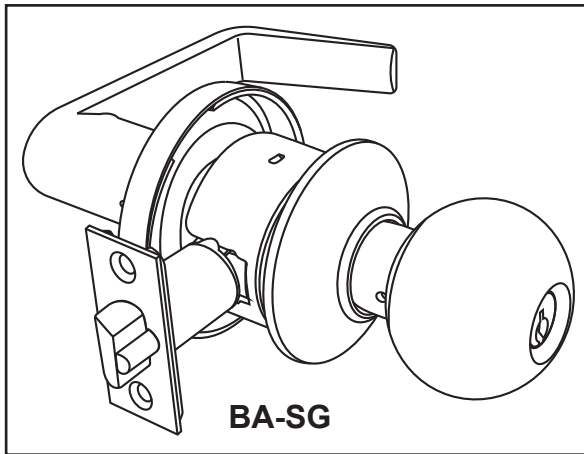

FUNCTION	ANSI	ITEM #	FINISH	PCS / MC
Storeroom <b>NEW ITEM</b>	F86	BA-SG05	US32D, 3, 10B, 4, 10	10
Entrance *****KA / 4	F109	PLG00	US32D, 3, 10B, 4, 10	20
Classroom	F84	PLG03		
Storeroom	F86	PLG05		
Storelock	F91	PLG02		
Communicating	F80	PLG04		
Institution	F87	PLG09		
Privacy	F76	PLG20		
Passage	F75	PLG30		
Exit	F89	PLG50		
Single Dummy	----	PLG40		

► **BA / PLG PACKAGING INCLUDES**

- Standard "C", 6-pin cylinder
- UL Listed 2 3/4" Backset
- 2 1/4" x 1 1/8" faceplate and ASA Strike

► **BA-SG PACKAGING INCLUDES**

- Standard "C", 6-pin cylinder
- 2 3/8" Backset
- 2 1/4" x 1" Faceplate and T-Strike

► **KEYWAYS**

6-pin solid brass "C" keyway standard. Optional: Schlage E, Schlage C-K, Russwin D1-2-3-4, Corbin 59 / 60, Corbin-Russwin L4, Sargent LA-LB-LC, Falcon / Weiser E, Arrow A, Yale 8, Yale GA and Kwikset. Can also accept Medeco, Assa, Kaba and **Cal-Royal HSK** High Security Cylinders. See **page L124** for keying charges and Cylinder PART #.

► **IC CORES, KEYING CHARGES**

For IC Core pricing see pages L114 – L115.  
 For Keying charges see **L124**.





► **TACTILE / LEAD LINING**

- Lead Lining Part # **LEAD**, Add \$137.65 List
- Tactile Part # **TAC**, Add \$28.05 List

**QUANTITY DISCOUNT**  
**50 UNITS MIXED ►► LESS 5%**  
**100 UNITS MIXED ►► LESS 10%**

► **ADDITIONAL PARTS & CHARGES FOR BARRINGTON AND POLYGON SERIES**

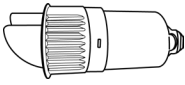
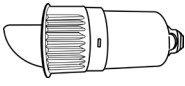
**Backsets:** UL listed 2 3/8", (2 1/4" x 1") faceplate, **NO EXTRA CHARGE** if ordered with lock only. Otherwise \$12.40 List Each.

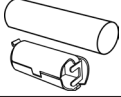
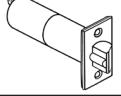
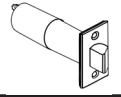
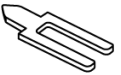
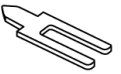
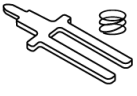
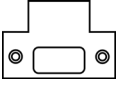
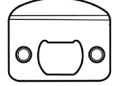
◆◆ STANDARD DISCOUNT ONLY ◆◆			
ILLUSTRATION	ITEM #	DESCRIPTION	FINISH
	ULSLD238	BA Series UL-listed Dead Latch 2 3/8" PLG Series UL-listed Dead Latch 2 3/8" 2 1/4" x 1" Faceplate	US3, 32D, 10B
	ULSLS238	BA Series UL-listed Spring Latch 2 3/8" PLG Series UL-listed Spring Latch 2 3/8" 2 1/4" x 1" Faceplate	US3, 32D, 10B
	SLDRI-1	2 3/4" Entrance, Drive-in Latch bolt for G2 Lockset	ZINC
	SLDRI-4	2 3/8" Entrance, Drive-in Latch bolt for G2 Lockset	ZINC
	SLDRI-2	2 3/4" Privacy / Passage, Drive-in Latch bolt for G2 Lockset	ZINC
	SLDRI-5	2 3/8" Privacy / Passage, Drive-in Latch bolt for G2 Lockset	ZINC
<b>EXTRA UL LISTED BACKSET</b>			
	ULSLD234	Dead Latch 2 3/4" 2 1/4" x 1 1/8" Faceplate	US3, 26D, 10B, 10, 26
	ULSLS234	Spring Latch 2 3/4" 2 1/4" x 1 1/8" Faceplate	US3, 26D, 10B, 10, 26
<b>3 3/4", 5" UL LISTED BACKSET</b>			
	SL5	5" UL listed Extension Link	----
	SLD334	BA Series 3 3/4" Dead latch PLG Series 3 3/4" Dead latch 2 1/4" x 1 1/8" Faceplate	US3, 26D, 10B
	SLS334	BA Series 3 3/4" Spring Latch PLG Series 3 3/4" Spring Latch 2 1/4" x 1 1/8" Faceplate	US3, 26D, 10B
<b>TAIL PIECE</b>			
	ICTP-03	6-pin Tail Piece for ICBA Series	-----
	ICTP-04	7 Pin Tail Piece for ICBA Series	
	ICTP-08	Tail Piece for ICTBA Only	
<b>STRIKES</b>			
	TS	T-Strike	US3, 26D, 10B, 10, 15, 26, 4
	FLS	Full Lip Strike	